

Kojtzijon

Kojtz'ib'an

Comunicación y Lenguaje Kaqchikel L'



COLECCIÓN



Rox
Rupalb'al
Tijonik

Tercero
Primaria



— No'j
5120

S.O.E (DL)
401.4
K79
V.3.

SE PROHIBE
Subrayar y/o marginar este libro,
en caso de devolverlo subrayado,
SE COBRARA SU VALOR

Kojtzijon kojtz'ib'an pa Kaqchikel Rox rupalb'al tijonik

Lenguaje y Comunicación Tercero Primaria L1

Kaqchikel sik'itz'ib'anem kichin ak'wala' e k'o
pa rox rupalb'al tijonik ri xketamaj xech'o
nab'ey pa kaqchikel ch'ab'äl



BIBLIOTECA CENTRAL (Obsequio) Q. 10.00

**Kaqchikel Moloj/Fundación Kaqchikel
K'amöl Taq b'ey /Junta Directiva**

Nab'ey K'amöl b'ey.	Presidente:	Héctor Rolando Gabriel Pichiya'
Ruka'n K'amöl b'ey.	Vicepresidente:	Julio Víctor Teleguario López
Ajtz'ib'.	Secretario:	Oswaldo Ajzalan Moráles
K'amöl b'ey pwäq.	Tesorero:	Rosalino Tichoc Cumes
Nab'ey to'onel.	Vocal I:	Ixchel, Justa Xinico Sipac
Ruka'n to'onel.	Vocal II:	Carlos Enrique Ajquiy Popol
Rox to'onel.	Vocal III:	Alejandro Asijtuj Simón

K'amöl B'ey richin ri nuk'samaj
"Runimik ri Ruchojmilal Tijonik pa taq tijonijay".
Director: Programa de Educación Bilingüe Intercultural:
"Incidencia en la Reforma Educativa desde el aula"
Leopoldo Tzian.

Re wuj re' xb'an pa Kaqchikel Moloj
Elaborado en la Fundación Kaqchikel.

Xtz'ib'an: Ambrosia Cuma.

Xeya'o na'oj richin xtz'ib'äx, chuqa' xenik'on rupam re wuj re'
Revisión y Mediación pedagógica:
María Esperanza Tuctuc Mux, José Alfredo López Sicaján,
Carlos Marcial López, Mélida Xico Esquit y Abrahám Gámez Paz.

Xnik'o rutz'ib'axik:
Kaqchikel Cholchi', Comunidad Lingüística Kaqchikel-CLK
de la Academia de Lenguas Mayas de Guatemala, ALMG.

Xeb'ano ri achib'äl: Emeterio Cuá Xicay, Julio Chalí y Hermelindo Mux.

Xeya'o na'oj, xenik'o re wuj re':
Asesoría y Revisión General: Junta Directiva de FUNKAQ y Dirección

Xkinuk' rupam re wuj:
Diseño, Diagramación e impresión
Maya Na'oj

Xeto'on rik'in ri pwäq:
Con el apoyo de Unión Europea, Ibis/Dinamarca y Niños Refugiados del Mundo

Este texto se diseñó y se produjo en coordinación con la
Dirección General de Educación Bilingüe Intercultural, DIGEBI.

FUNKAQ

2da. Calle 5-82 zona 3, Chimaltenango, Guatemala C.A.
Telefax. 8394882 Correo Electrónico: funkaq@itelgua.com

Rucholajem ri Wuj



Rupam	Ruxaq
Nab'ey taq tzij	⋮ 4
Rub'eyal Rokisaxik re Wuj re'	5
Nab'ey Tanaj: Ri Nutinamit	: 7
Ruka'n Tanaj: Rejqalem ri samaj pa qak'aslem	19
Rox Tanaj: Rokisaxik pa rub'eyal ri Kaqchikel Ch'ab'äl	• • 31
Rukaj Tanaj: Rejqalem ri Ach'alalri'il.	: • 51
Ro' Tanaj: Jalajöj Ruwäch rutzijol nuya' ri Kajulew	: : 63
Ruwaq Tanaj: Rub'anik rub'anob'al qatinamit	: 73
Ruwuq Tanaj: Rejqalem ri qati't ik' chuqa' ri qatata' q'ij pa qak'aslem	: : 83
Ruwaqxaq Tanaj: Ruxe'el ri Cholq'ij.	: 93
Rub'elej Tanaj Ri Maya' Ajilab'äl	: 103
Ch'uticholtzij	114
Ri wuj xenik'ox	• 116

47.H.C. S. n.º (2018)



Ri K'amöl B'ey richin ri Kaqchikel Cholchi', ruq'a' ri K'ulb'il Yol Twitz Paxil, nujikib'a' rutzij chuwäch re jun wuj re' chi:

Xnik'öx rutz'ib'axik ri qach'ab'äl chi kipam re wuj xkenatäx qa. Ruma k'a chi kipam ri jujun wuj kan pa rub'eyal b'anon chi re ri rutz'ib'axik ri qach'ab'äl. Re jun runik'oxik re' xb'an kuma ri rusamajela' ri Kaqchikel Cholchi'.

Richin nya'öx rejqalem re jun samaj re' nqaya' apo ri rujikib'axik qatzij pa ruwi' ri samaj.

La Infrascrita Presidenta de la Comunidad Lingüística Kaqchikel de la Academia de Lengua Mayas de Guatemala HACE CONSTAR que:

Los textos educativos que abajo se mencionan, están escritos conforme a las reglas gramaticales actuales del idioma Kaqchikel, ya que los mismos fueron sometidos al proceso de revisión establecido en la entidad, por lo que los especialistas de la misma realizaron la revisión de la escritura del idioma Kaqchikel.

Modalidad L1

1. Comunicación y lenguaje Kaqchikel L1. Ruxe' Rupalb'al Tijonik. Preprimaria.
2. Comunicación y lenguaje Kaqchikel L1. Nab'ey Rupalb'al Tijonik. Primero Primaria.
3. Comunicación y Lenguaje Kaqchikel L1. Ruka'n Rupalb'al Tijonik. Segundo Primaria
4. Comunicación y Lenguaje Kaqchikel L1 Rox Rupalb'al Tijonik. Tercero Primaria.
5. Comunicación y Lenguaje Kaqchikel L1. Rukaj Rupalb'al Tijonik. Cuarto Primaria.

6. Comunicación y Lenguaje Kaqchikel L1. Ro' Rupalb'al Tijonik. Quinto Primaria.
7. Comunicación y Lenguaje Kaqchikel L1. Ruwaq Rupalb'al Tijonik. Sexto Primaria.

Modalidad L2

1. Kojtzijon pa Kaqchikel. Comunicación y Lenguaje Kaqchikel. L2. Nab'ey Rupalb'al Tijonik. Primero Primaria.
2. Kojtzijon pa Kaqchikel. Comunicación y Lenguaje Kaqchikel. L2. Ruka'n Rupalb'al Tijonik. Segundo Primaria.

Para los usos legales que a la institución convenga, extendiendo, firmo y sello la presente en una hoja de papel bond, a los cinco días del mes de abril del año 2004.

María del Carmen Tuy Tococho
Presidenta Comunidad Lingüística Kaqchikel



Nab'ey taq tzij



Re sik'iwuj re' kichin tijoxela', ri e k'o pa Rox Rupalb'al Tijonik chuqa' ri ketaman chik yech'o Pa Kaqchikel ch'ab'äl. Jalajöj taq na'oj, taq samaj e k'o chupam. Ri Kaqchikel Moloj nurayb'ej chi ri tijoxela' xtikitajej ta ri nimaläj taq etamab'äl kiya'on kan ri qati't qamama'.

Rik'in k'a re jujun na'oj re' nrayb'ex chuqa' chi ri tijoxela' nkinimirisaj ta ri ketamab'al ke chuqa' ri', xtikinik'oj, xtikinük' rupam re wuj re' richin ke ri' pa rub'eyal ta xketz'ib'an ri chuwa'q kab'ij apo.

Ri na'oj xke'ilitäj chupam re sik'iwuj re', e nuk'un richin jeb'ël ta xketz'ib'an chuqa' xtikinük' nimaläj taq na'oj. Ronojel ri tanaj numol ruchi' ri na'oj ketaman chik pe rije' pa ruwi' kik'aslem; chuqa' nuya' rejqalem ri kipixa' ketamab'al ri qati't qamama' pa ruwi' ri utziläj taq na'oj, utziläj k'aslemal.

Ri tijoxel xtitz'ib'an xtich'ob'on pa ruwi' re ka'i' oxi' na'oj re':

a) Rejqalem ri rutinamit, ä) Rejqalem ri samaj. b')Rokisaxik pa rub'eyal ri Kaqchikel ch'ab'äl, ch) Rejqalem ri ach'alalri'il, ch') Ri rutzijol nuya' ri kajulew, e) Rutz'ib'axik ri rub'anikil rub'anob'al ri qatinamit, ë) Rejqalem ri qati't ik' qatata' q'ij, i) Ruxe'el ri cholq'ij i) Maya' Ajilab'äl, juk'al k'a B'elejlajk'al b'elejlajuj.

Rub'eyal Rokisaxik re Wuj re'



Re wuj re' e k'o b'eleje' tanaj chupam, ri jujun tanaj e k'o jalajöj na'oj chuqa' rub'eyal richin nkisamajij ri tijoxela'.

Ri jujun tanaj rujachon ri' pa oxi' nimaläj taq rub'eyal:

a) Ri wetaman ä) Ri ninwetamaj b') Ri xinwetamaj.

Chupam ri jujun nimaläj taq rub'eyal, e k'o na'oj chuqa' samaj akuchi ri tijoxela': yetzijon, nkiya' retal kik'aslem, nkiya' retal kina'ojib'al, nkiya' ketamab'al, yesamäj kik'in kachib'il, yesamäj rik'in ri tijonel, yesamäj pa kochoch, yekipeyoj winaqi' richin nkijunamaj ri kina'oj, yekib'än achib'äl, yeb'ixan chuqa' ch'aqa chik.

Pa ruwi' ronojel re samaj xeqatzijoj, k'o ka'i' na'oj ri man kemestäx, chi ri tijoxela' k'o chi yetz'ib'an chuqa' k'o chi yekinuk' kina'oj, pa ruwi' ri tzijonem richin ri tanaj akuchi e k'o wi.

Nk'atzin nketamaj nkib'än kisamaj pa ch'ajch'öj, ütz nkina'ojij samaj pa taq kochoch chuqa' kan pa rucholajen nkib'än pe chi re, richin ke ri' nkitz'ajb'a' chuwäch xan pa tijob'äl, richin man nkimestaj ta ri samaj yekib'än.

Nqanataj chi junam kejqalem ri ak'wala', chi ixtani' chi alab'oni' töq yesamaj. Ronojel ri wachinäq e k'o pa qatinamit ütz yeqokisaj, richin ke ri' k'i'y rub'eyal rusamajixik ri tijonik nqab'än chi re.

Pa ruk'isib'äl nqanataj chi ri ak'wala' yekikot, we rat ak'wan kikotem, ruma ri', k'atzinel chi yojb'ixan, yojetz'an, yeqanuk' jalajöj taq achib'äl. Yalan ta jeb'ël xtub'än.

NAB'EY TANAJ

RI NUTINAMIT

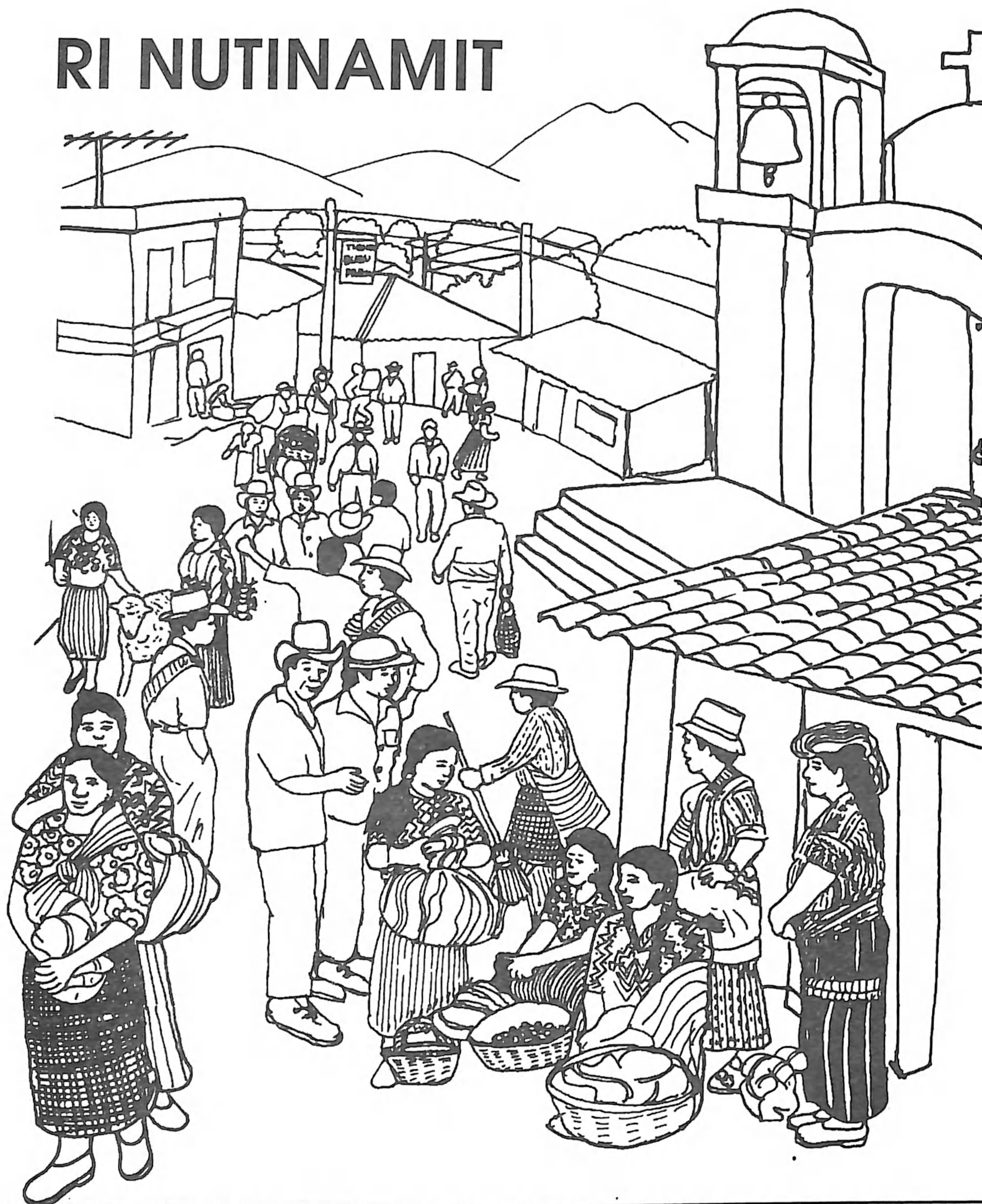

Ri tijoxel etamanik nuq'i' ri tijoxel:
Nutz'ib'aj jalajöj taq na'oj pa ruwi' ri rutinamit.
Nuch'ob' jalajöj taq na'oj pa ruwi' rutinamit.
Nretamaj kib'i' ch' aqa chik tinamit.





Tqatz'ib'aj ri na'oj xqetamaj pa ruwi' ri achib'äl

- 1 _____
- 2 _____
- 3 _____
- 4 _____
- 5 _____



.. Ri tijonel nub'ixaj jun ti b'ix rub'ini'an Nutinamit
... Ri tijonel, yerunuk' pa ox'ox ri tijoxela k'a ri yetzijon chi rij ri kitinamit
... Ri tijoxela' yetzijon, k'a ri nkitz'ib'aj wo'o' taq b'ab pa ruwi' ri xkitz'ijoj
.... Pa ruk'isib'äl ri tijoxela' nkisik'ij ri xkitz'ib'aj.



Kejqalem ri nima'q taq winaqi' e k'o pa qatinamit

Pa jun tinamit e k'o jalajöj taq winaqi', e k'o ri k'amöl taq b'ey, e k'o ri chinamital, ri k'utunela', ri k'ulunela', ri kexelon, ri e yuqüy taq b'aaq. Re jujun winaqi' re', yalan nüm kejqalem ruma yekito' ri winaqi'. Re samaj kichajin re winaqi' re', kan kik'amon pe pa kalaxik. Ruma ri' yalan nüm kejqalem pa qatinamit.



Tqatz'ib'aj achike kiwäch winaqi' e k'o pa qatinamit.

Blank writing area with horizontal lines and a pencil icon in the top right corner.

- . Ri tijonel nusol chi kiwäch ri tijoxela' kejqalem ri winaqi' pa qatinamit.
- .. Ri tijoxela' nkitz'ib'aj jalajöj taq na'oj pa ruwi' ri winaqi' e k'o pa qatinamit.
- ... Ri tijoxela' nkiya' kib'i' ri achib'äl xekib'än.
- Ri tijonel numol ri achib'äl xekib'än ri tijoxela', yerutz'arab'a' chuwäch ri xan.



Tqatz'ib'aj kib'i' re jujun achib'äl.

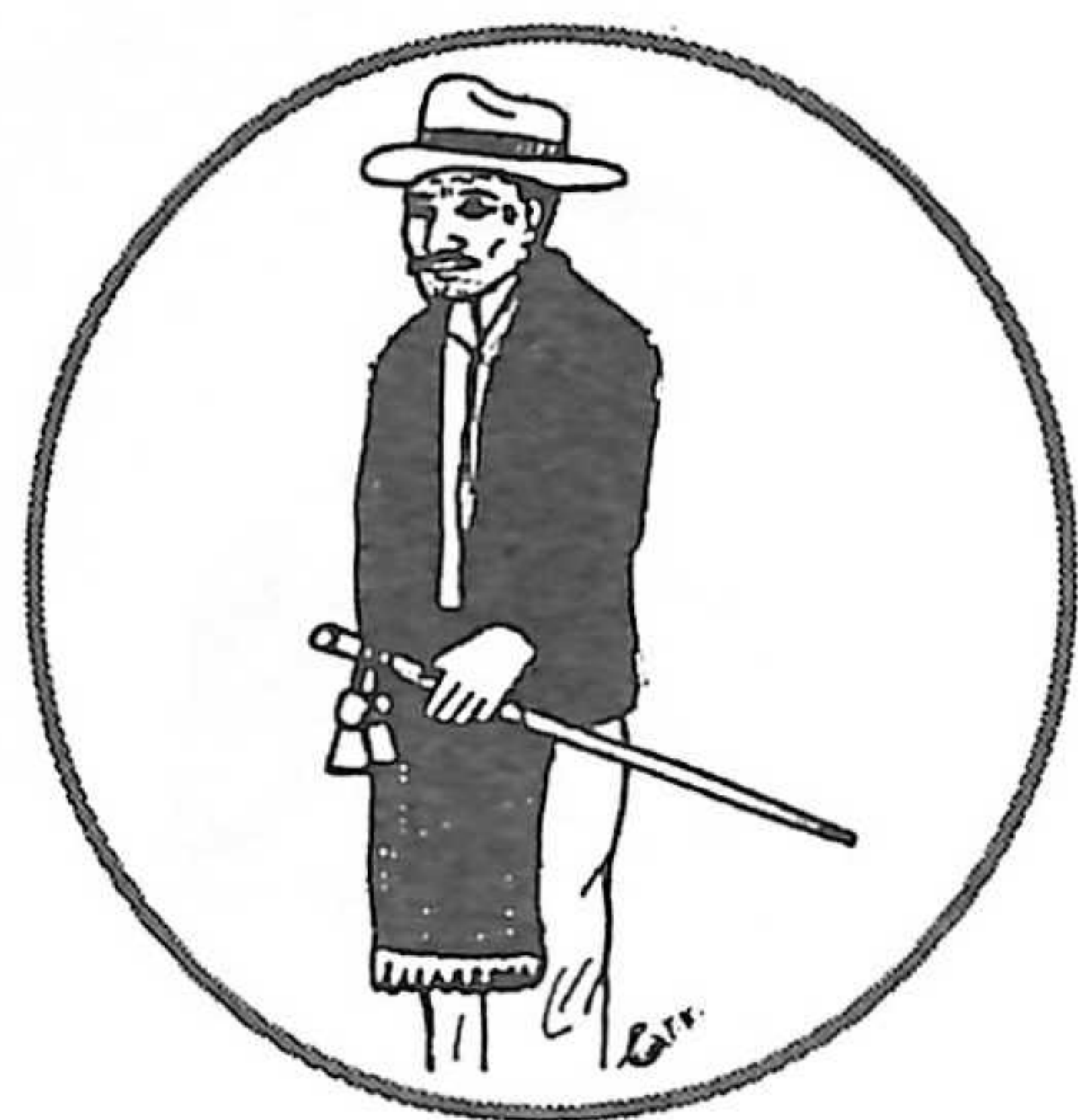
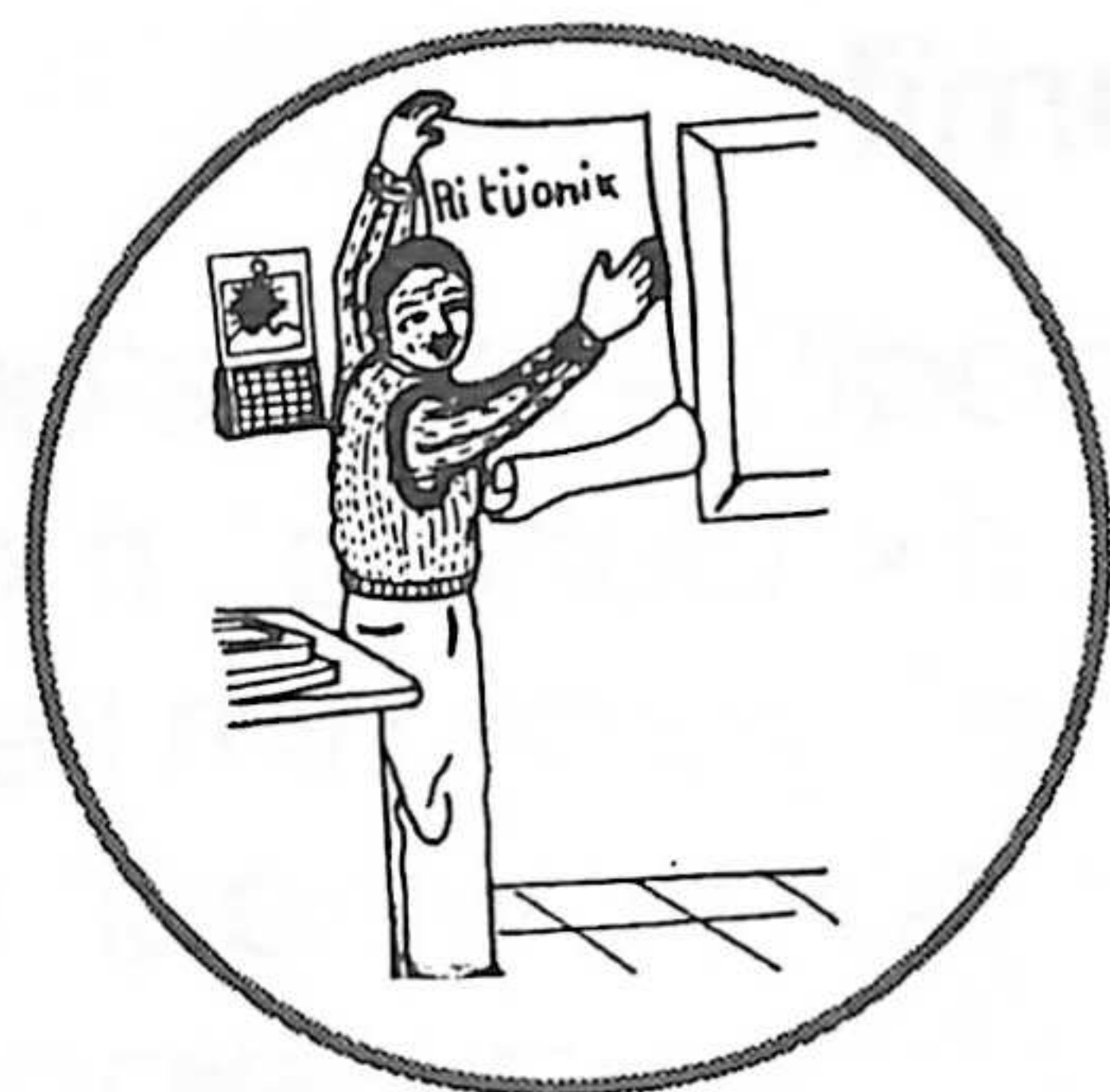

1. Tqatz'ib'aj rejqalem ri qatinamit töq e k'o utziläj taq winaqi' chupam.

Handwriting practice area with horizontal lines and a pencil illustration.

- .. Ri t'ijonel yeruto' ri t'ijoxela' richln nkiya' kib'i' ri achib'äl.
- .. Ri t'ijoxela' nkitz'ib'aj kib'i' ri winaqi' e k'o pa achib'äl.



Ri tiko'n nuya' ri qatinamit

Tqatz'ib'aj achike ruwäch
taq tiko'n nuya' pa qatinamit.
Tikirel chuqa' nqatz'ib'aj ri
kiwäch taq che'.

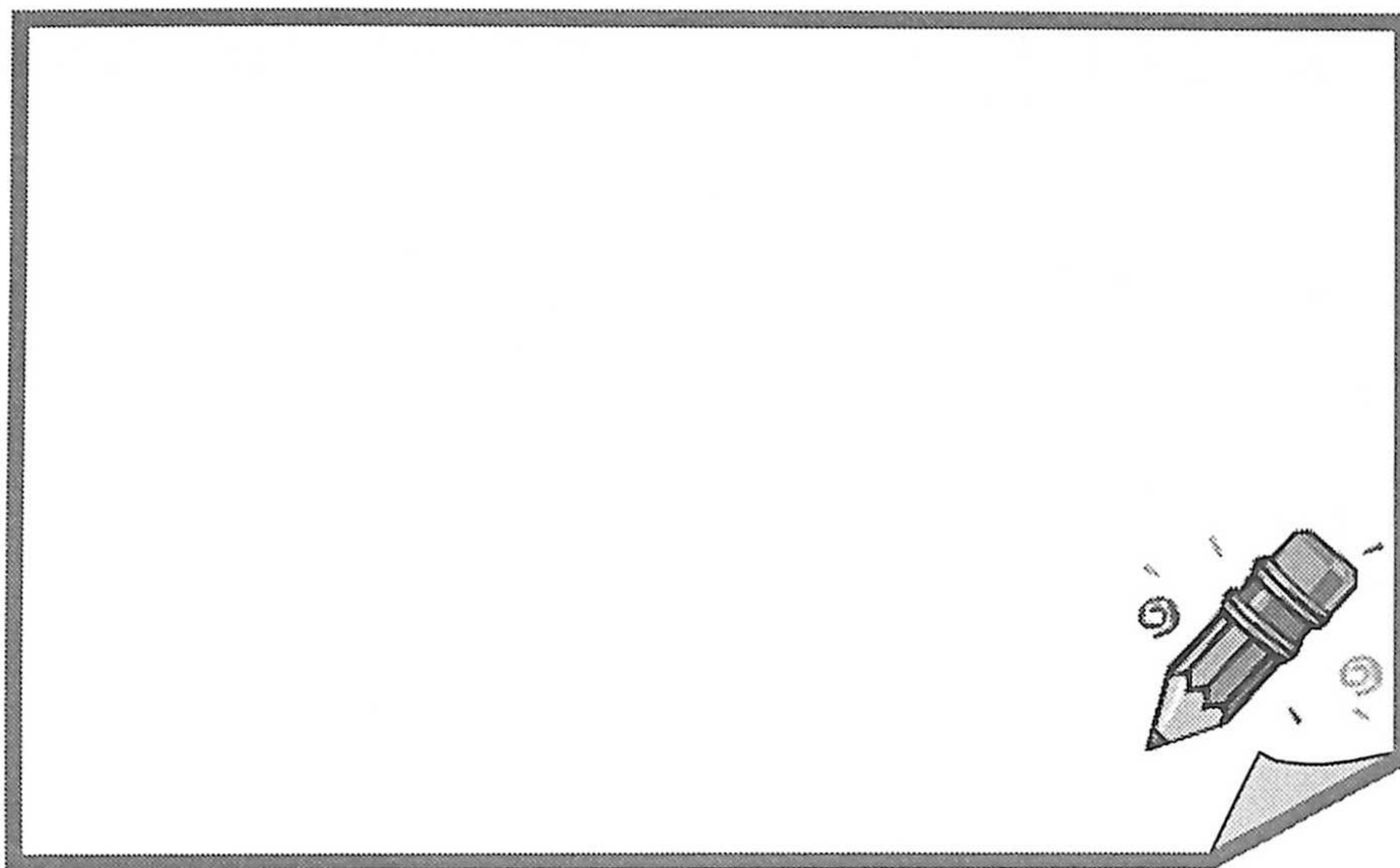

Tqab'ana' kachib'äl ri tiko'n nuya' pa qatinamit.

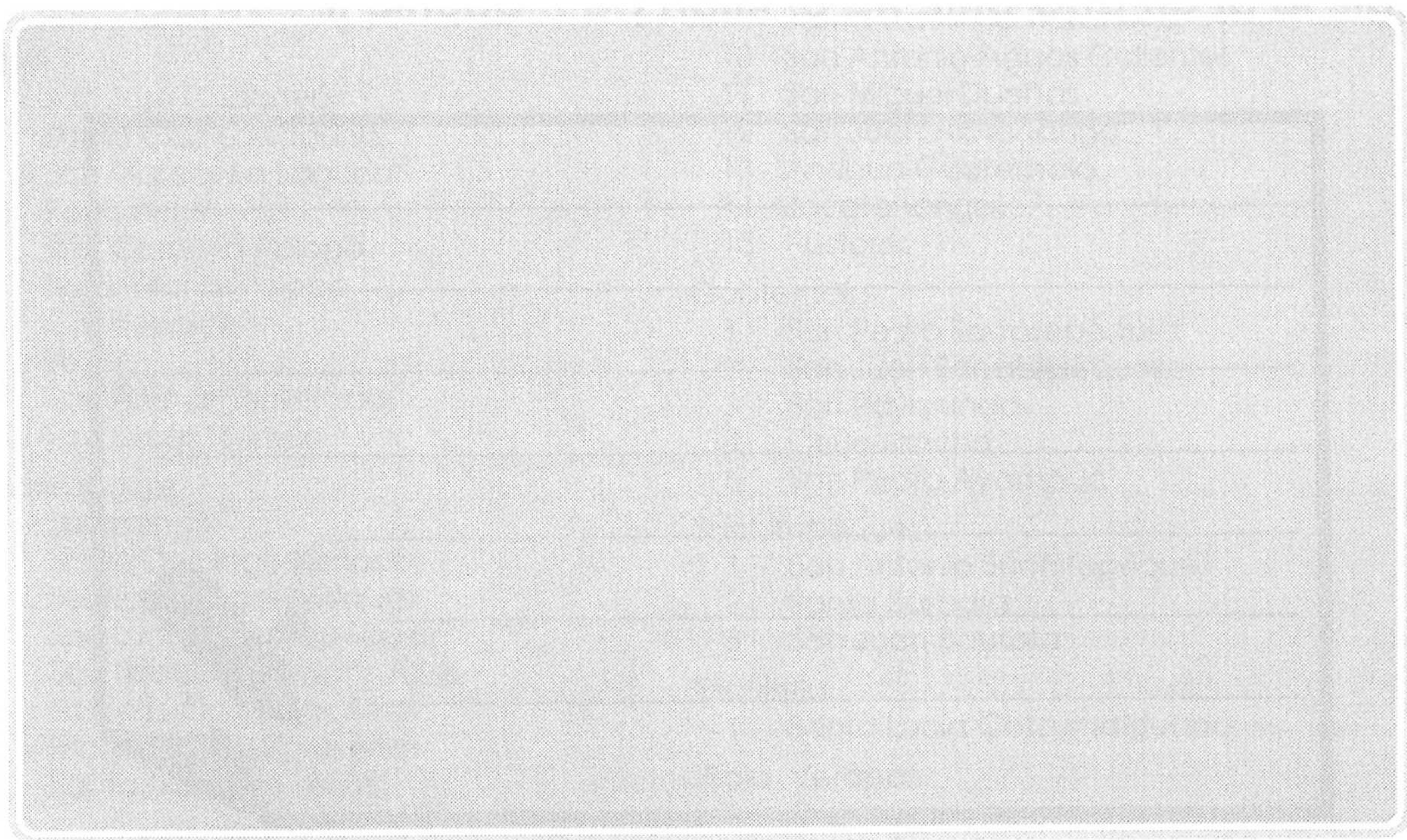

- Ri tijonel k'o chi nab'ey ntzizon pa ruwi' rejqalem ri tiko'n.
- .. Ri tijoxela' yetz'ib'an pa Kitz'ib'awuj.
- ... Ri tijoxela' k'o chi yerub'onij ri achib'äl xkerub'än.

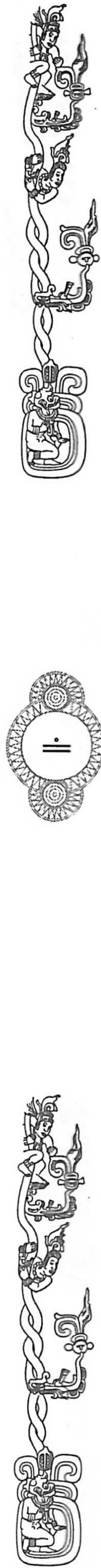

Rub'eyal yojto'on pa qatinamit

Tqak'utuj chi ke ri qate' qatata' chuqa' chi ke qach'alal achike ta rub'eyal yojto'on pa ruwi' qatinamit. Ri na'oj nqil, nqatz'ib'aj chi kiwäch re jujun taq pop.

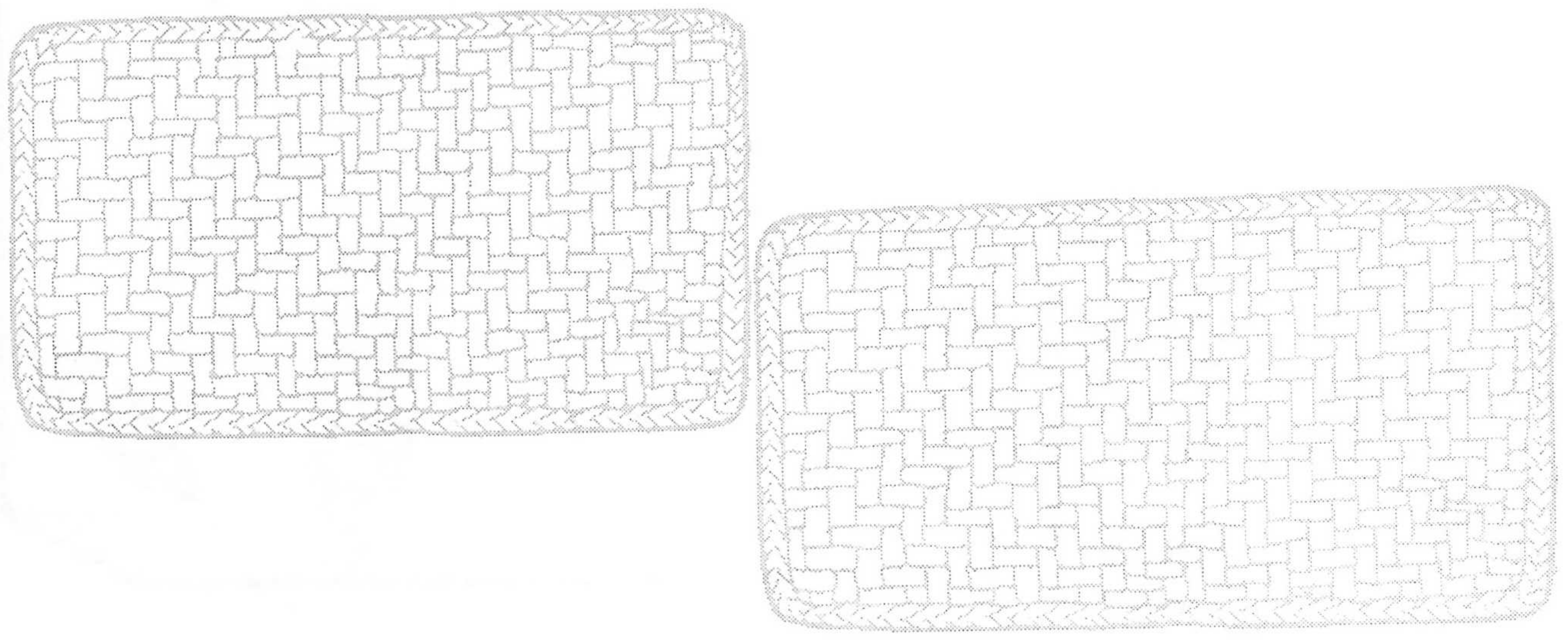
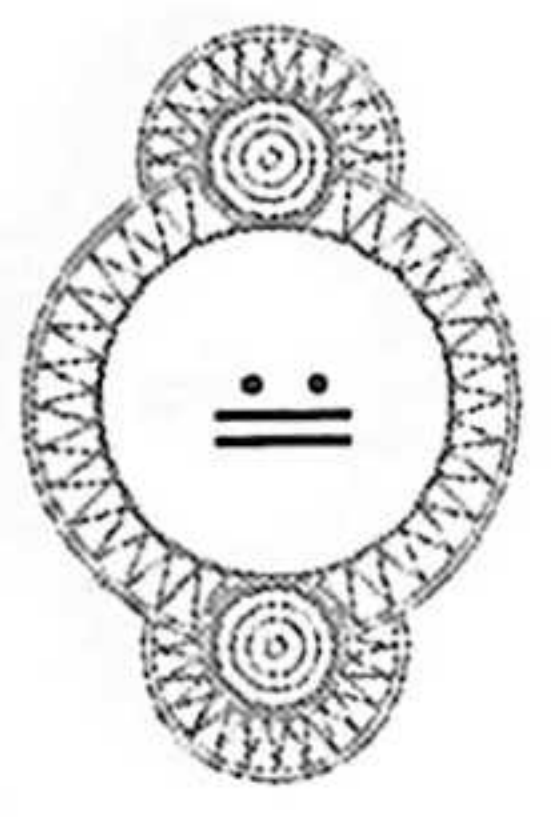
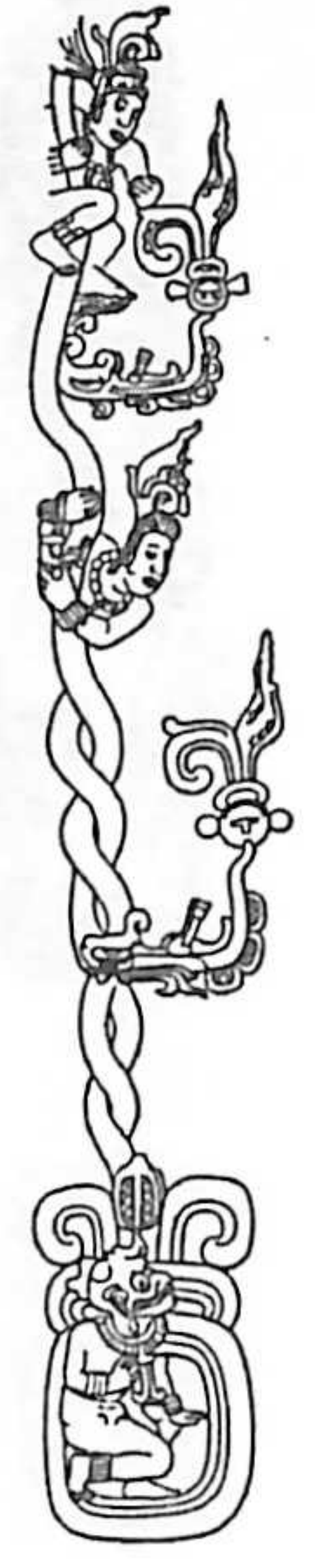

Tqatz'ib'aj ch'aqa chik na'oj kilon pe ri qachib'il



• Ri tijonel k'o chi nab'ey nuk'utuj el chl ke ri tijoxela' re jujun k'utunik re'.
• Ri tijonel tikirel numöl ruchi' ri na'oj k'a ri' ri tijoxela' nkitzi'b'aj chuwäch ri kitz'ib'awuj.

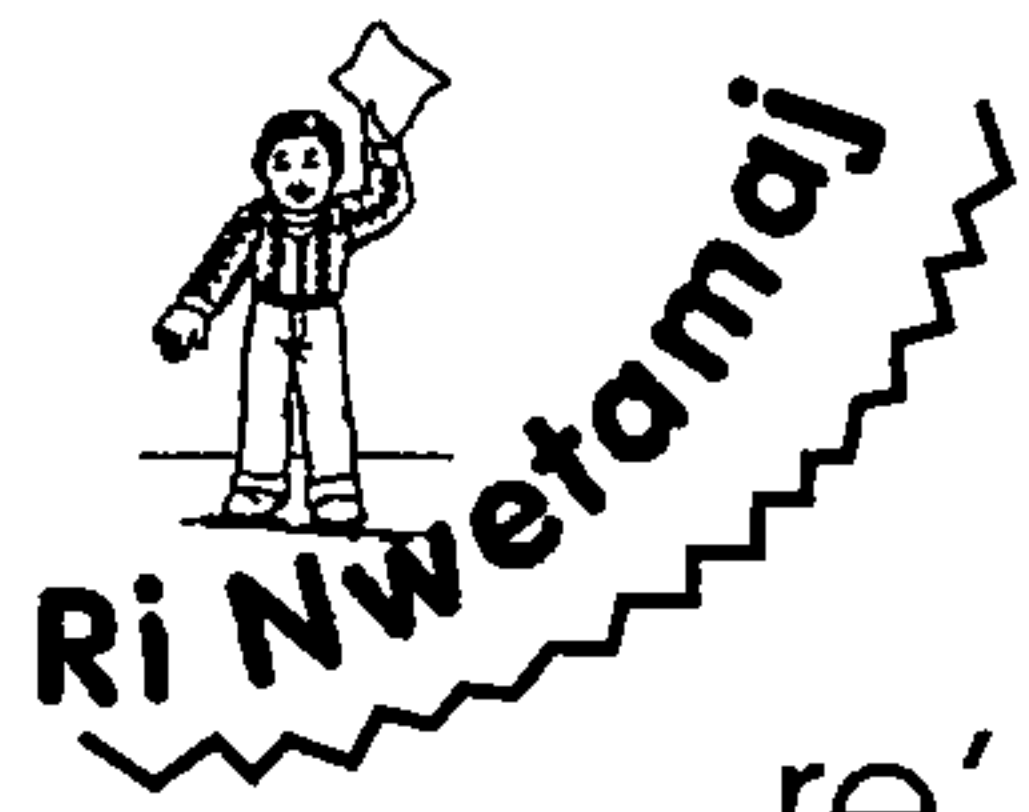

Ri tinamit e k'o pa Kaqulew

Ri kaqulew, ja ri' ri qalewal röj kaqchikela', e ja re' ri tinamital ye'ok chupam: Armita, B'oko', Tz'oloj Ya', Pan Q'an, Chi B'ay, Baja Verapaz, chuqa' Chi Kej, Pa kaqulew e k'o e kak'al waqxaqi' tinamit . Pa kaqulew k'o wi ri Kaqchikel Cholchi' jun chi ke ri ruq'a' ri K'ulb'il Yol Twitz Paxil. (ALMG)

Chimaltenango

- 1 Santa Apolonia
- 2 San Juan Comalapa
- 3 Zaragoza
- 4 San José Poaquil
- 5 Tecpán
- 6 Patzicía
- 7 Patzún
- 8 Santa Cruz Balanyá
- 9 San Martín Jilotepeque
- 10 Chimaltenango
- 11 El Tejar
- 12 Parramos
- 13 San Andrés Itzapa
- 14 Acatenango
- 15 San Pedro Yepocapa
- 16 San Miguel Pochuta

Sololá

- 1 San José Chacayá
- 2 Santa Cruz La Laguna
- 3 San Marcos La Laguna
- 4 Panajachel
- 5 Sta. Catarina Palopó
- 6 San Antonio Palopó
- 7 Concepción
- 8 Sololá
- 9 San Andrés Semetabaj
- 10 San Lucas Tolimán

Sacatepéquez

- 1 Sumpango
- 2 Santo Domingo Xenacoj
- 3 Santiago Sacatepéquez
- 4 San Lucas Sacatepéquez
- 5 San Bartolomé Milpas Altas
- 6 Santa Lucía Milpas Altas
- 7 Magdalena Milpas Altas
- 8 Santa María de Jesús

- 9 Santa Catarina Barahona
- 10 San Antonio Aguas Calientes
- 11 San Miguel Dueñas
- 12 San Juan Alotenango
- 13 Antigua Guatemala
- 14 Jocotenango
- 15 Pastores

Guatemala

- 1 San Pedro Sacatepéquez
- 2 San Juan Sacatepéquez
- 3 San Raymundo
- 4 Chuarrancho
- 5 San Pedro Ayampuc

Suchitepéquez

- 1 San Antonio Suchitepéquez
- 2 Santa Bárbara
- 3 San Juan Bautista

Escuintla

- 1 Santa Lucía Cotzumalguapa

Baja Verapaz

- 1 Granados

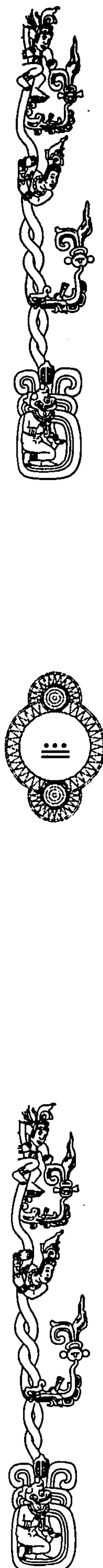
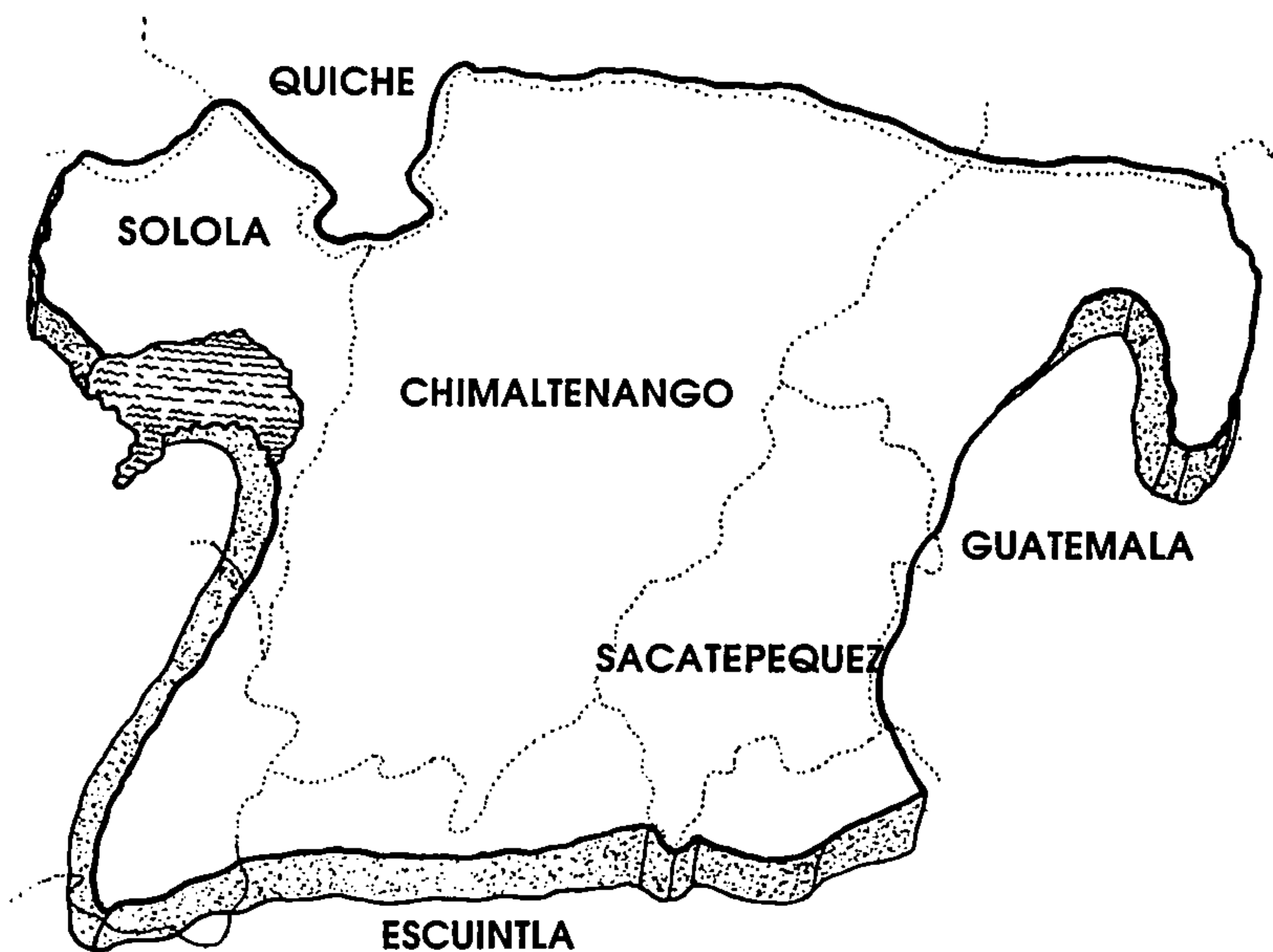

. Ri tijonel nutz'ijoj chi kiwäch ri tijoxela', achike ri kaqulew.
 .. Ri tijoxela' nkikanoj achike rutz'ib'axik pa qach'ab'al ri jujun tinamit. Ri tijonel tikirel yeruto' ri tijoxela' richin nkib'an ri samaj. Re samaj re' nkitz'ib'aj pa kisik'iwuj.
 ... Ri tijoxela' nkib'onij ri tinamital akuchi e k'o wl.

Rusolik kib'i' chuqa'

kib'anob'al ri qatinamit.

Konojel ri tinamit e k'o pa kaqulew k'o jun kixe'el k'o jun kib'anob'al, xa ruma k'a ri' k'o kib'i'. E k'o re', ye'ilitäj chuchi' choy, pa jotöl, pa li'an, chuchi' jun juyu', chuchi' raqän ya'.

Tqetamaj achike rub'anikil
ri jun ojer tinamit Mixku' Ab'äj rub'i'.

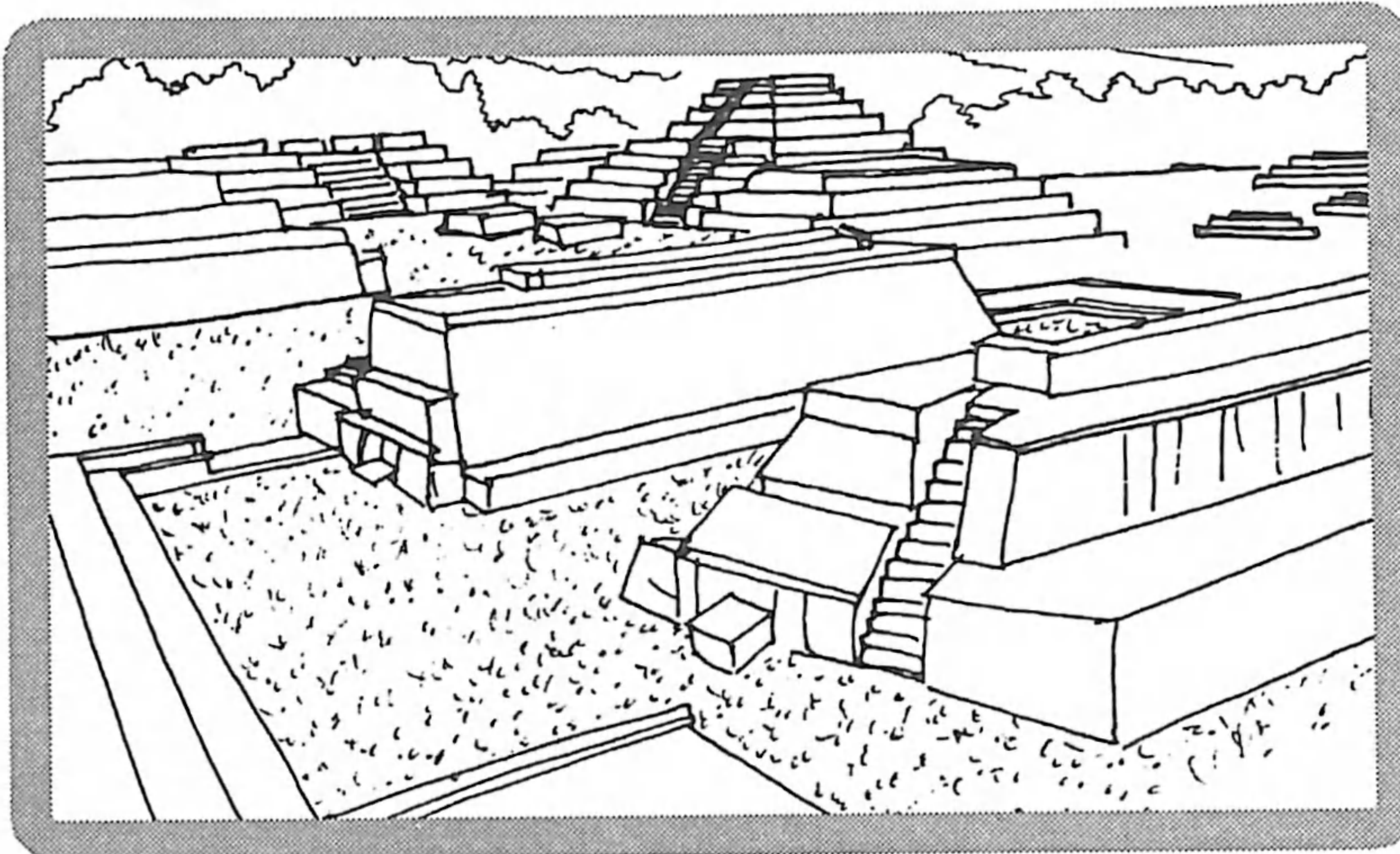

Tqatzib'aj jun ka'i' na'oj
pa ruwi' ri Mixco Viejo.



¿Achike nuq'ajuj ri rub'i' ri atinamit? We man kan ta awetaman
k'o chi nak'utuj chi ke ri ate' atata', k'a ri' tatz'ib'aj'



• Ri tijonel k'o chi nub'lj achike ruma Mixku' Ab'äj rub'i' re jun tinamit re'.
• Ri tijoxela' tikirel nkib'onij ri achib'äl.



Retamaxik kib'i' ch'aaq chik tinamit

1. Tqakanoj kib'i' ri tinamit, e k'o pa qatinamital. Töq xkeqil, keqatz'ib'aj kib'i' pa kiwi' re jujun taq juch'.

2. Tqatzib'aj achike ta rub'eyal richin man nsach kib'i' ri jujun tinamit pa qach'ab'äl.





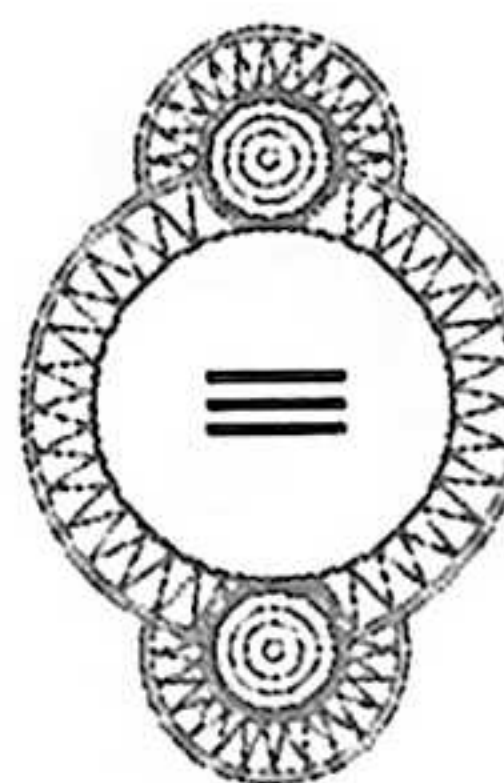

.. La pa nab'ey samaj ri tijonel k'o chi nuk'utuj el chi ke ri tijoxela', richin nkikanoj pe.
 .. We yalan k'ayew rilixik ri na'oj tikirel nya'ox el chuwäch wuj.



Ruchajixik ri ruk'ojlem ri qatinamit



1. Tqatz'ib'aj wo'o' na'oj richin ruchajixik ri qatinamit.

A large rectangular box with a light gray background and horizontal lines for writing. In the bottom right corner, there is a small illustration of a pencil.



2. Tqanuk'u' jun ti b'ix rik'in ri na'oj xqatz'ib'aj kan.

A rectangular box with a light gray background and horizontal lines for writing. In the center, there is a large, faint watermark of a musical staff with notes. In the bottom right corner, there is a small illustration of a pencil.



Pa nab'ey solojsamaj ri tijonel k'o chi yeruto' ri tijoxela' richin nkitz'ib'aj ri kina'oj.
 Ri tijonel k'o chi nutijoj ri' achike rub'eyal nnuk' jun ti b'ix.



Retamaxik ri na'oj xsöl chupam re nab'ey tanaj re'

Pa jujun taq achib'äl tqatz'ib'aj ri nk'utux chi qe.

Tqatz'ib'aj achike ri',
ri jun tinamit

Tqatz'ib'aj rub'i' ri
qatinamit pa qach'ab'äl

Tqatz'ib'aj kib'i' wo'o'
tinamit pa qach'ab'äl

Ri tjonel nuya' rub'ixik, achike rub'eyal re jun tojtob'enik re'.



B'ix Röj winaqi'

Röj winaqi'
nk'atzin ri qochoch
röj winaqi'
nk'atzin ri qaway.

Kixampe wach'alal
kixampe ixoqi'
kixampe tata'aj
kixampe iwonojel.

Man katzu'un chi kaj
man katzu'un pa ulew
tatzu' re ruwach'ulew
tatzu' re k'ayewal.

Röj winaqi'
nk'atzin ri qaya'
röj winaqi'
nk'atzin ri qatzyaq.

Röj winaqi'
nk'atzin ri qatijob'al
röj winaqi'
nk'atzin ri qasamaj.

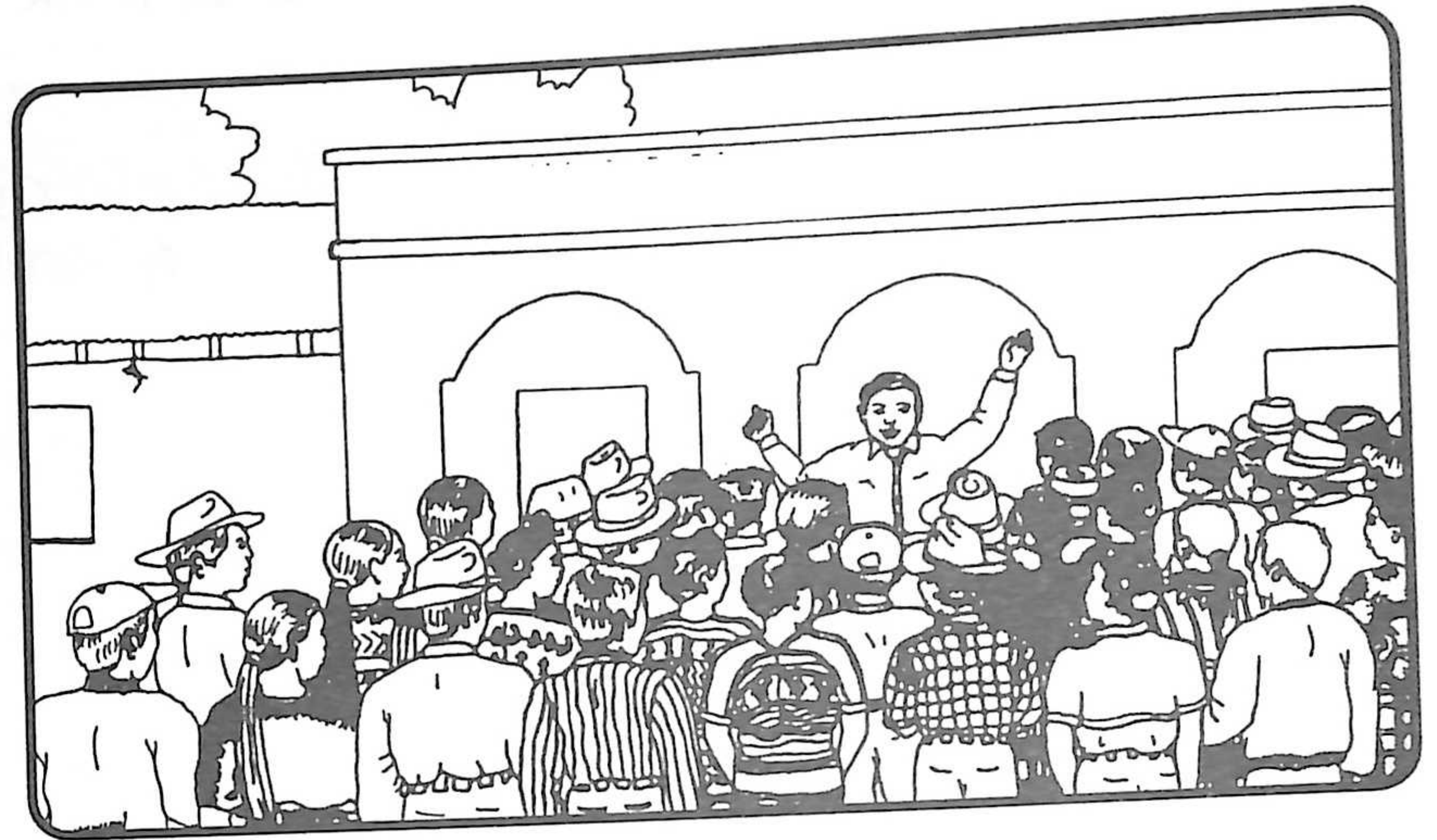

Tzib'anel chuqa' ya'öl ruq'ojom:

Augusto Cujcuj Martínez.

RUKA'N TANAJ

REJQALEM RI SAMAJ PA QAK'ASLEM

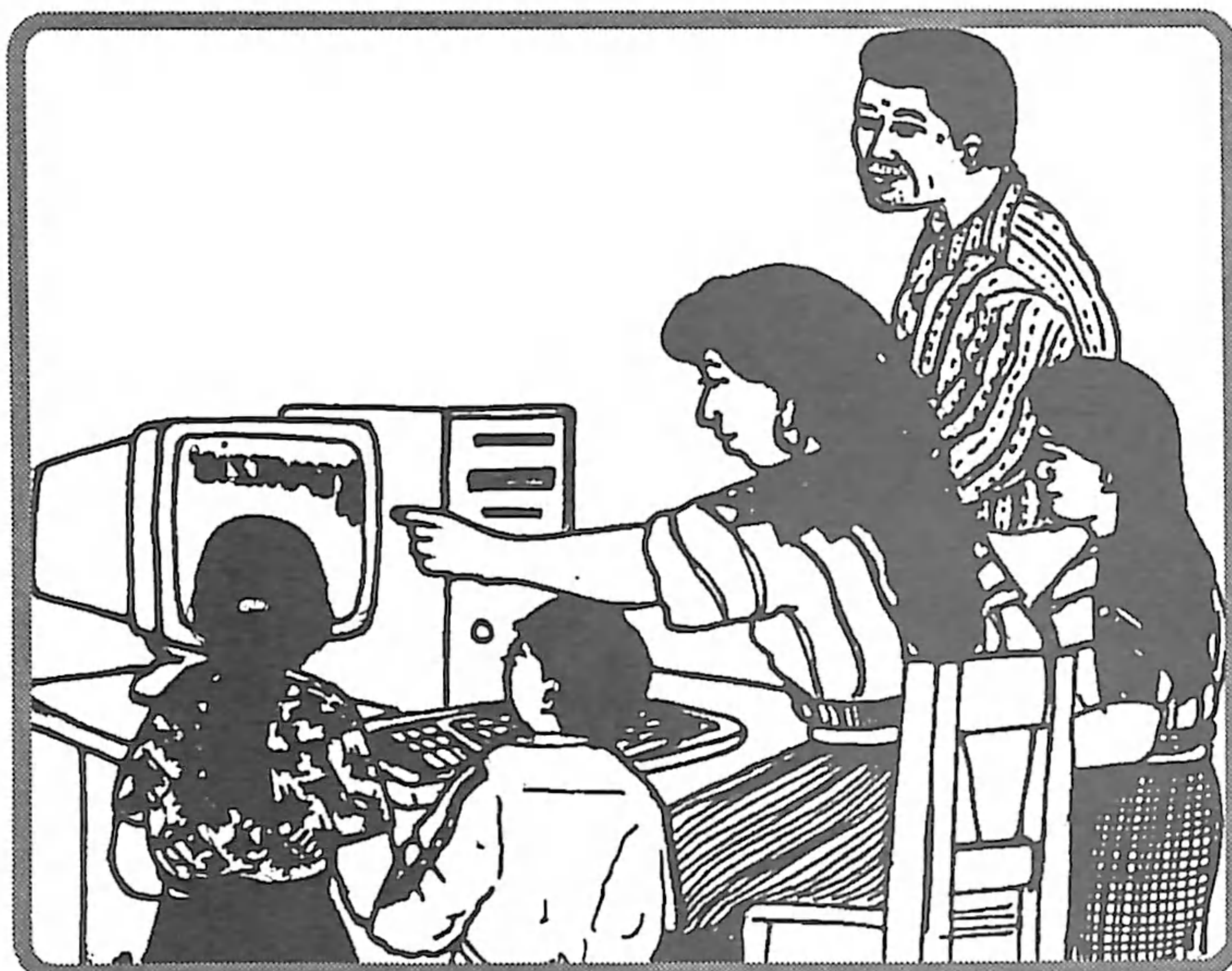
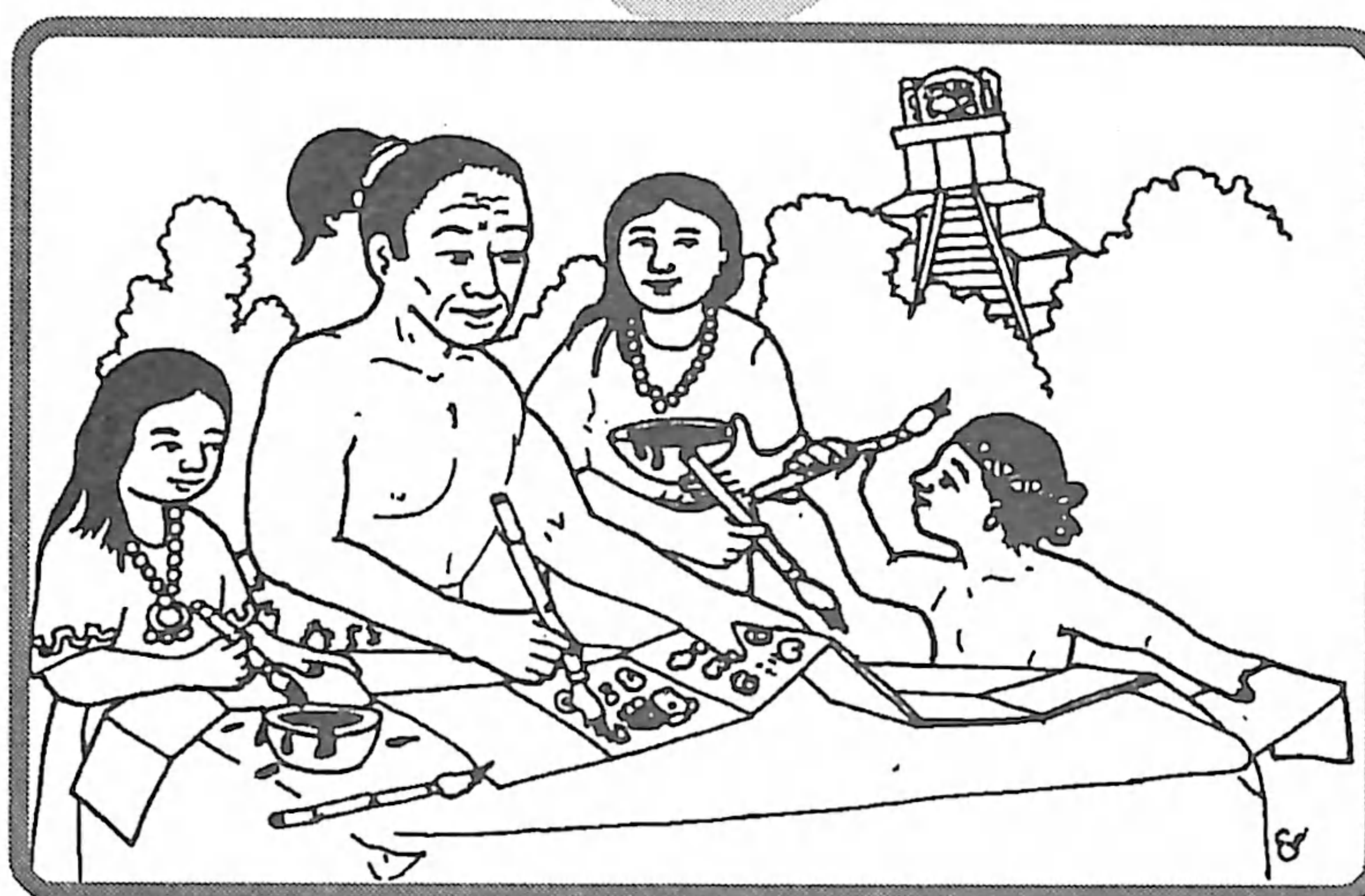

Ri etamanik nuq'i' ri tijoxel:

Ntzijon pa ruwi' ri rejqalem ri samaj.

Nutz'ib'aj jalajöj kiwäch samaj.

Nusik'ij na'oj pa ruwi' rejqalem ri samaj.

Nuk'utuj chi ke rute' rutata' pa ruwi' ri samaj.

Rejqalem ri samaj pa qana'oj

Pa ruk'aslem ri maya' tinamit, ri samaj nim rejqalem. Ri ojer kan, ri qawinaq yalan xkito' ki' pa ruwi' kisamaj, xa xe k'a ke ri', xetikir xekipab'ala' nima'q taq k'oxnun chuqa' nima'q taq na'oj.

1. Tqatz'ib'aj ¿achike ruma k'atzinel ri to'onik pa ruwi' ri samaj?

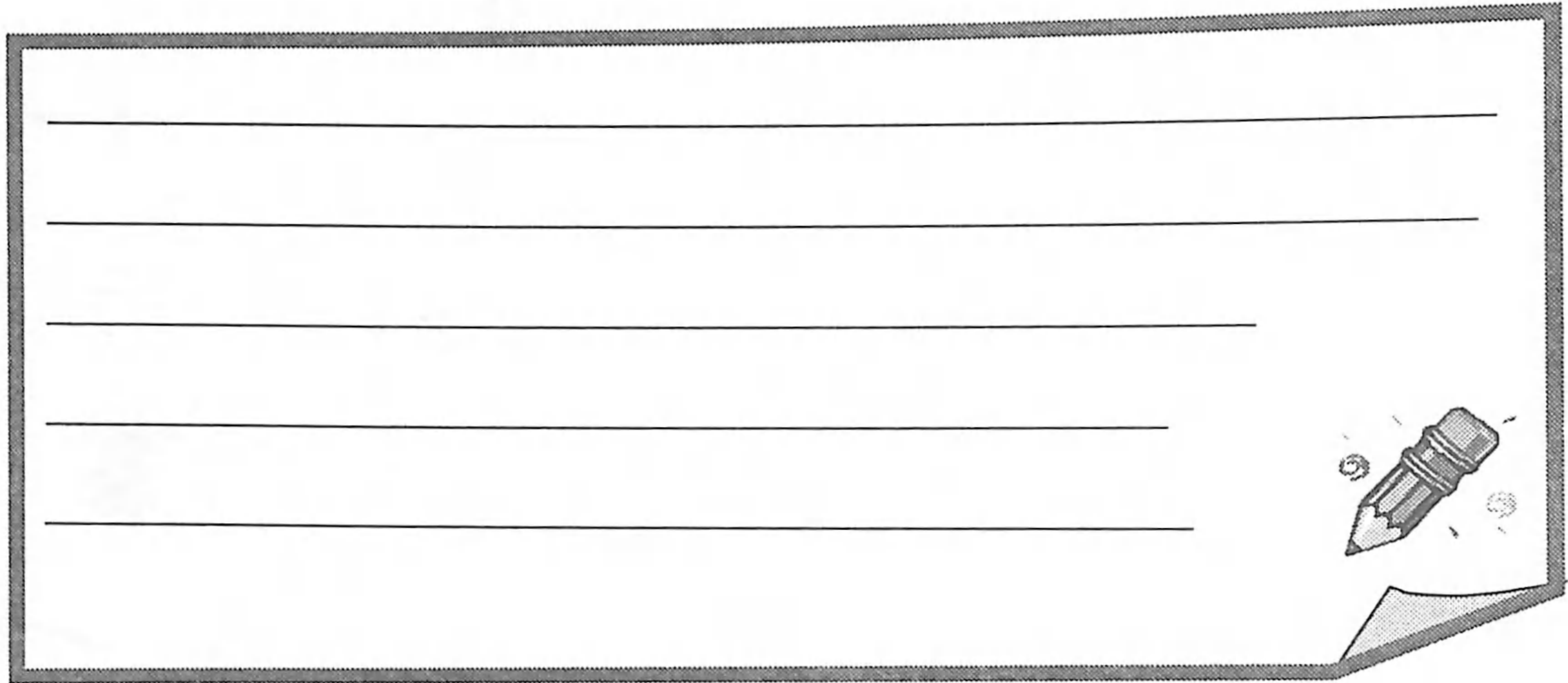

2. Tqak'utuj chi ke ri qate' qatata', achike samaj ketaman rije'. Tqatz'ib'aj pe chupam re jujun taq setesäq.

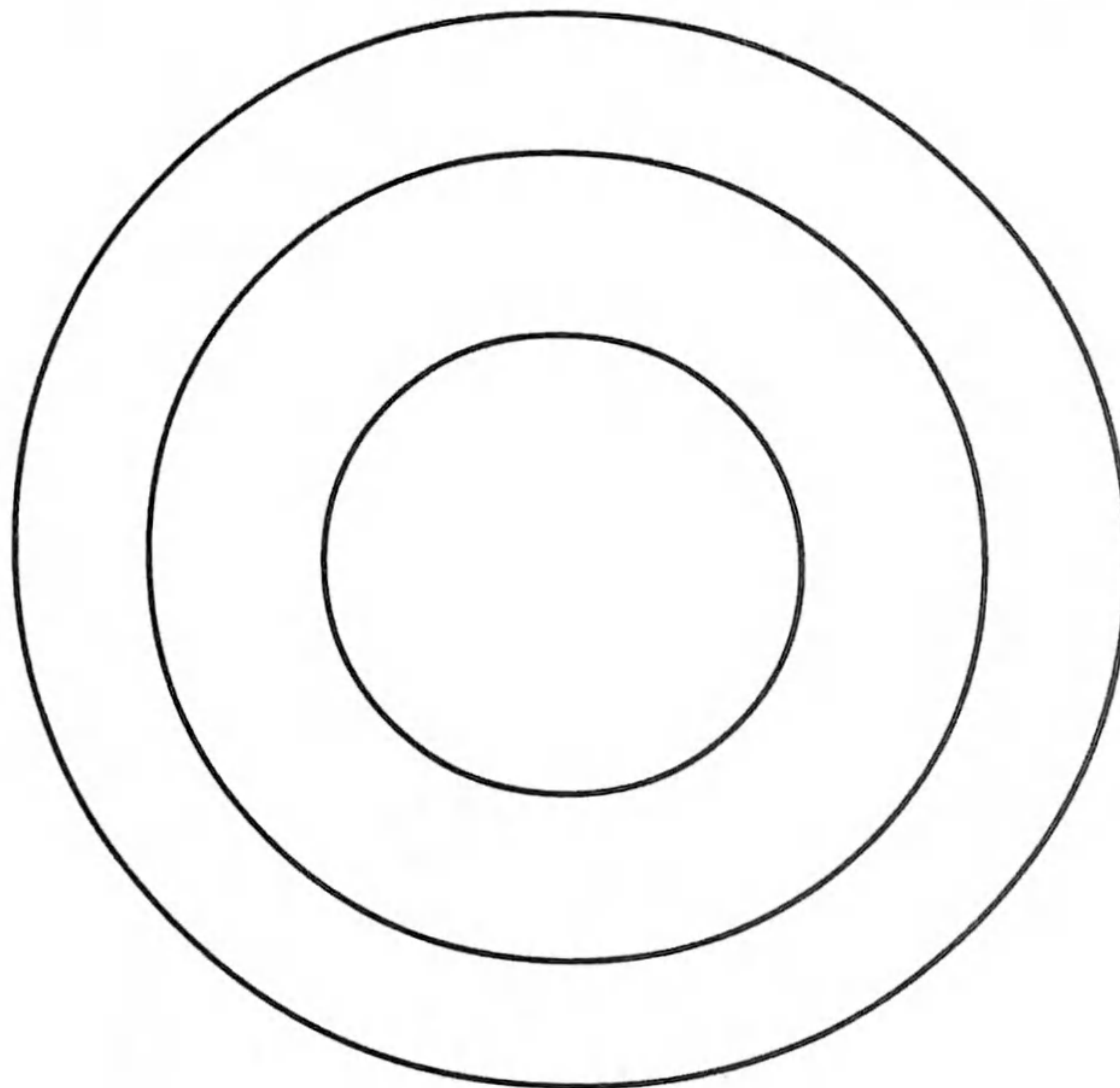

- .. Ri tijonel k'o chi nuk'utuj el chi ke ri tijoxela' chi yetzijon pe kik'in ri kite' kitata' pa ruwi' la jun k'utunik.
- .. Ri tijoxel k'o chi nusik'ij ri jun tzijonem.
- ... Ri tijoxela' yetz'ib'an pa kiwi' la taq juch'.



Ri Samaj k'o pa Qochoch

Tqatz'ib'aj chupam re taq setesäq, achike samaj k'atzinel nb'an pa qochoch.

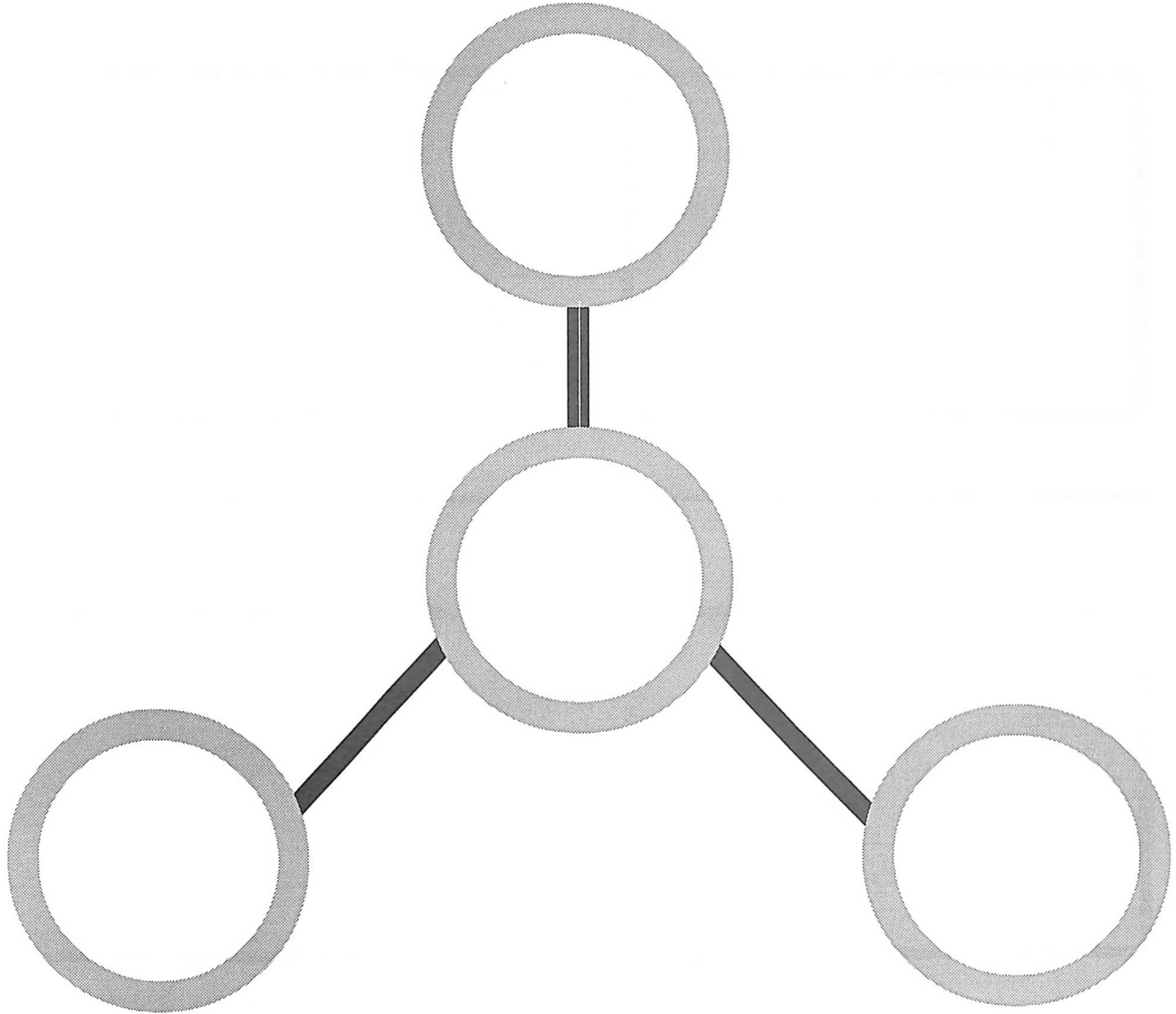

- Ri tijonel k'atzinel nub'an jun etz'anem kik'in ri tijoxela'.
- We k'a k'o na kina'oj ri tijoxela' ütznkitz'ib'aj pa ruwi' la taq juch'.

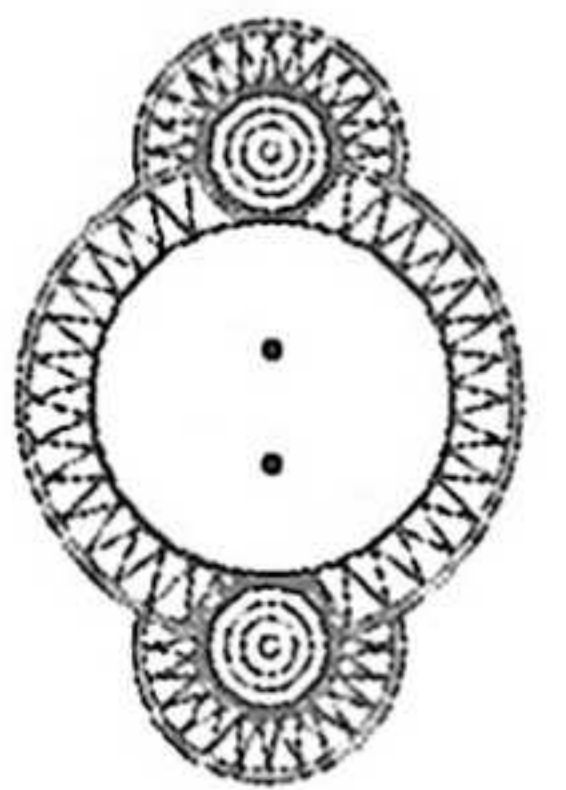

Ri samaj nb'an pa tijob'äl



Ke'aqupij pa taluwuj, ri jalajöj samaj yeb'an pa tijob'äl,
k'a ri' ye'atz'arab'a' chi kipam re faq kajtz'uk

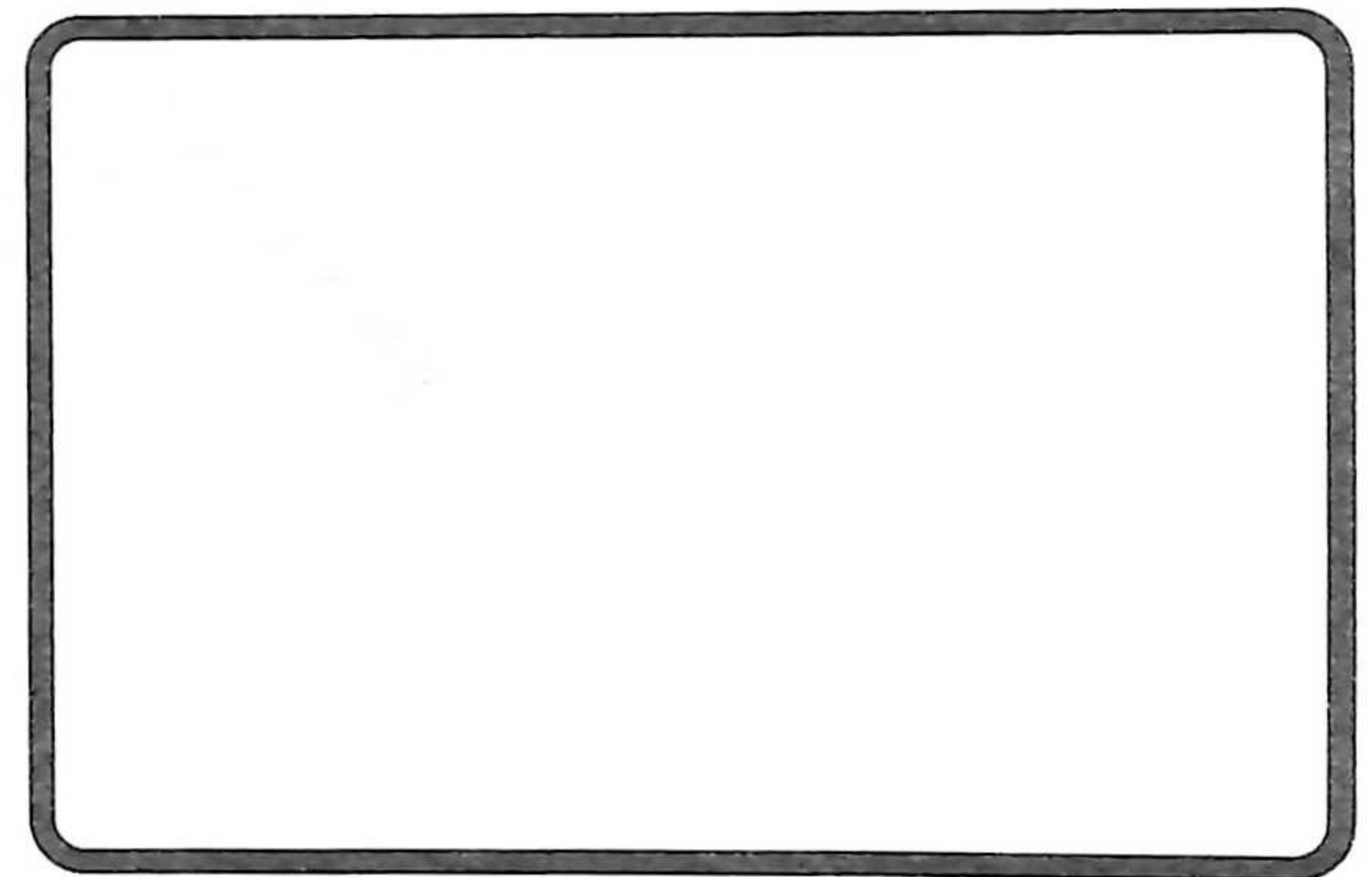
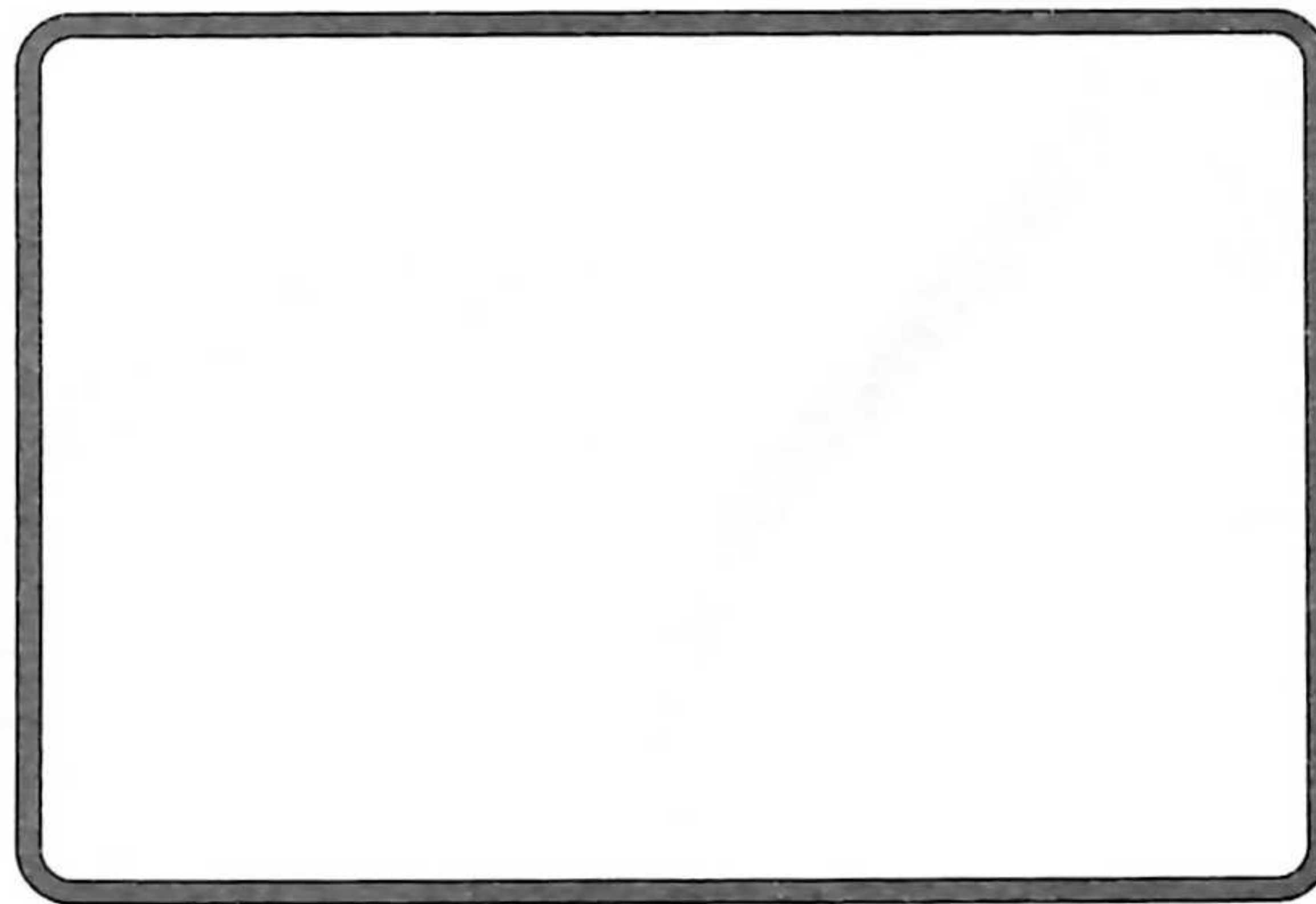
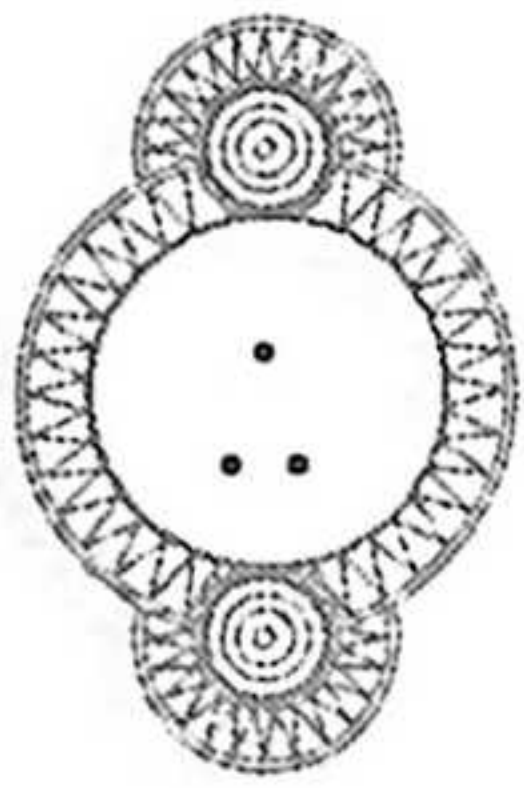
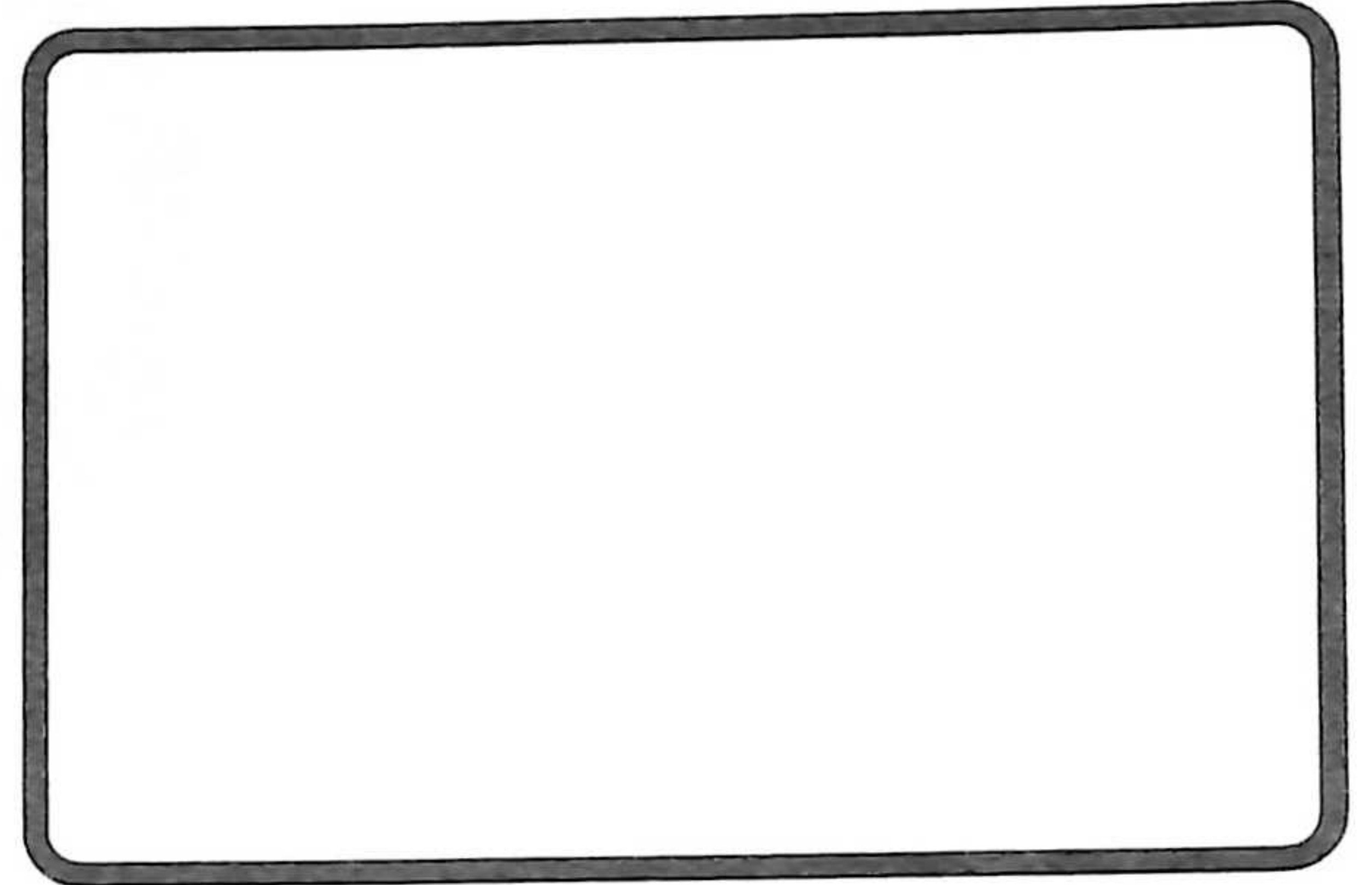
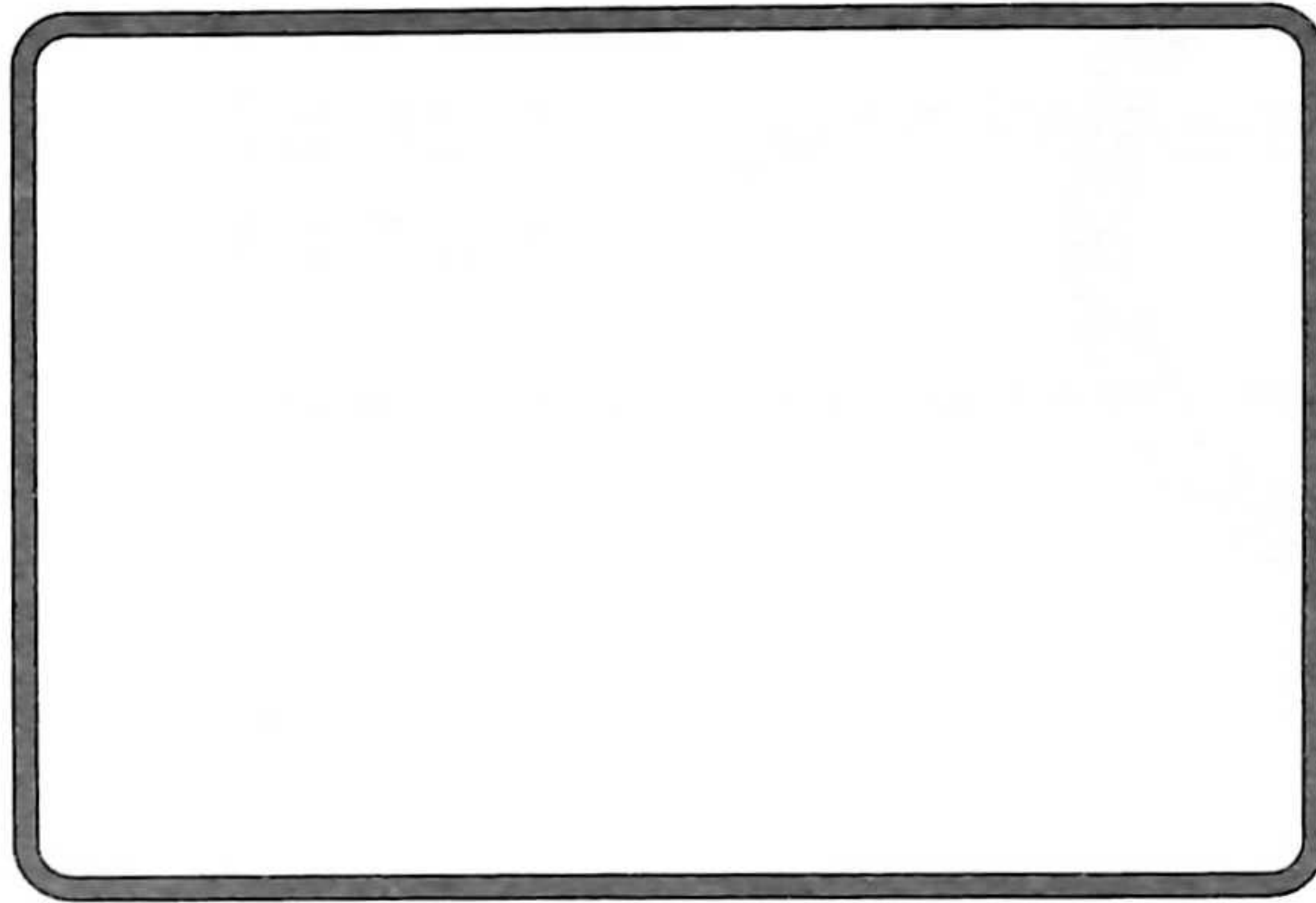

Tqatz'ib'aj pa qatz'ib'awuj ri b'ix Jo' pa tijob'äl.



- . Ri tijonel k'o chi nuk'waj ruxaq taluwuj, richin nkiqupij ri ak'wala'.
- .. Ri tijonel nub'ixaj chi kiwäch ri ak'wala' ri jun ti b'ix rub'ini'an. Jo pa tijob'äl, richin ri FUNKAQ.
- ... Ri tijoxela' nkitz'ib'aj jun b'ix, jun pach'un tzij pa ruwi' ri samaj nb'an pa tijob'äl.



Ri samaj yeb'an pa tijob'äl

Keqakanoj ri nkiq'ajuj re jujun tawila' re'.



Ja ri' samaj nb'an töq ri tijonel nch'o kik'in ri ak'wala', ri ak'wala' yetzijon.
¿ACHIKE RI'?

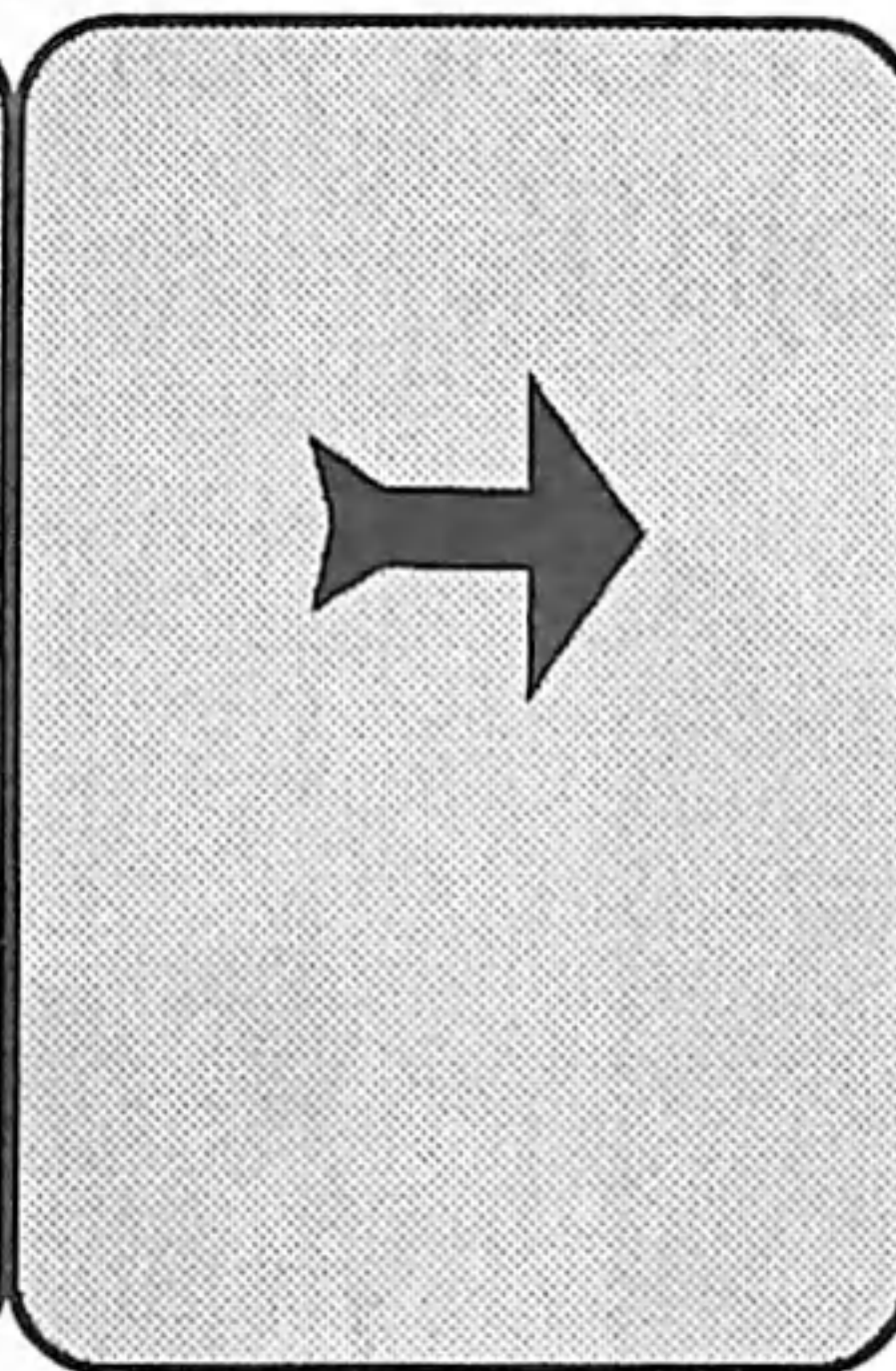

Ja ri' ri samaj nkib'än tijoxela' töq nkichäp jun ti che' watzawik ruwi', konojel nkirayij nkichäp.
¿ACHIKE RI'?

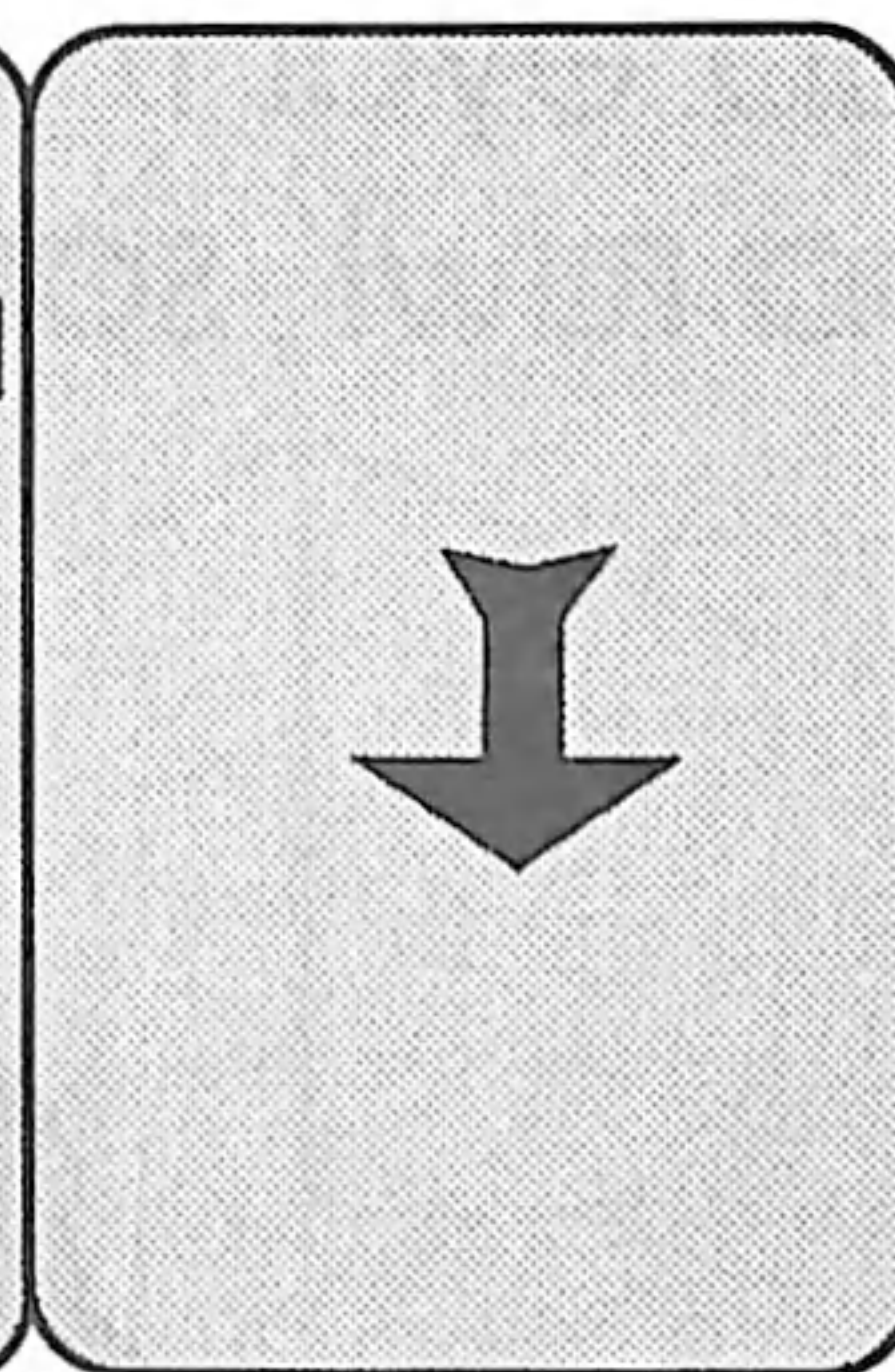

Ja ri' ri b'anob'äl nkib'än ri ak'wala', töq k'o yetz'ijon, yalan tik'asäs nawak'axaj.
¿ACHIKE RI'?



Nim wetamab'al xinwil.

Nkib'obj'a kiq'a' konojel ri tijoxela'

Ja ri' ri b'anob'äl töq ri ak'wala', yeropin, yetzaq, ye'anin.
¿ACHIKE RI'?

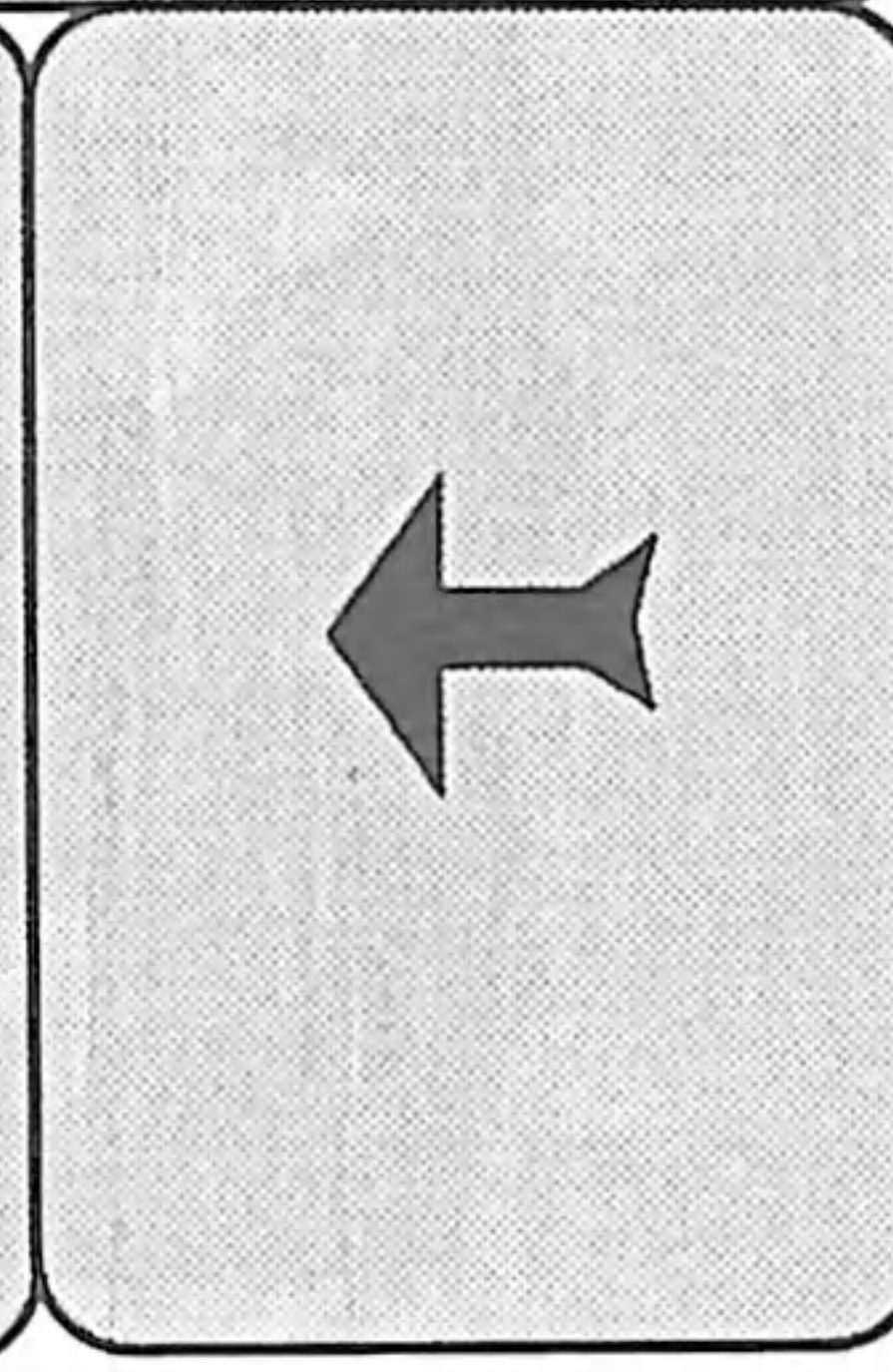

Tqatz'ib'aj wawe' ri kib'i' ri jujun tawila'

Four horizontal lines for writing.

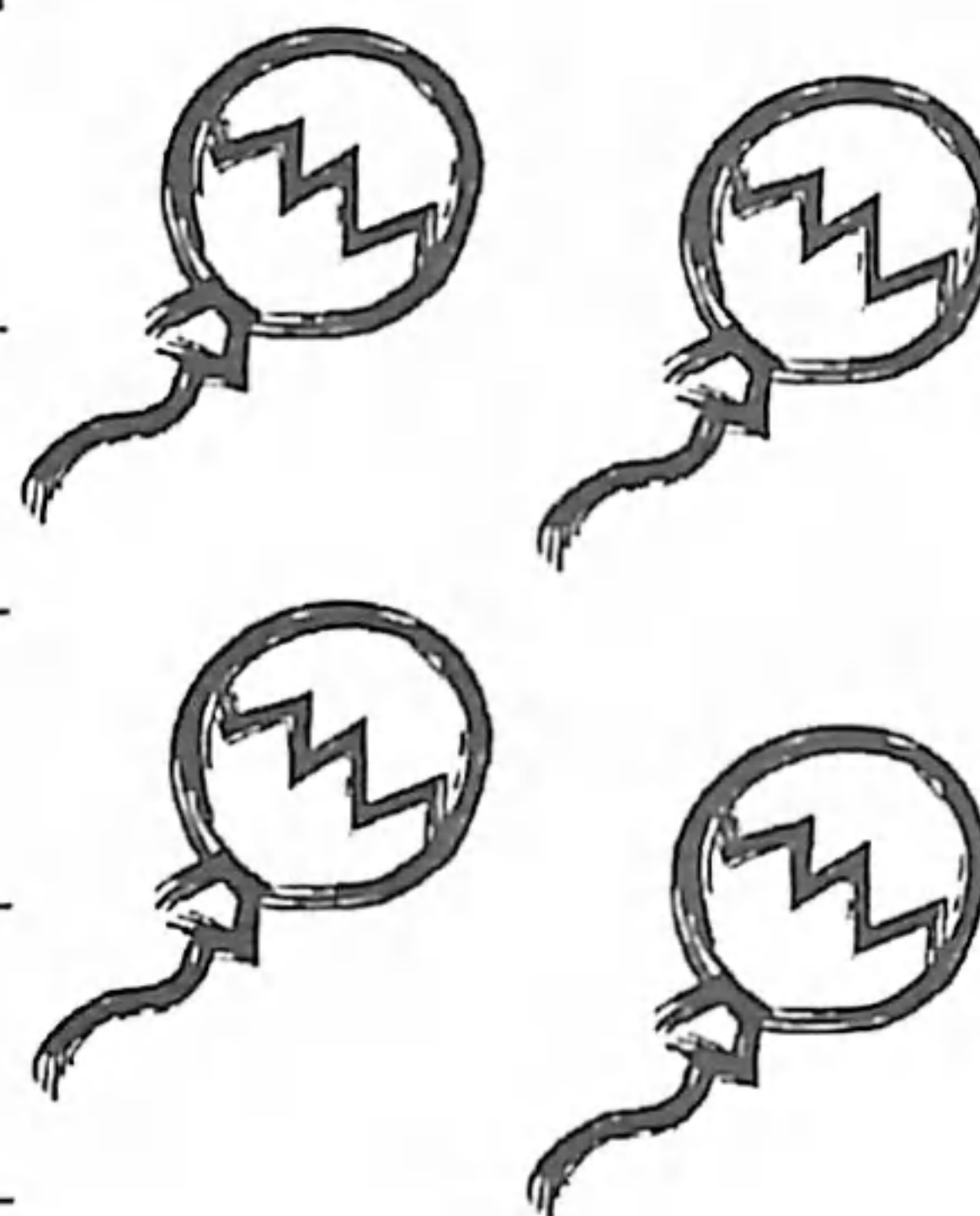

• Ri tijonel nusol rij achike ri jun tawila'. Chuqa' achike nk'atzin chi ke ri ak'wala'.
• Ri tijonel yerunük' pa molaj, k'a ri' nujäch ri jujun tawila' chi ke. Ri tijoxela' nkikanoj pa klyonil ri nuq'ajuj k'a ri' nkitz'ib'aj chuchi ri jujun xupuy.



Rub'eyal ye'etaman ri ak'wala'



Ri pa maya' na'oj, ri jun alk'walaxel, nretamaj pe rusamaj töq k'a ti ko'öl na. Pa nab'ey taq rujuna' ri ak'wal xa pa etz'anem nretamaj pe nsamäj. Ri kan pa rub'eyal ri', ri alk'walaxel k'o chi yeroqaj ri rute' rutata', wi pa ruwi' samaj, pa taq molojri'i'.

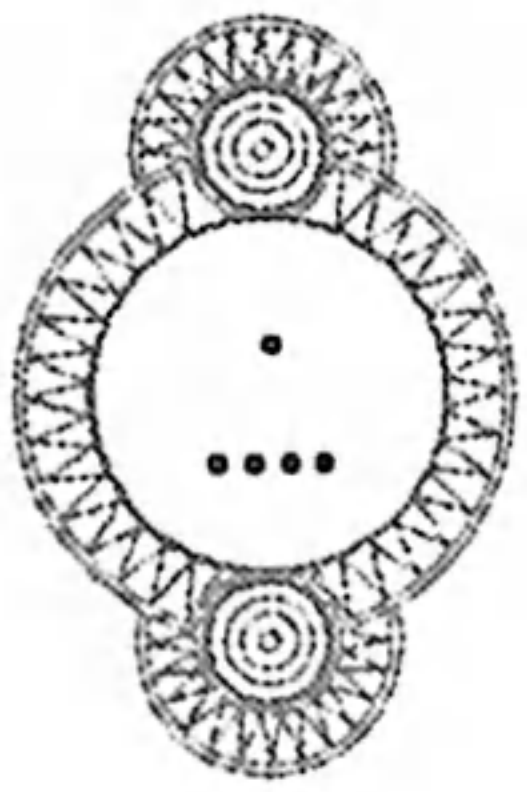
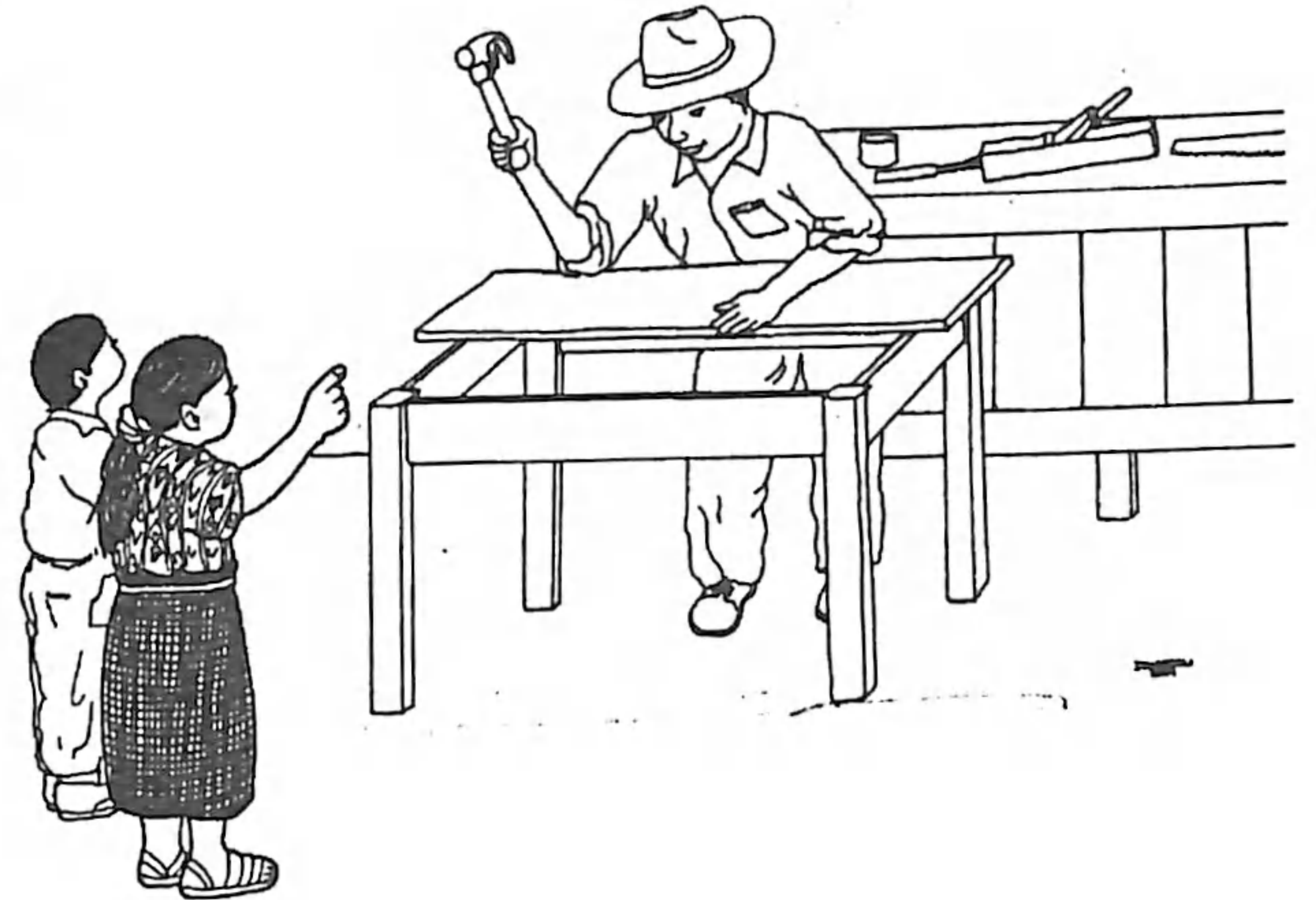

Pa molaj tqana'ojij, achike rub'eyal yetijox ri ak'wala wakami.

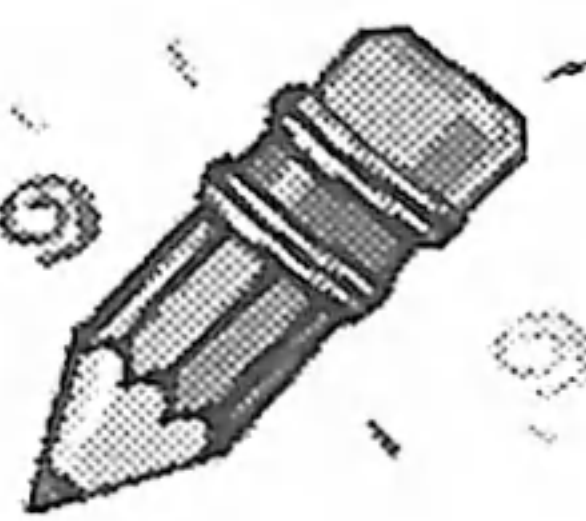
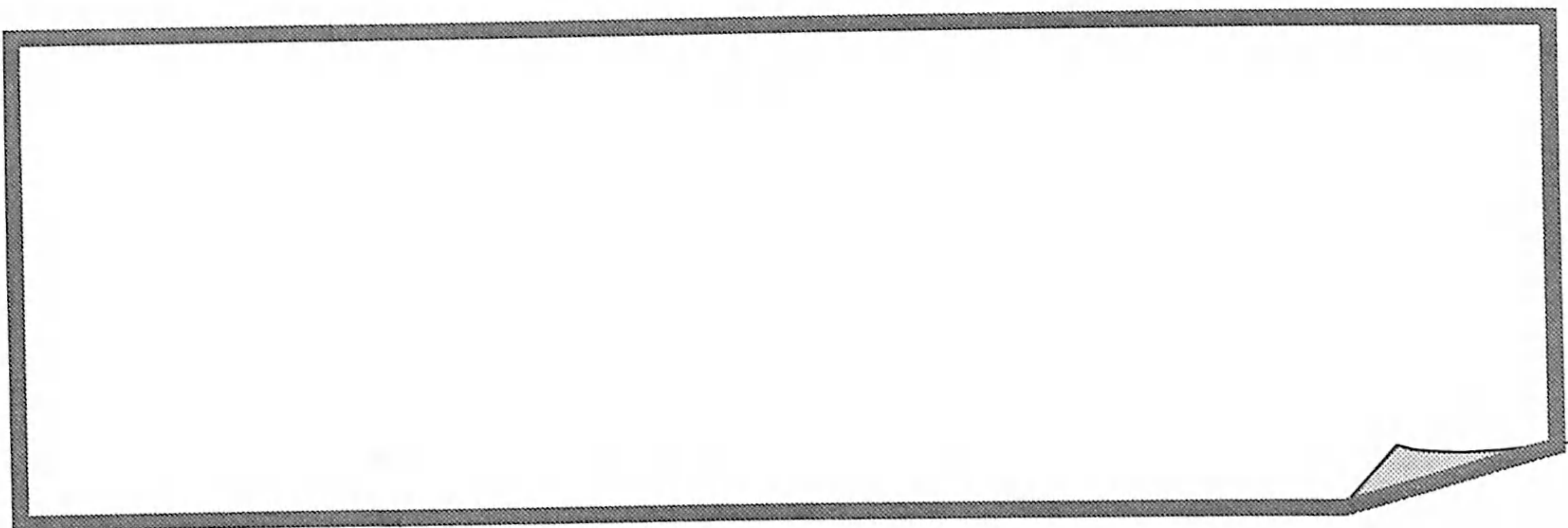

• Ri tijonel nutzijo] chi ke ri ak'wala ri rub'eyal yetijox ri ak'wala' ojer kan.
 • Ri tijonel yerunuk' ri tijoxela' pa molaj richin nkisamajij ri jun rukisib'äl solojsamaj.



Tqatzijoj, tqatz'ib'aj achike samaj yojtikir nqab'än.

Yojtzijon pa molaj, k'a ri' nqatz'ib'aj ri jalajöj samaj yojtikir nqab'än chi qajujunal, chupam re jujun kumatz'in wuj

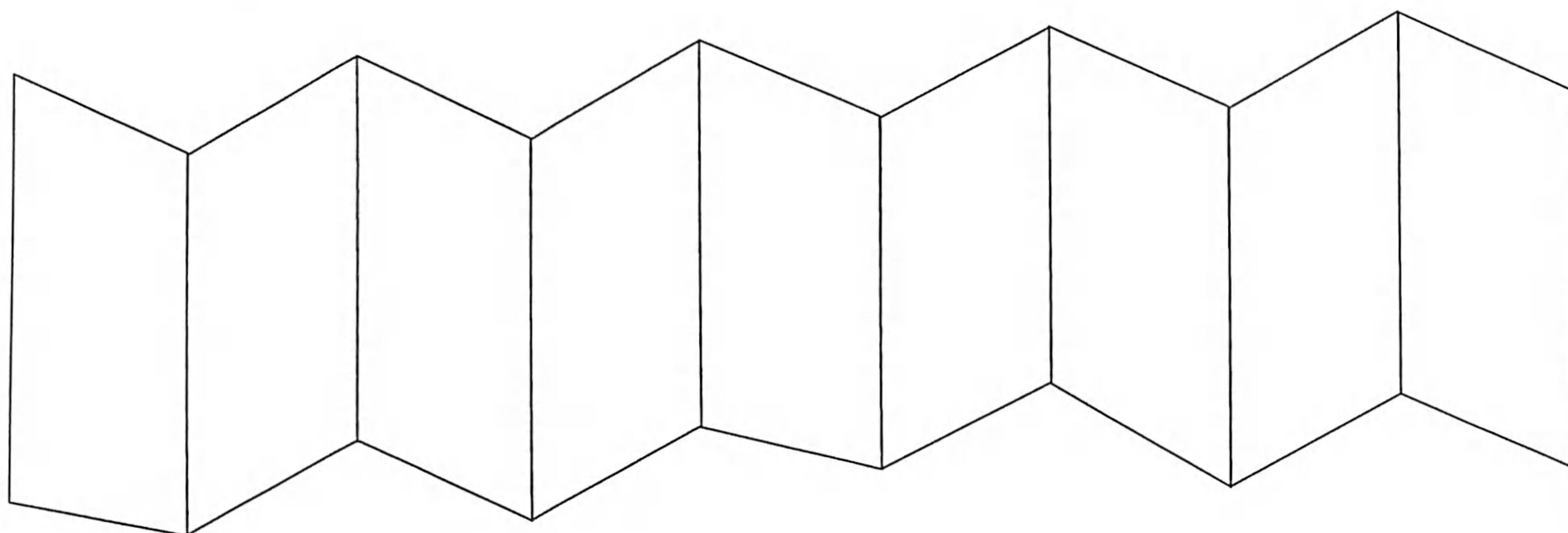

Tqab'ana rachib'äl jun samaj ri yojtikir nqab'än

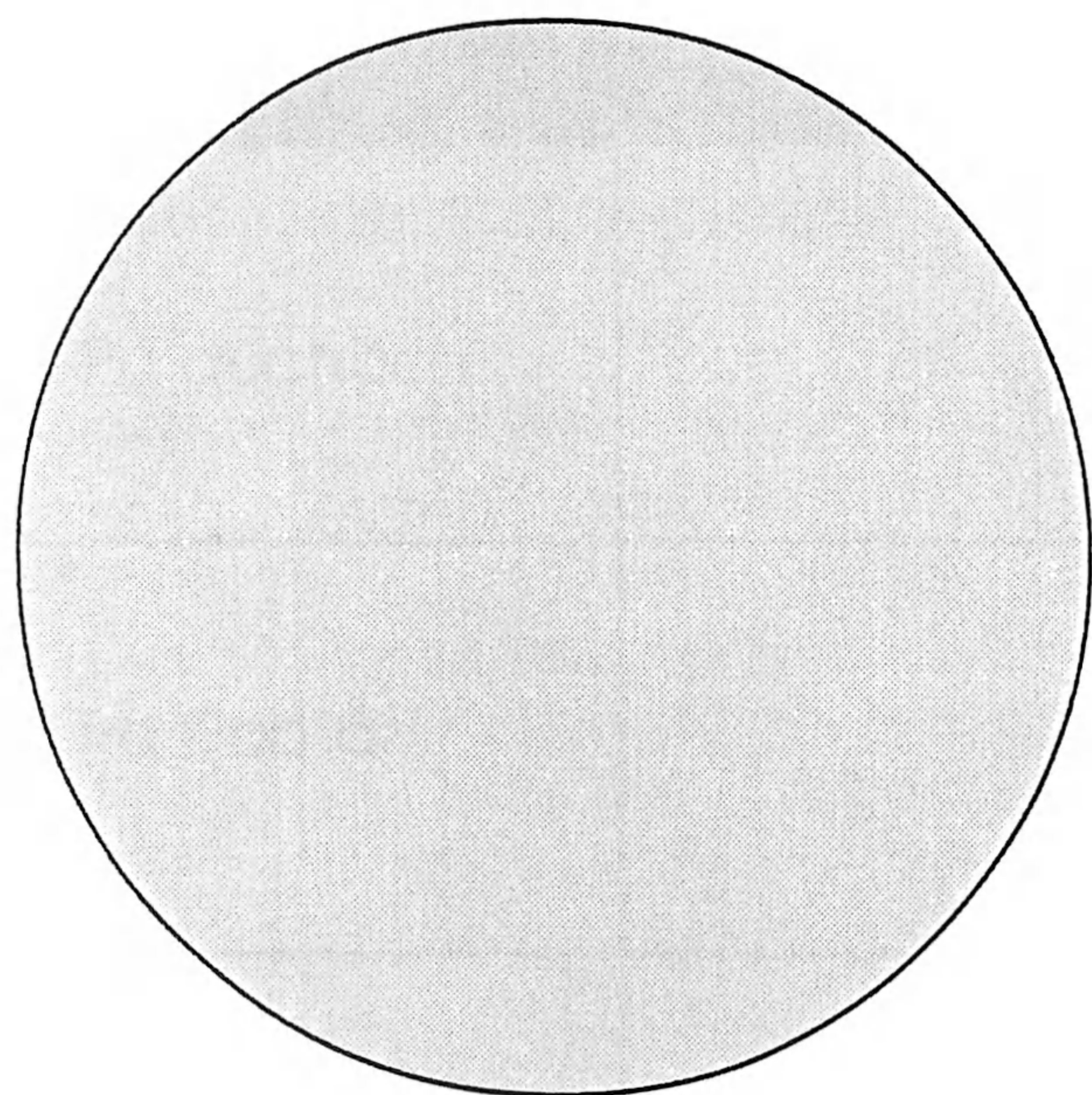

Ri samaj

Ronojel ri samaj k'atzinel nb'an rik'in **mitijul**. Ri jun winäq mitij, ja ri' ri nub'än rusamaj rik'in ronojel runa'ojib'al chuqa' pa rub'eyal, nuya' ronojel ri retamab'al rik'in chuqa' yerutz'uk jalajöj na'oj chupam ri rusamaj. Ronojel re na'oj re' ruximon ri' rik'in ri rupatan samaj ruk'amon pe pa ralaxb'al.

- . Ri tijonel yerunuk' pa molaj ri tijoxela' richin nkib'än ri nab'ey samaj.
- .. Ri tijoxel k'o chi nub'än ri jun ti achib'äl.
- ... Ri tijonel nusol chi kiwäch ri tijoxela' ri samaj.



Ri k'ayewal ruk'amon pe ri q'oral.



Ojer k'an ntzijox chi k'o jun
ala', man nurayij ta nsamäj, k'o jun q'ij
rija' kotz'öl pa ulew töq xutz'ët el chi kaj k'o jun
k'uch nb'iyaj rija' cha' ke re' xub'ij, tikirel ta yinok
k'uch rin, richin ta ke ri', xa xe ta yinb'iyaj xcha rija. Ri
k'uch cha' xrak'axaj ri nub'ij ri ala', ruma ri' xb'eqaqa
pe, xetzijon rik'in ri k'u'ch. Ri k'uch xub'ij chi re, we nawajo'
nqajäl qi', rat yatok k'uch, rin yinok ala', ützt k'a ncha ri
ala', xkijäl ki'. Töq nxik'an ri k'uch ala', xpe ruwa'ijal, k'a
ri xb'eruna' pe chi k'o chi nutij kaminäq taq äk' pa
taq siwan. K'a ri' xub'ij, man ützt ta re xinb'än,
xa ja ri man tikirel ta chik xtzolin pa nab'ey
ruk'aslem.

Tab'ana' jun achib'äl chi rij re na'oj xawak'axaj

- Ri tijoxela' nkisik'ij ri tzijonem, chi kijujunal.
- Ri tijonel nub'än k'utunik chi ke ri ak'wala'.
- Ri tijoxela' nkib'än ri achib'äl
- Pa ruk'lsib'äl, nkib'än ri pach'un tzij.



Tqatz'ib'aj achike samaj tikirel nqab'än kik'in ri ak'wala chuqa' q'opoji' k'ajola'.

Samaj tikirel nb'an kik'in ak'wala'

samaj tikirel nb'an kik'in q'opoji' k'ajola'

Achike ta samaj tikirel nqab'än pa qochoch, pa tijob'äl, pa qatinamit. Tqatz'ib'aj ri qana'oj.

Akuchi	Na'oj/samaj	Tab'ana jun ti rachib'äl
Pa qochoch		
Pa tijob'äl		
Pa qatinamit		

Ri fijonel nub'ixaj jun ti b'ix chi rij ri samaj, utziläj samaj rub'i'.

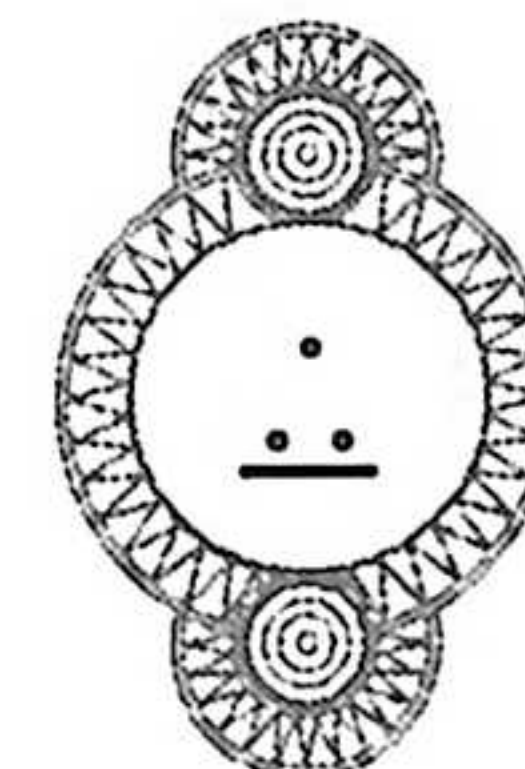

Rutzil ri samaj pa q'uch

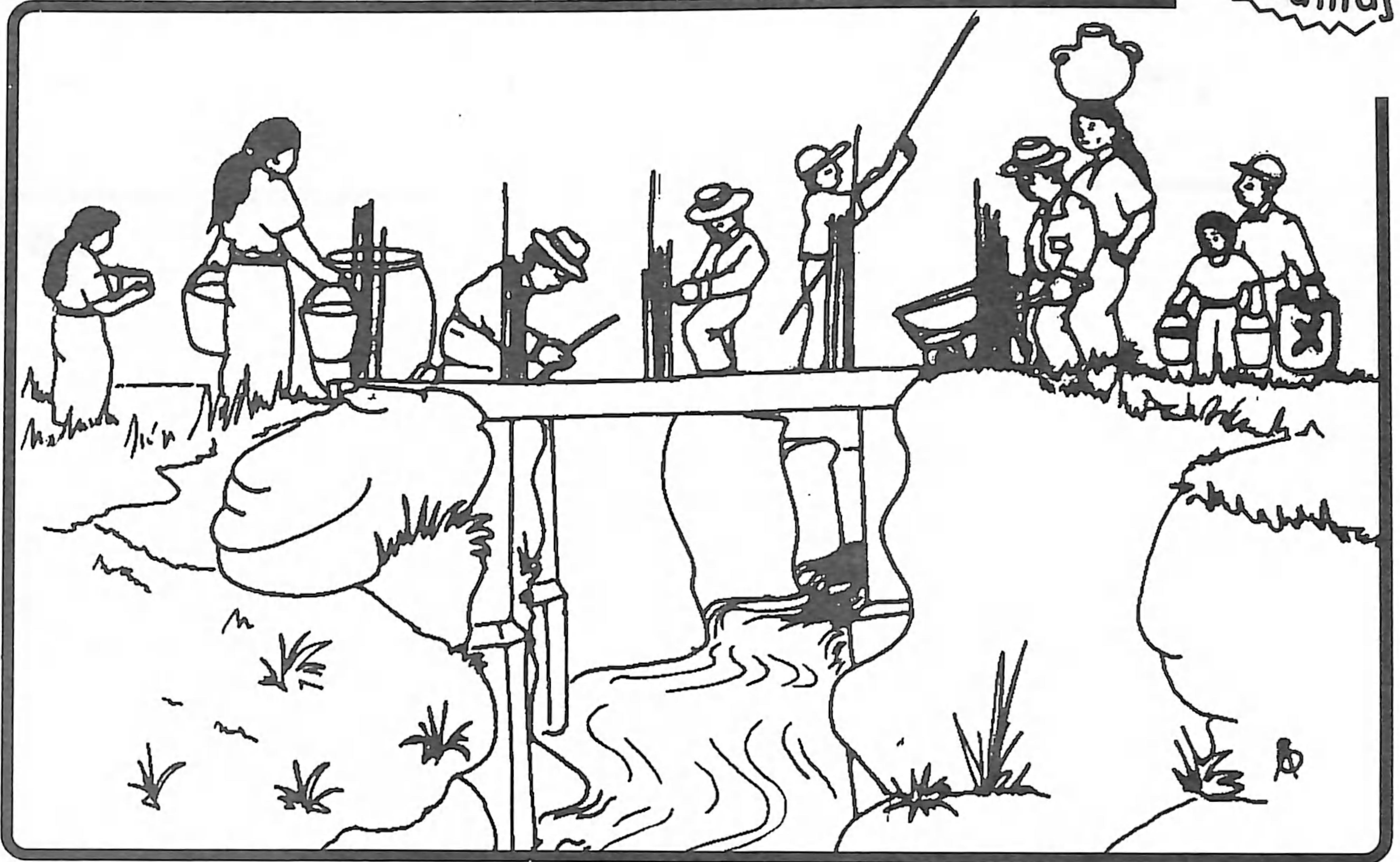

Ri qach'alal k'o jun rub'eyal nkokisaj richin nkib'an ri kisamaj. Re rub'eyal re', rub'ini'an samaj pa q'uch. Re jun rub'eyal samaj re' ja ri' töq konojel nkiya' kuchuq'a' pa ruwi' jun samaj, achi'el töq yejach'on, chuqa' pa rubanik jun jay.

Tqatz'ib'aj
achike ta
samaj fikire'
yeqab'an p
q'uch

Four horizontal lines for writing, enclosed in a rounded rectangular box.

- Ri tijonel ntzjon pa ruwi' ri samaj pa q'uch.
- Ri tijoxela' nkitz'ib'aj juley chik rub'eyal re samaj pa q'uch.



Ri na'oj tikirel nqaqb'än chi qochoch

Pa maya' na'oj, ri to'onik jun rub'eyal richin man k'ayew ta nab'än jun samaj, xa xe ke ri' tikirel yeqab'än nimaläj taq samaj.

Tqatz'ibaj na'oj pa ruwi' ri to'onik.

Tqatz'ib'aj akuchi tikirel vojto'on wi röj.

Large rectangular writing area with horizontal lines for text.

Tqatz'ib'aj achike ruwäch samaj e k'o

Large rectangular writing area with horizontal lines for text.



• Ri tijonel k'atzinel nusol rub'eyal ri rejqalem ri to'onik pa maya' na'oj.
• Ri tijoxela' yetz'ib'an pa ruwi' ri jujun k'utunik.

Xinwetamaj re jun ka'i' oxi' na'oj re'



Tqatz'ib'aj ri xuk'ulwachij ri jun ala' xok el k'uch.

A large rectangular writing area with horizontal lines and a pencil icon in the top right corner.

Tqatz'ib'aj achike rub'eyal nk'ut kisamaj ri ak'wala'.

A large rectangular writing area with horizontal lines and a pencil icon in the top right corner.

Wawe' ntojto'eb'ri retamab'al ri tijoxel, pa ruwi' ri xretamaj yan.

ROX TANAJ

Rokisaxik pa rub'eyal ri Kaqchikel Ch'ab'äl



Ri etamanik nuq'i' ri tijoxel:

Nutzijoj ri rejqalem ri Kaqchikel ch'ab'äl.
Nrokisaj pa rub'eyal ri ch'ach'el chuqa' latz' k'uxatz'ib'.
Nutz'ib'aj pa rub'eyal ri ch'akultz'ib'
Nutz'ib'aj pa rub'eyal ri retal sik'itz'ib'anem.
Nutz'ib'aj pa rub'eyal ri b'i'aj.
Nusol na'oj pa ruwi' ri kejqalem ri winaqi'
Nusol na'oj pa ruwi' ri ichinanel b'i'aj.

Rejqalem ri Kaqchikel Ch'ab'äl



Pa molaj nqatz'ib'aj kaji' taq na'oj pa ruwi' ri qach'ab'äl.
Tz'eteb'äl: Yitzijon pa Kaqchikel ch'ab'äl.

Tatz'ib'aj ri rub'i' ri ch'ab'äl nkokisaj ri awach'alal awik'in.

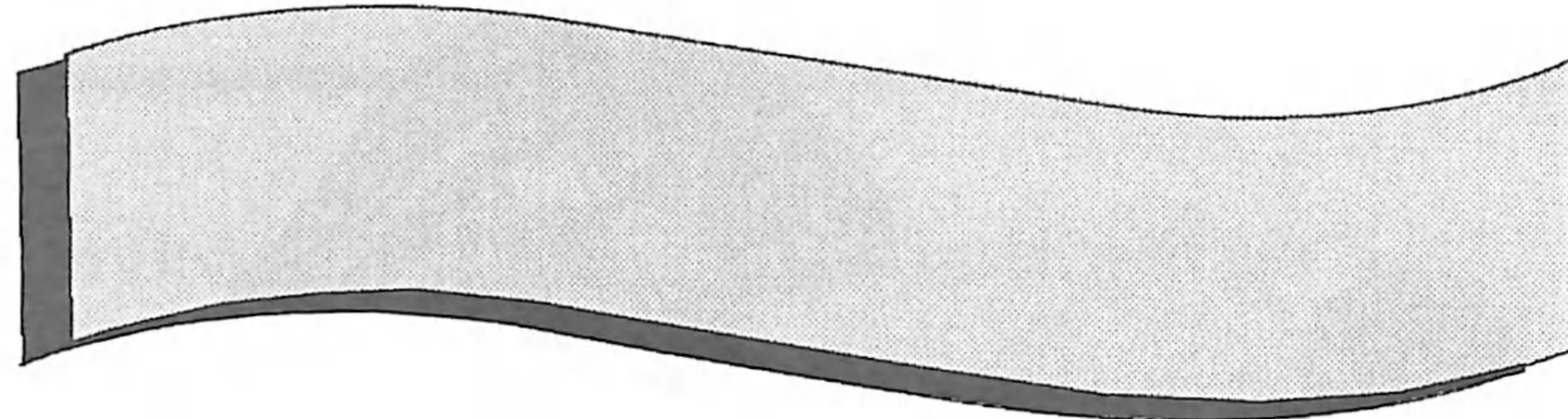

¿Kojbixan qonojel rik'in re jun b'ix re'?

Kaqchikel rub'i' ri nuch'ab'äl, la, la, la
yalan yikikot töq ninwokisaj, la, la, la
Kojtzijon pa qach'ab'äl, la, la, la
Kaqchikel Ch'ab'äl rub'i'. la, la, la

- .. Ri tijonel yerunuk' pa taq molaj ri tijoxela' rchin nkib'an ri nab'ey samaj.
- .. Ri tijonel kik'in ri tijoxela', nketemaj re jun b'ix.



Rokisaxik ri Ch'ach'el K'uxatz'ib'

Keqakanoj pa taluwuj, ri kachib'äl ri ch'ach'el k'uxatz'ib', keqaqupij k'a ri keqatz'arab'a' chupam re jun kajtz'uk re'.

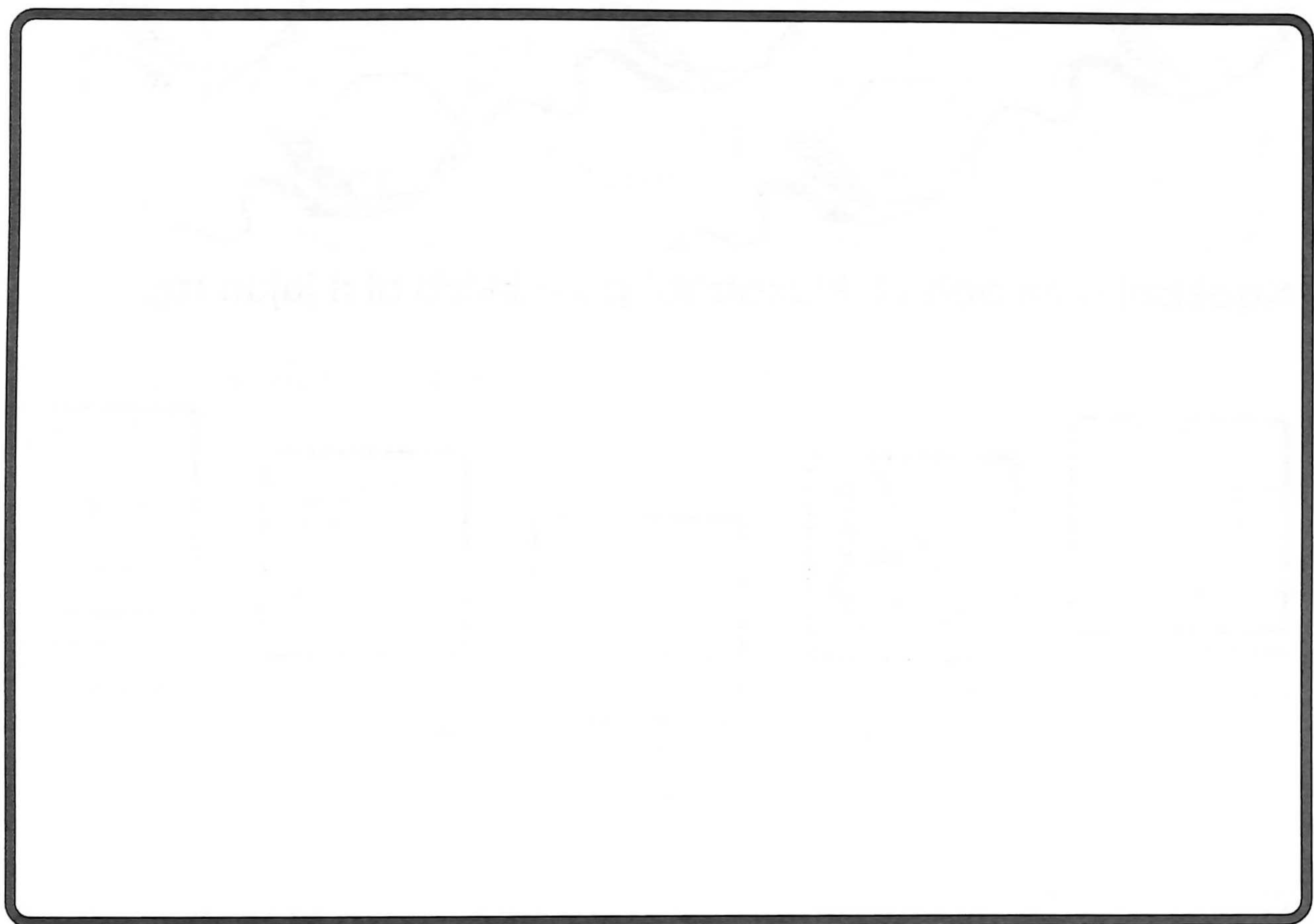

Keqatzib'aj kaji' tzij ri kik'wan ch'ach'el k'uxatz'ib'.

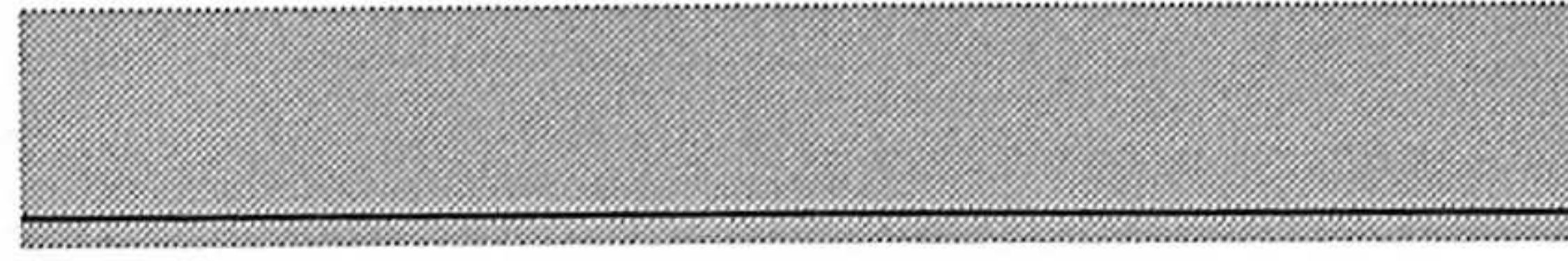
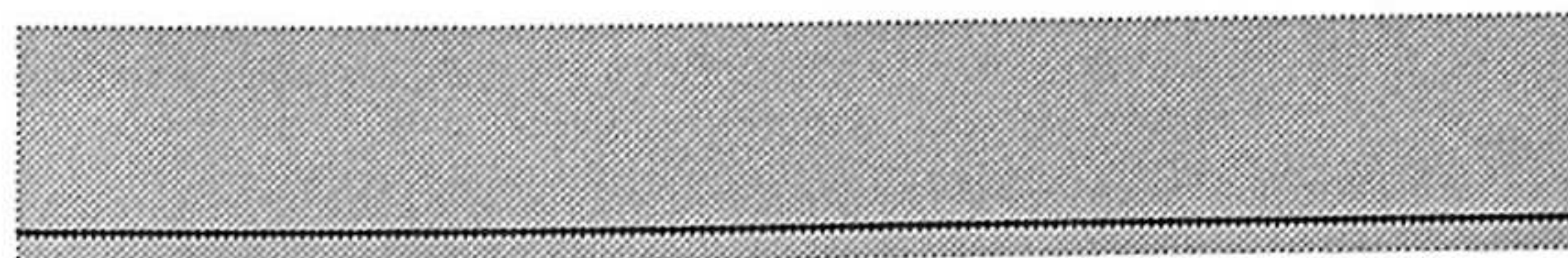
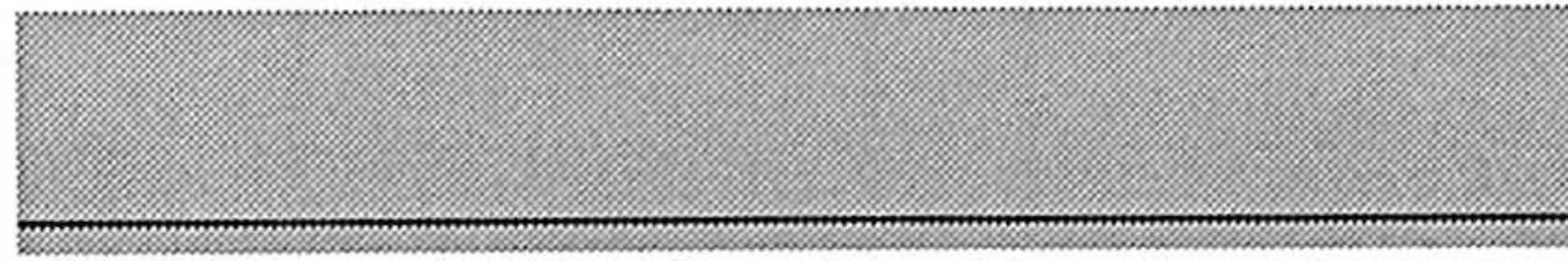
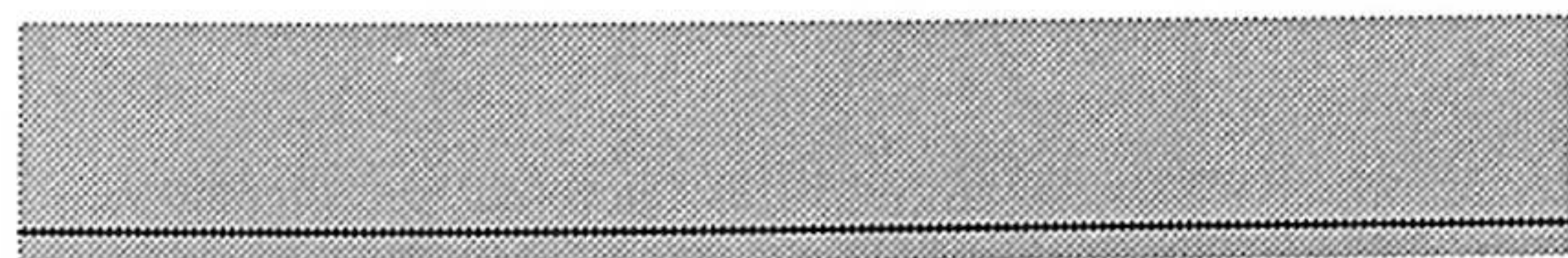

• Ri tijonel ntzijen pa ruwi' ri ch'ach'el k'uxatz'ib'.
•• Ri tijonel tikirel nuk'utuj el ruxaq wuj chi ke ri tijoxela', richin nkiqupij ri faq tz'ib'.

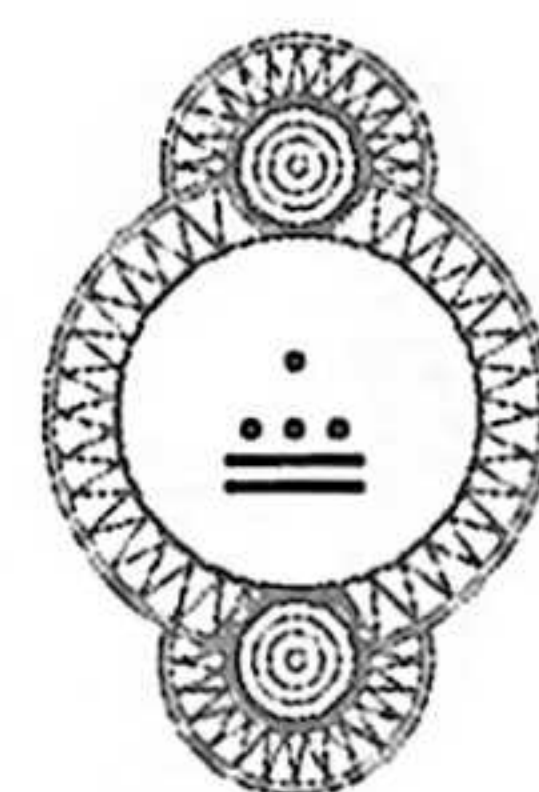

Nqokisaj pa rub'eyal ri ch'ach'el K'uxatz'ib'



Nqatz'ib'aj chi jujun ri ch'ach'el k'uxatz'ib', chi kipam re jujun taq tok'är (xik'awuj).

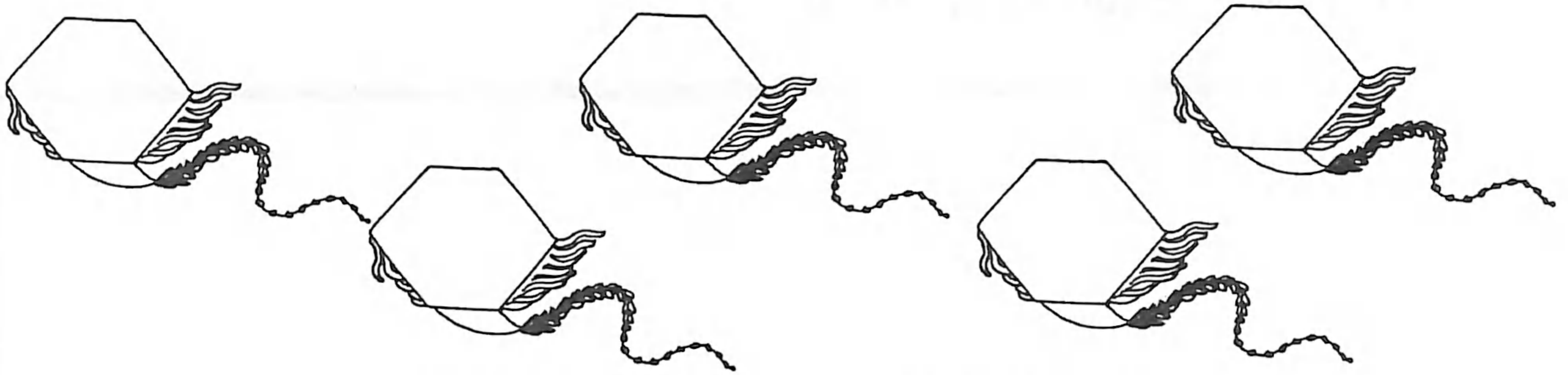

Nqokisaj ri ch'ach'el k'uxatz'ib' pa rutikirib'al ri jujun tzij.

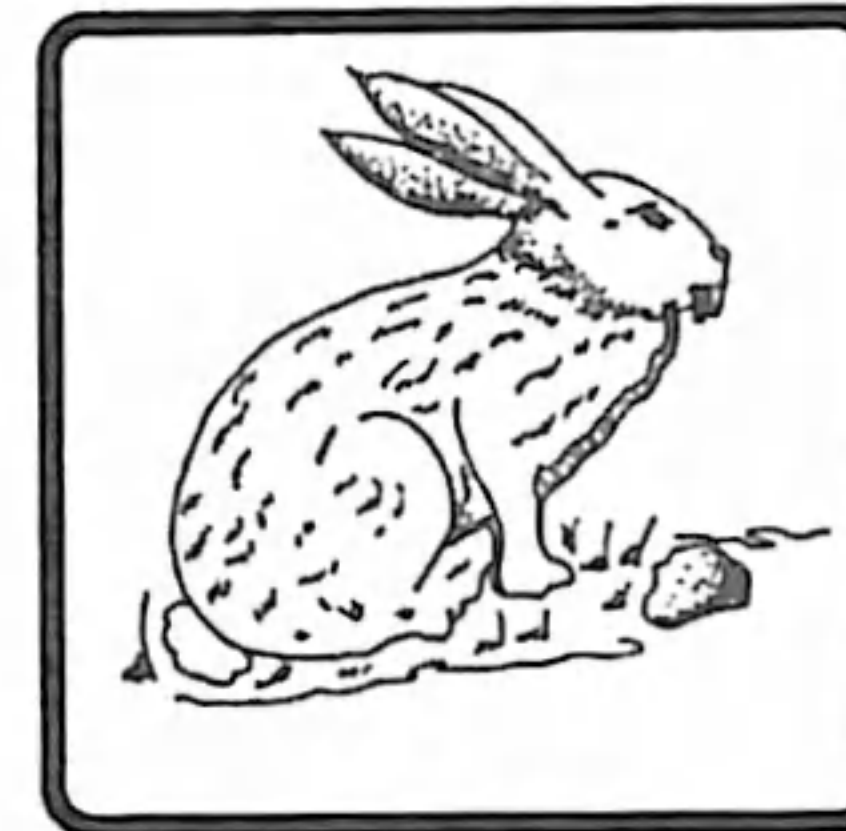
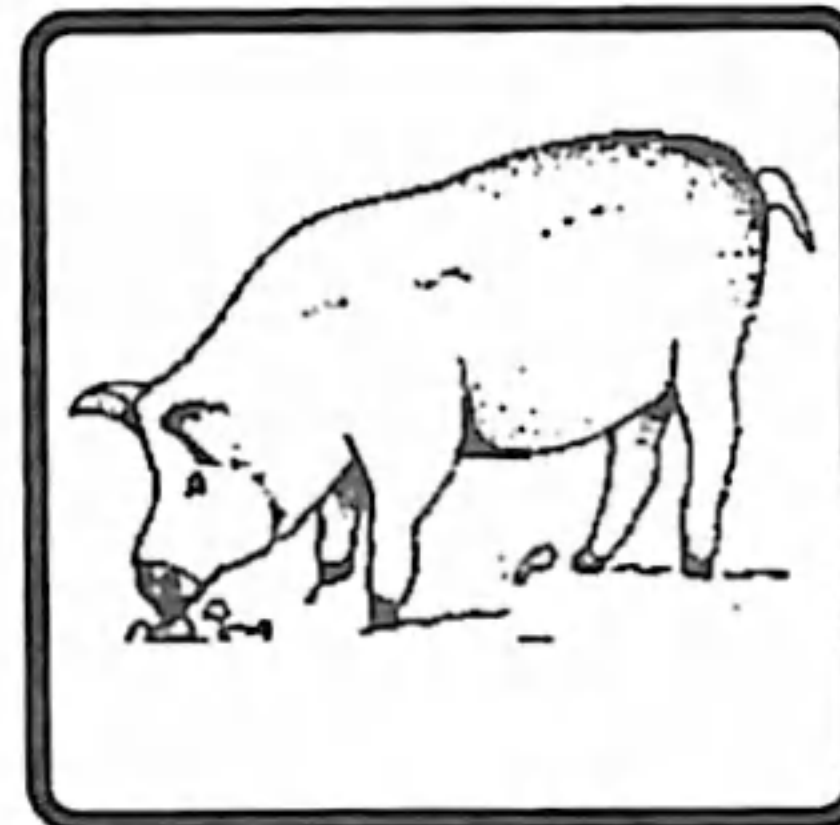
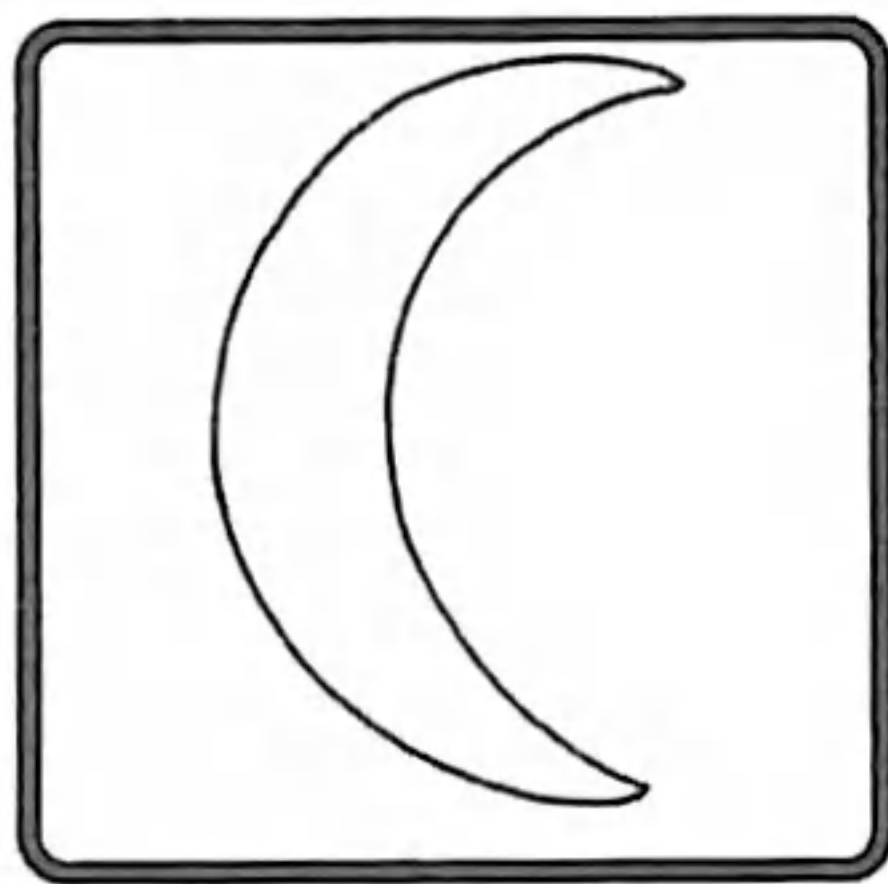

Nqokisaj ri ch'ach'el k'uxatz'ib' pa runik'ajal ri jujun tzij.

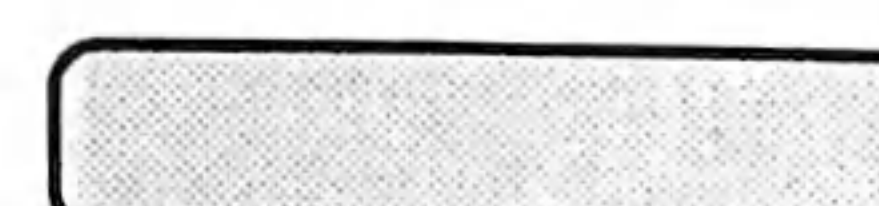
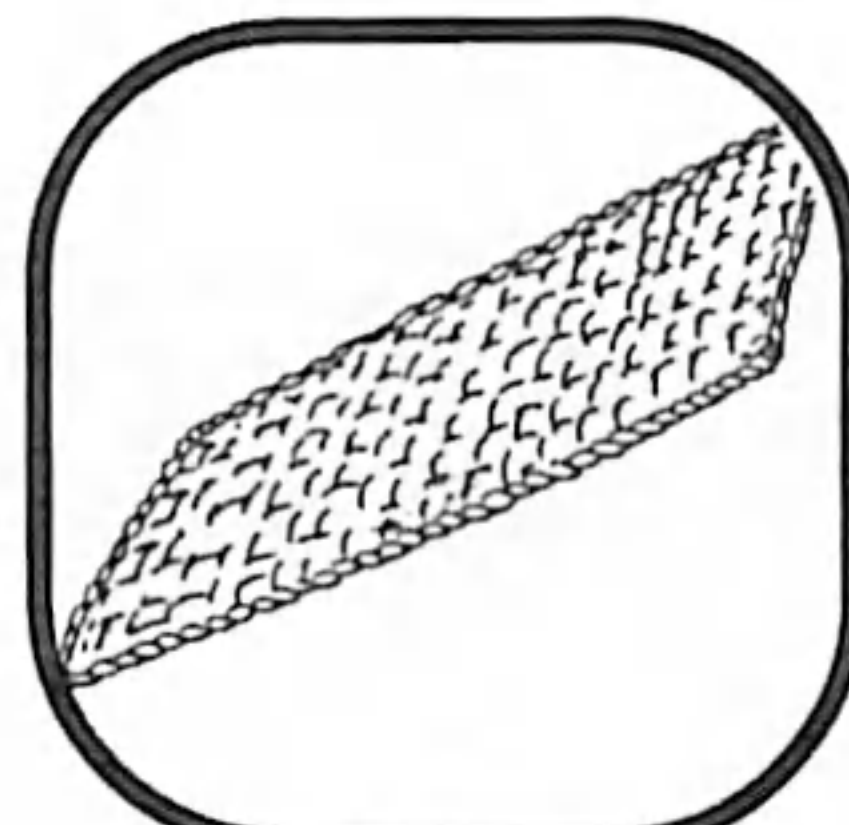

- Ri tijonel nusol chi kiwäch achike ri ch'ach'el k'uxatz'ib'.
- Ri tijoxela' nkitz'ib'aj rub'1' ri achib'äl.



Rokisaxik ri latz' k'uxatz'ib'

¿Nqetamaj kiwäch ri latz' k'uxatz'ib'?
Keqatz'ib'aj chi kipam re jujun yakb'äl re'.

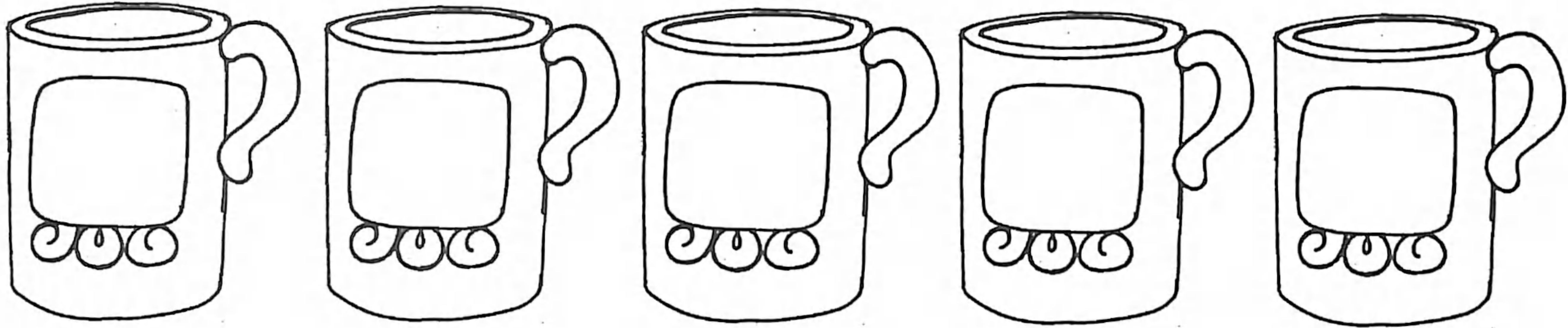

Keqatz'ib'aj tzij ri nkokisaj latz' k'uxatz'ib'.

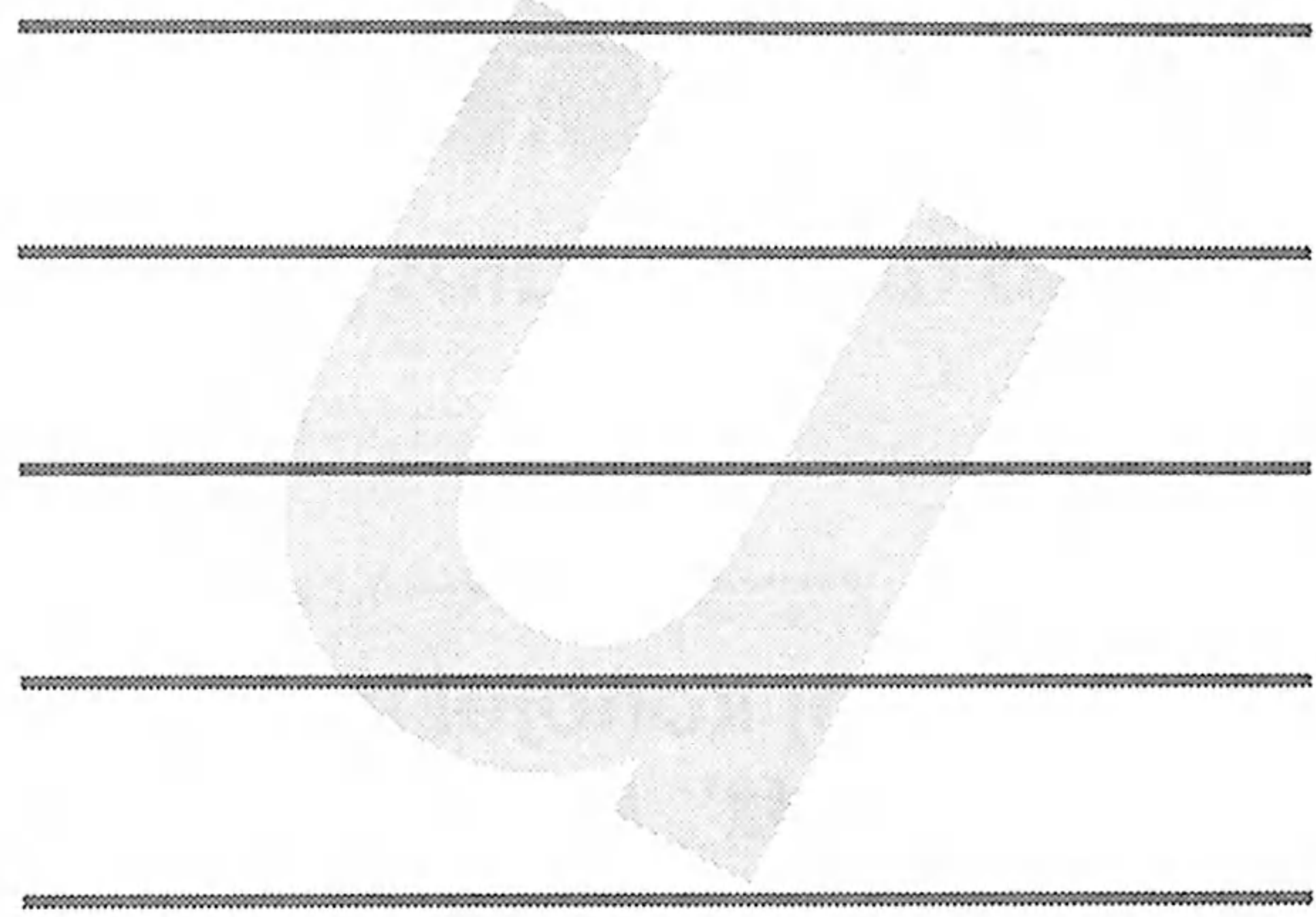
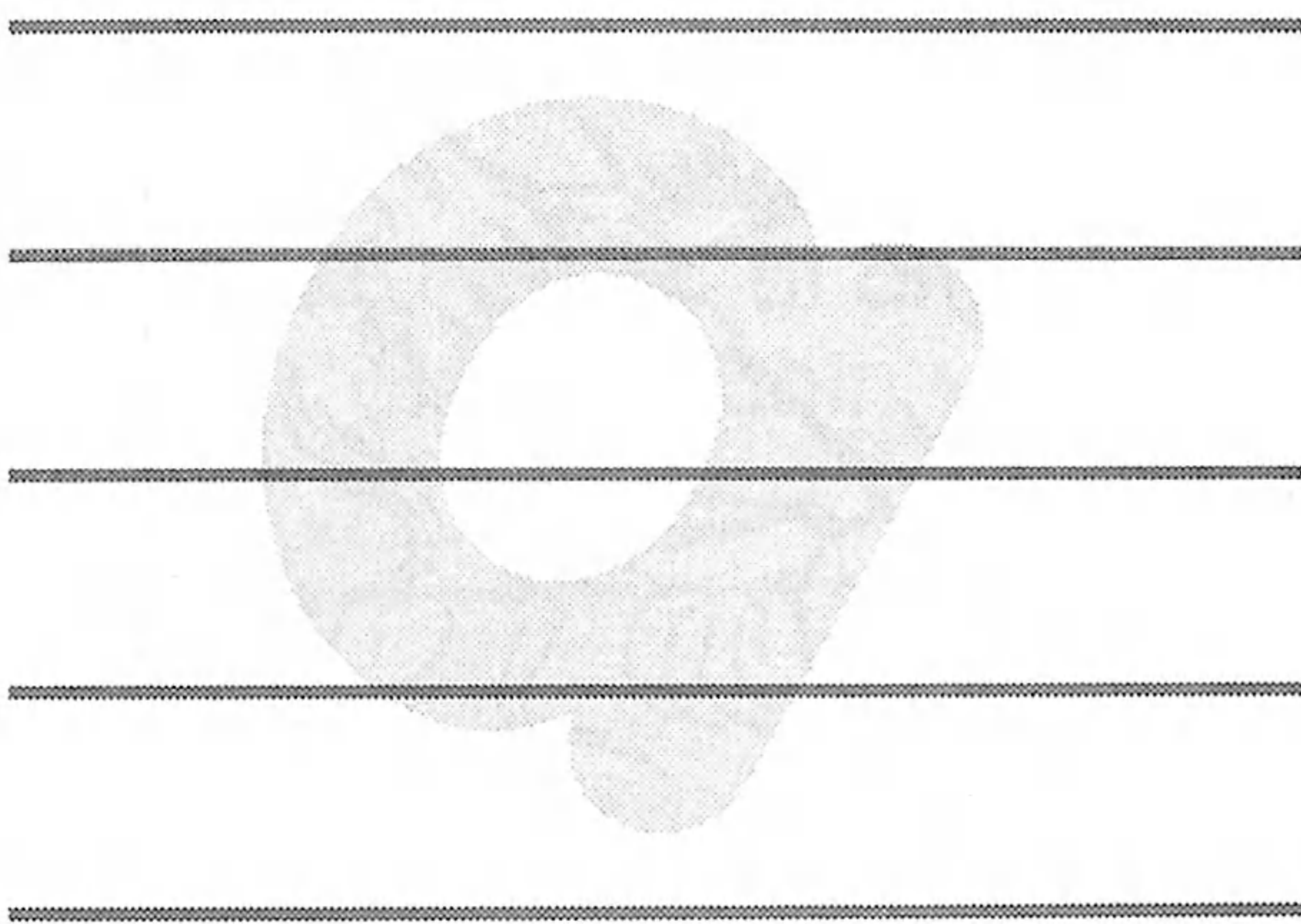

Tqatz'ib'aj wo'o' taq b'ab' akuchi ye'okisäx ri latz' k'uxatz'ib'.

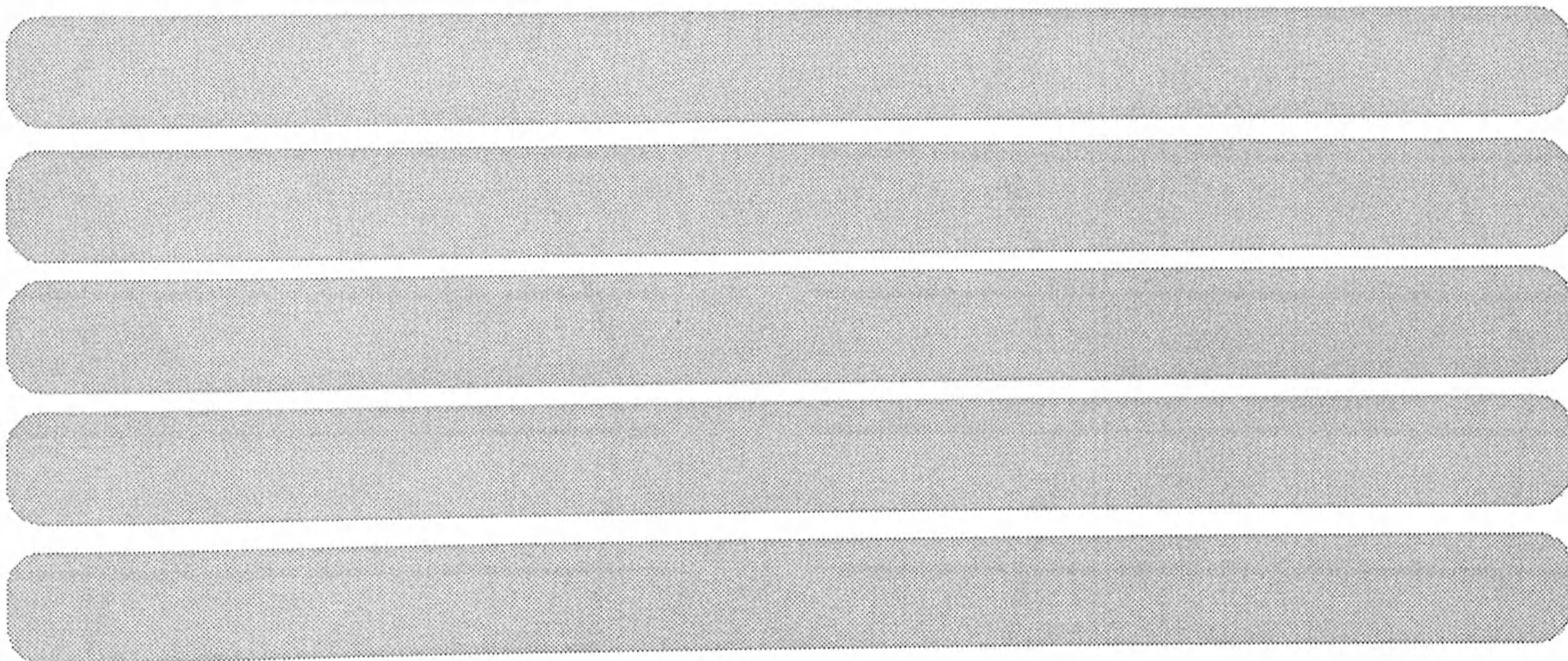

• Ri tijonel nusol rij, achike ri' ri latz' k'uxatz'ib'.
•• Ri tijoxela' nkib'än ri nk'utux chi ke.



Ri Loq'oläj Ya'

Ri loq'oläj ya' nuya' k'aslem, chuqa' ruk'wan kamik, töq nupo' pe ri' chi q'eqäl jäb', chi kaq'iq' jäb', ruma chuqa' tikirel yerumuq jay, yerumuq tinamit, yerumuq tiko'n. Ke re' k'a ri' töq nb'ix chi chuqa' ri loq'oläj ya', nuya' k'aslem nuya' kamik. Ruma k'a ri' töq nkib'ij ri qate' qatata', chi k'atzinel nya ruq'ij ri ya', man titz'iloq, man xa toyowär, tikirel yojrumuq, yojrukich, yojrub'it, yojrukamisaj, chuqa', töq ri jäb' man xtipe ta chik yojkäm qonojel.

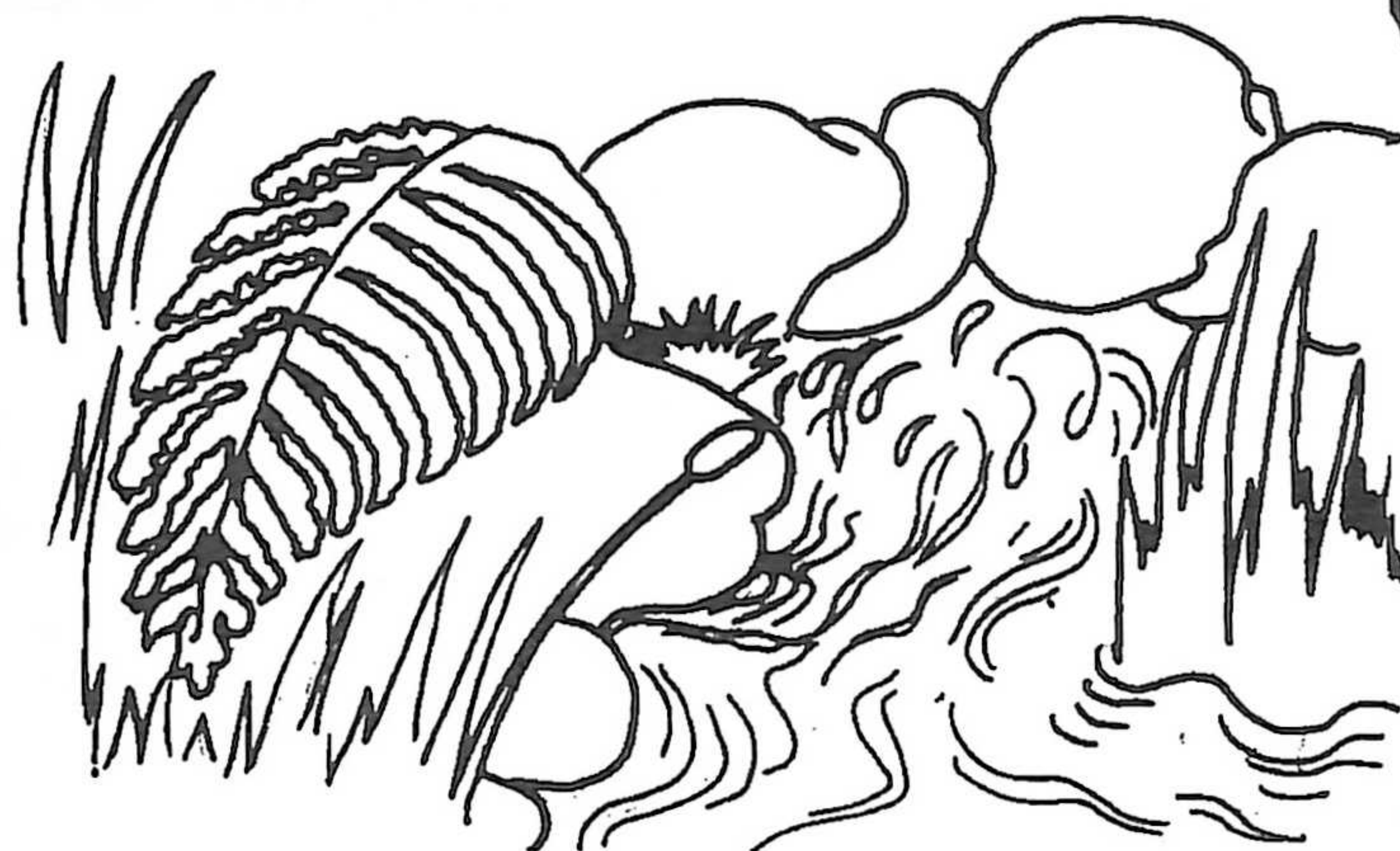

Keqakanoj konojel ri tzij
nkokisaj latz' k'uxatz'ib'.

Keqatz'ib'aj chupam re taq juch' re'.

Handwriting practice lines with a large faint letter 'a' in the background.

Handwriting practice lines with a large faint letter 'u' in the background.

- Ri tijoxela' nkisik'ij ri tzijonem pa ruwl' ri loq'oläj ya'.
- Ri tijonel yeruya' pa ch'ob'oj ri tijoxela' rik'in jalajöj taq k'utunik.



Kokisaxik ri jalajöj retal Sik'itz'ib'anem.

Tqatz'ib'aj ri retal sik'itz'ib'anem nk'atzin richin natz'ib'aj jun ka'i' oxi' na'oj chuwäch wuj.



Tqab'ana rachib'äl chuqa' tqatz'ib'aj ri taq retal sik'itz'ib'anem yalan k'atzinel richin yojtz'ib'an.

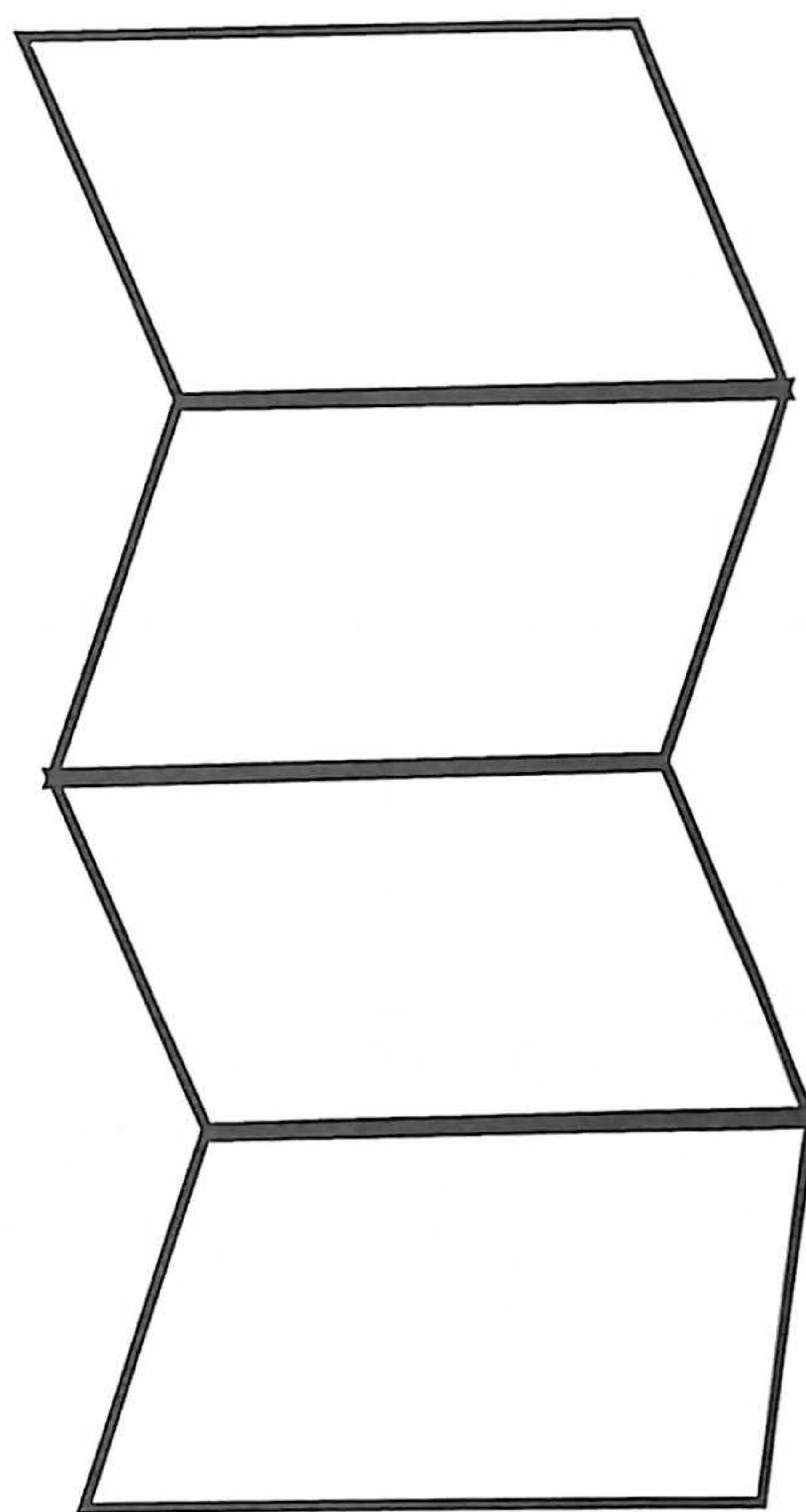
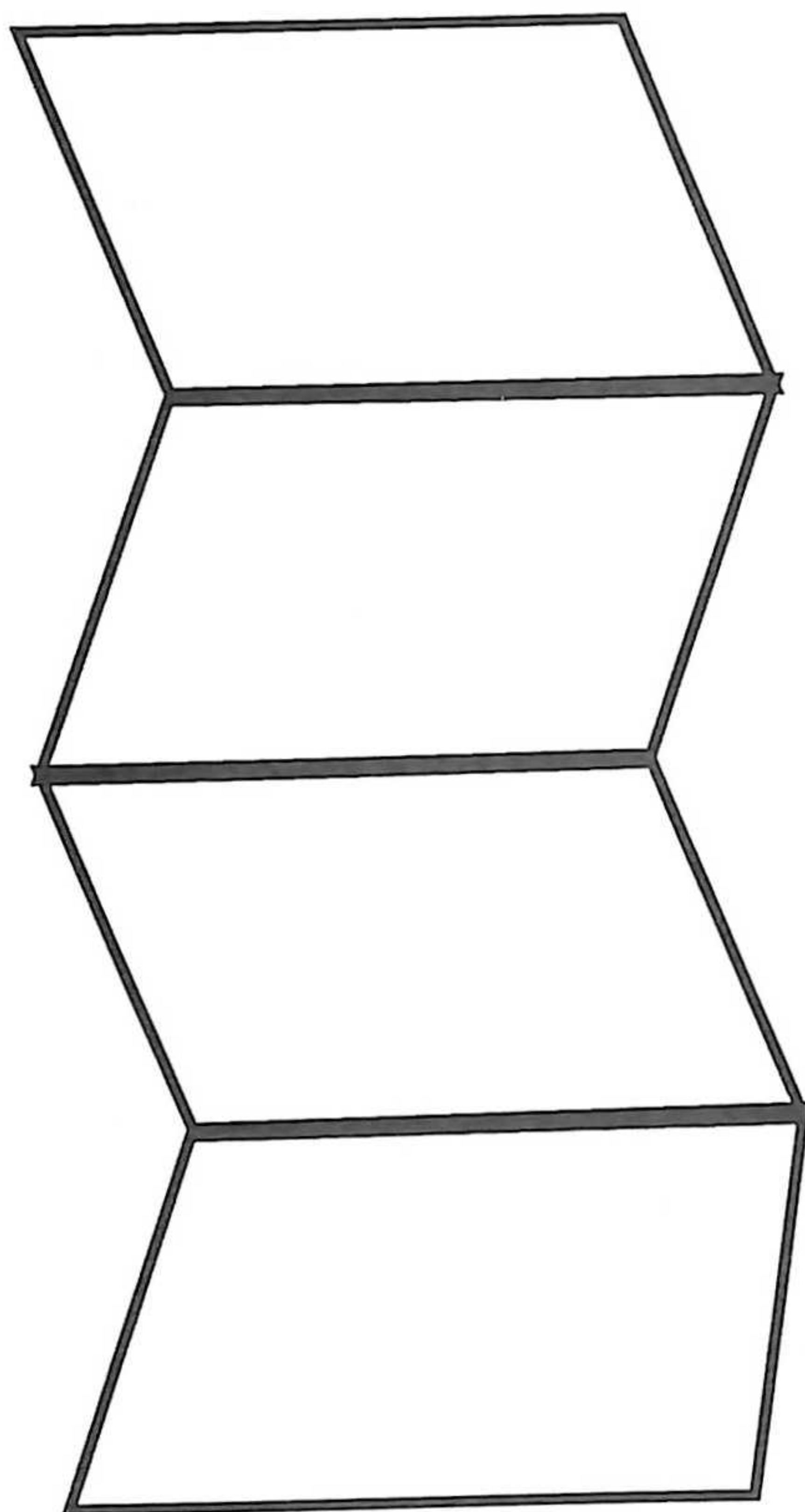

Ri tijonel k'atzinel nutzijoj, achike nuq'ajuj jun etal: wi chuwäch wuj, chuwäch kaj, pa b'ey, richin eqal eqal ye'ok chupam ri na'oj ri tijoxela'.



Solojsamaj



Keqakanoj achike retal sik'itz'ib'anem e k'o chupam re jun ti tzijonem re'. Töq xkeqil yeqatz'ib'aj chupam re jujun kajtz'uk.

Ri kaq'iq' man tz'etël ta, chuqa' man tikirel ta nachäp, xa xe nana', we manaq ta, man ta k'o k'aslem. Ri ulew, tz'etël, chuqa' tikirel nachäp, man ta k'o, man ta k'o qaway, manaq ta chuqa' choj pa ruwi' öj pa'al wi.

Retal Sik'itz'ib'anem

Ja ri', ri jujun taq etal ri nokisäx töq ntz'aqät jun na'oj. Chuqa' nokisäx richin yerujäch kokoj taq na'oj chuqa' richin nab'an k'utunik.

Tqatz'ib'aj achike rub'eyal yeqokisaj re jujun etal.

1. _____
2. _____
3. _____

- Ri tijonel nutzijoj chi ke ri fijoxela', achike nuq'ajuj ri retal tz'ib'anem.
- Ri fijoxela' kow nkisik'ij re jun ti tzijonem re'.
- Ri fijoxela' nkitz'ib'aj ri nk'utux chi ke.



Keqakanoj ch'aqa' chik retal sik'iz'ib'anem
chupam re jun tzijonem re'. Töq xkeqil yeqatz'ib'aj
chuwäch re jun ti ko'ol tz'aläm tz'ib'ab'al.

... Man ütztä ri nkib'ij!, ¿La man e tz'aq e b'it
ta k'a? ¡Xa kan Kab'awil chik xtikib'ini'aj! ¡Mani
xkepuq xkewinaqir, töq xke'awex ok, töq
xke'aläx ok!, ¡Mani yek'iyir! Ke ta k'a ri.

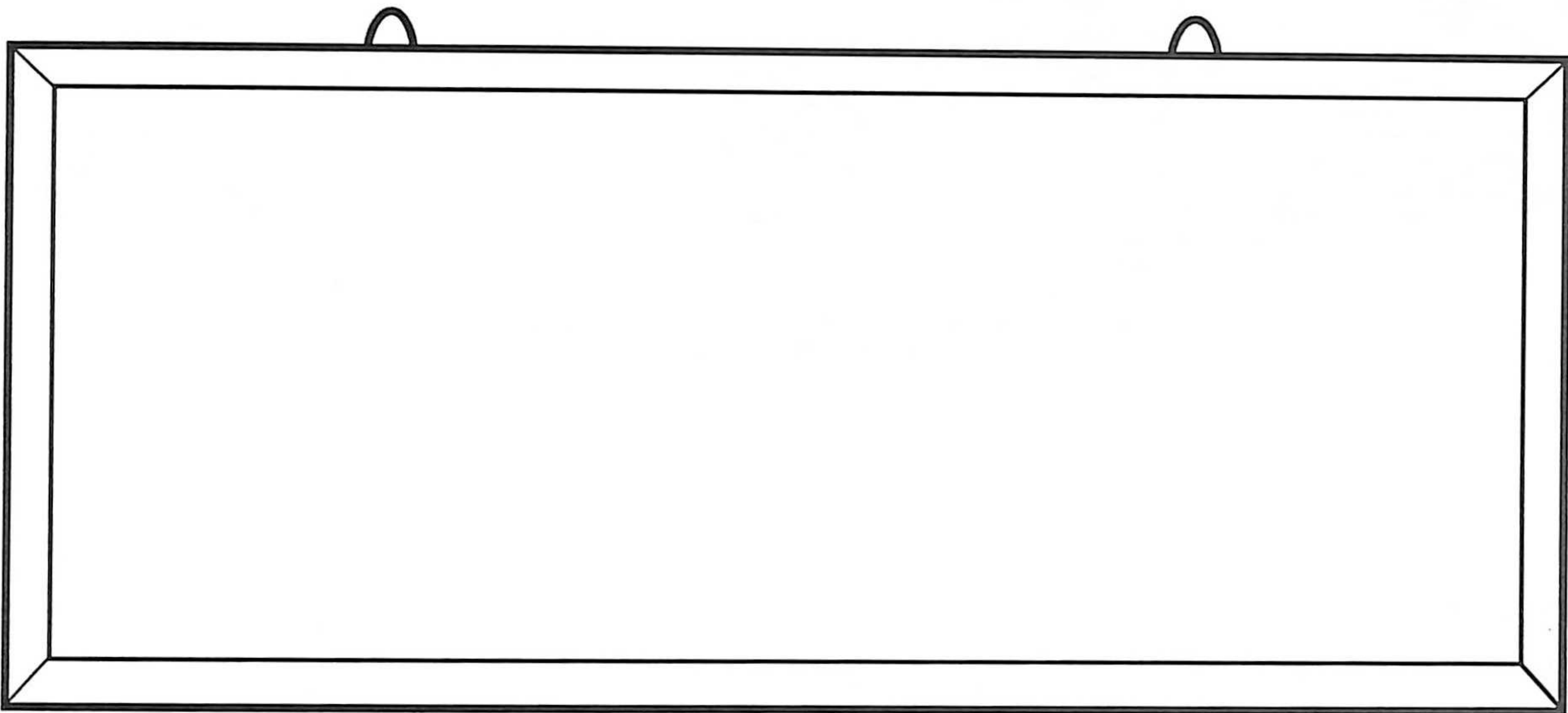

Yeqacholajij konojel retal sik'itz'ib'anem xeqil
yan, k'a ri' yeqatz'ib'aj chi kipam ri ruch'akul re
jun ti jut.



- Ri tijonel nusik'ij chi kiwäch ri tijoxela' ri jun ti ko'öl tzijonem.
- Ri tijoxela' k'o chi yekijuch' chi kixe' ri jujun tzij kik'wan latz' k'uxatz'ib'.



Rokisaxik ri ch'akultz'ib' kik'wan ch'ut



Ri ch'akultz'ib' ja ri', ri jujun tz'ib' kik'wan jun ti ch'ut xekixikin. Re tz'ib' re' e ja re' ri kan yerokisaj ri Kaqchikel ch'ab'äl.

Keqokisaj re jun ka'i' oxi' tz'ib' re':

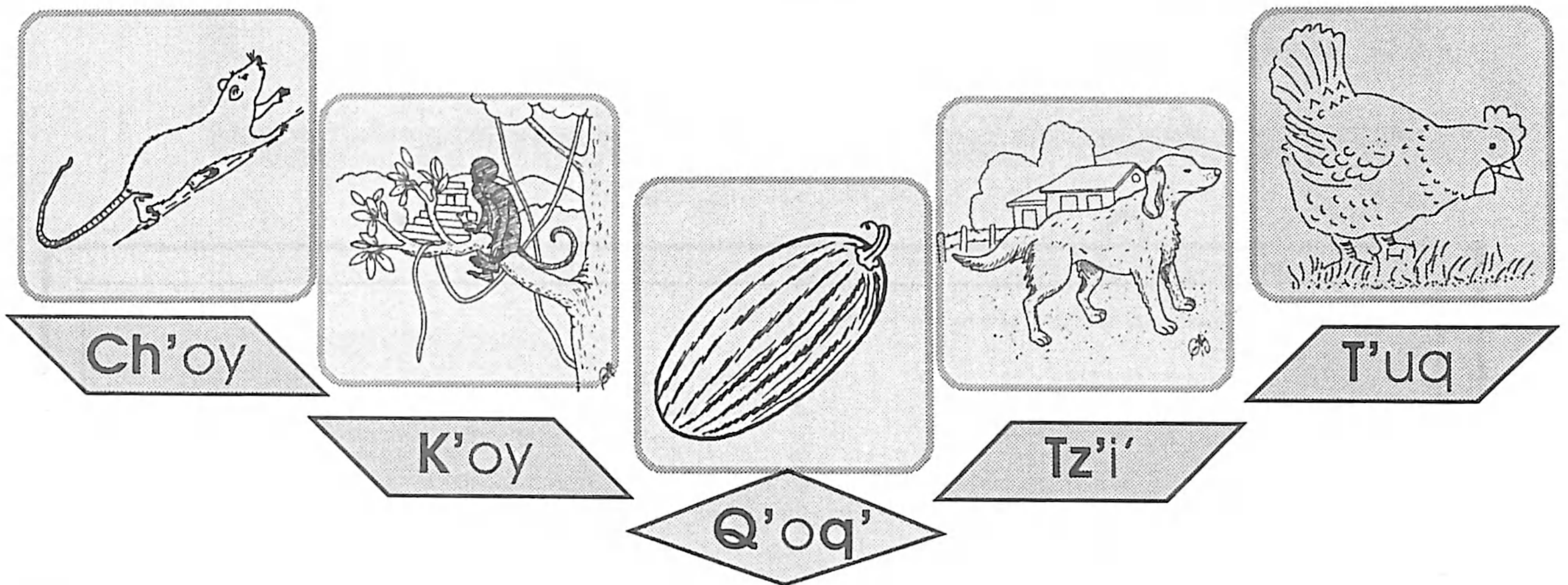

Keqatz'ib'aj ch'aqa chik tzij, akuchi yeqokisaj ri ch'akultz'ib' kik'wan ch'ut pa rufikirib'al , pa runik'ajal pa ruk'isib'äl.

Jun ka'i' tz'eteb'äl:

ch'ab'äq

ach'i'y

ib'och'

_____	_____	_____
_____	_____	_____
_____	_____	_____
_____	_____	_____
_____	_____	_____

- Ri tijonel k'o chí nuya' chi kiwäch ri tijoxela' achike ri ri ch'akultz'ib' kik'wan ch'ut.
- Ri tijonel k'o chí nuya jalajöj wuj chí ke ri tijoxela' richin yekikanoj ri tzij nk'utux chi ke.



Kikojolil ri ch'akultz'ib' kik'wan ch'ut, ri pa kiyonil. Rik'in ri e k'o pa k'ulaj

Richin jeb'ël ruk'oxomal ri Kaqchikel ch'ab'äl, yerokisaj ri ch'akultz'ib' kik'wan ch'ut.

Ch'akultz'ib' kik'wan ch'ut ri e k'o pa kiyonil

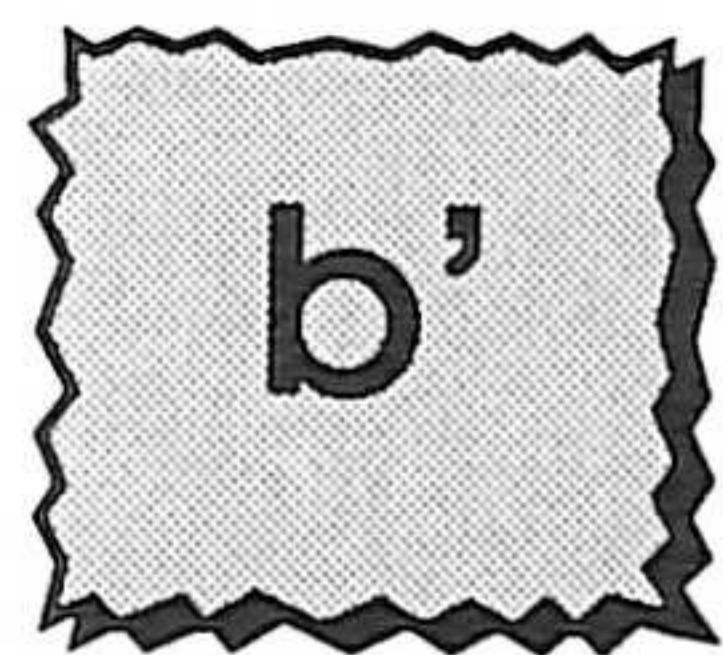

b'ey
sub'an
xajab'

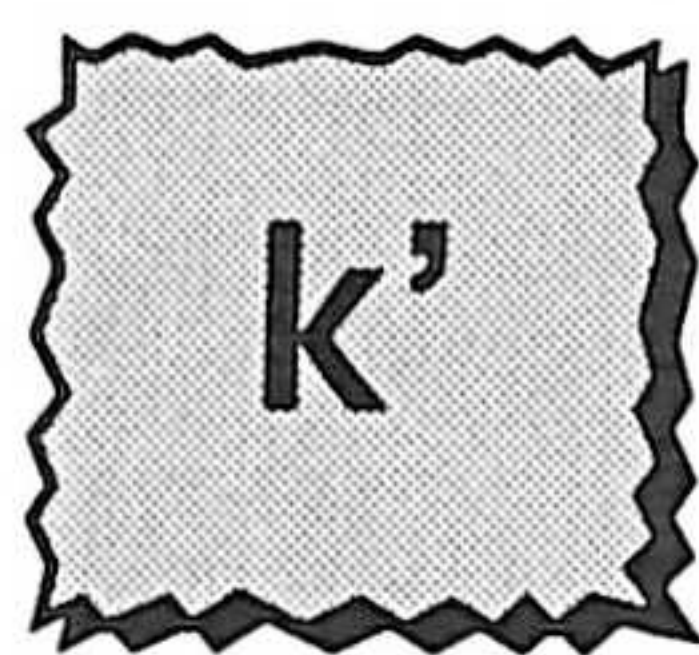

k'äy
uk'a'
ik'



q'ij
saq'ul
q'oq'



t'ot'
t'oj
t'uq

Ch'akultz'ib' kik'wan ch'ut ri e k'o pa k'ulaj



ch'ab'äq
pich'o'l
jäch'



tz'i'
kotch'öl
sutz'

Ri ch'ut pa ruyonil

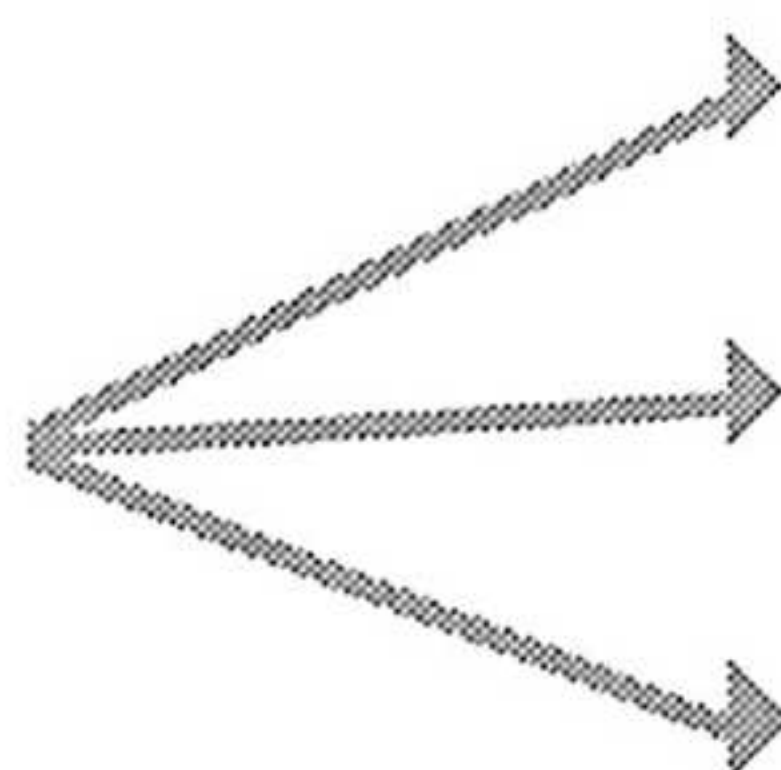
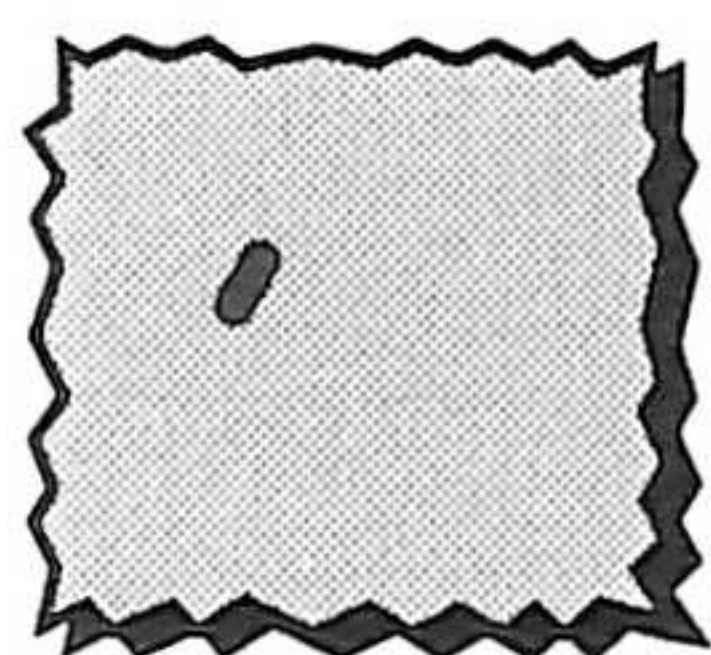

na'oj
ti'ij
ya'

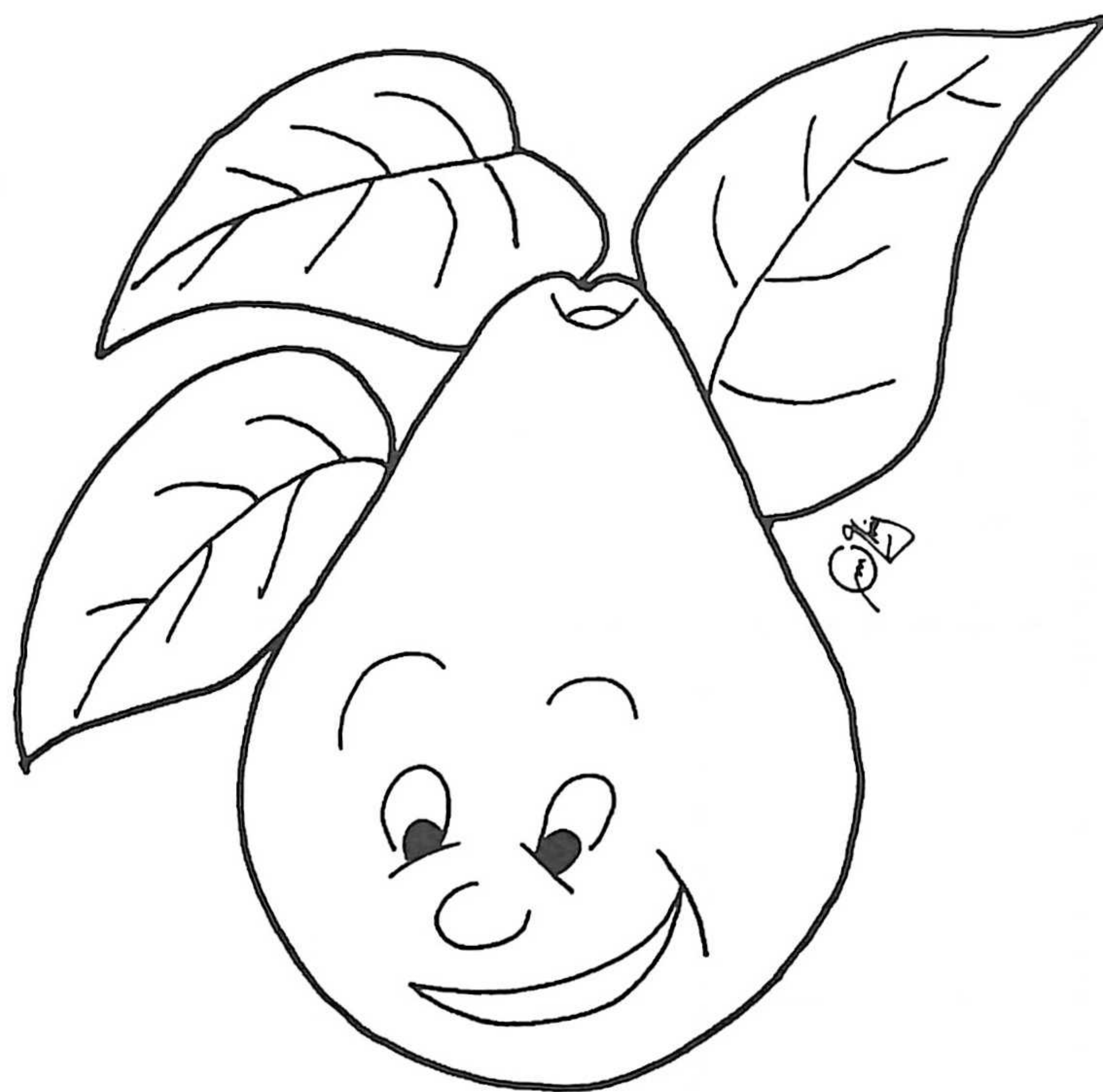

.. Ri tijonel nutz'loj chi kiwäch ri tijoxela', ri achike nuq'ajuj ri Janipe' kiwäch ri ch'akultz'ib' kik'wan ch'ut pa kiyonil chuqa' ri kaka' kik'wan ki'.
.. Ri tijonel nuya' re tz'eteb'äl e k'o, k'a ri nuya' q'ij chi ri tijoxela' nkikanoj ch'aaq chik tzij.



Ri B'i'aj



Ri b'i'aj ja ri', ri nya'o kib'i' ri winaqi', chikopi', juyu', konojel ri e k'o pa kajulew.

Tz'eteb'al

Kib'i' winaqi'	Kib'i' chikopi'	Kib'i' juyu' taq'aj	Kib'i' wachinäq	Kib'i' ri e k'o pa kaj
Ixmukane'	Tz'i'	Iximche'	Ch'atal	Ik'
Ixchel	Kej	Tz'olaj Ya'	Wuj	Ch'umil
Saqtekaw	Wakx	Pa Tz'i' Ya'	Tz'ib'ab'äl	Q'ij
Sipakna'	K'isik'	B'alam Ya'	Kematz'ib'	Kaq'iq'
Kaji' Imox	Äk'	Chi Xot	K'olaj	Jäb'

Keqakanoj ch'aaq chik b'i'aj pa jun sik'iwuj, k'a ri' yeqachär pa kik'ojlib'al.

Kib'i' winaqi'	Kib'i' chikopi'	Kib'i' juyu' taq'aj	Kib'i' wachinäq	Kib'i' ri e k'o pa kaj

- Ri tijonel nutziljoj achike nb'ek'ulun wi ri b'i'aj pa Kaqchikel Ch'ab'äl.
- K'a ri', nuya' ri tz'eteb'al e k'o chupam re ruxaq wuj re'.
- Tikirel nuya' sik'iwuj chi ke ri tijoxela', richin nkikanoj ri jalajöj b'i'aj nk'utux chi ke.



Solojsamaj pa ruwi' ri b'i'aj

Ke'akanoj chi awochoch jalajöj taq b'i'aj.

Kib'i' winaqi'	Kib'i' chikopi'	Kib'i' juyu' taq'aj	Kib'i' wachinäq	Kib'i' ri e k'o pa kaj

Tqab'ana kachib'äl e wo'o' b'i'aj.

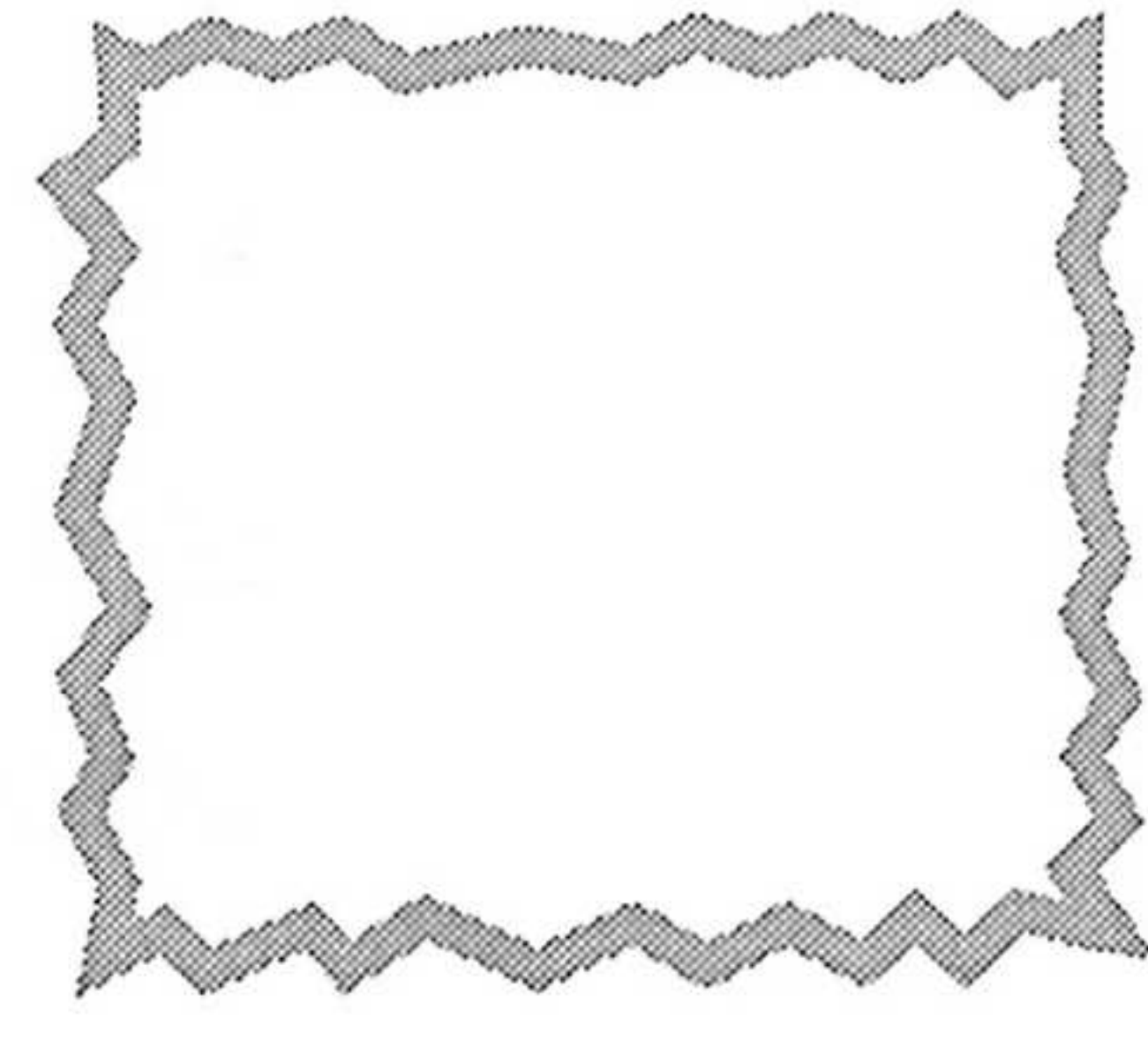
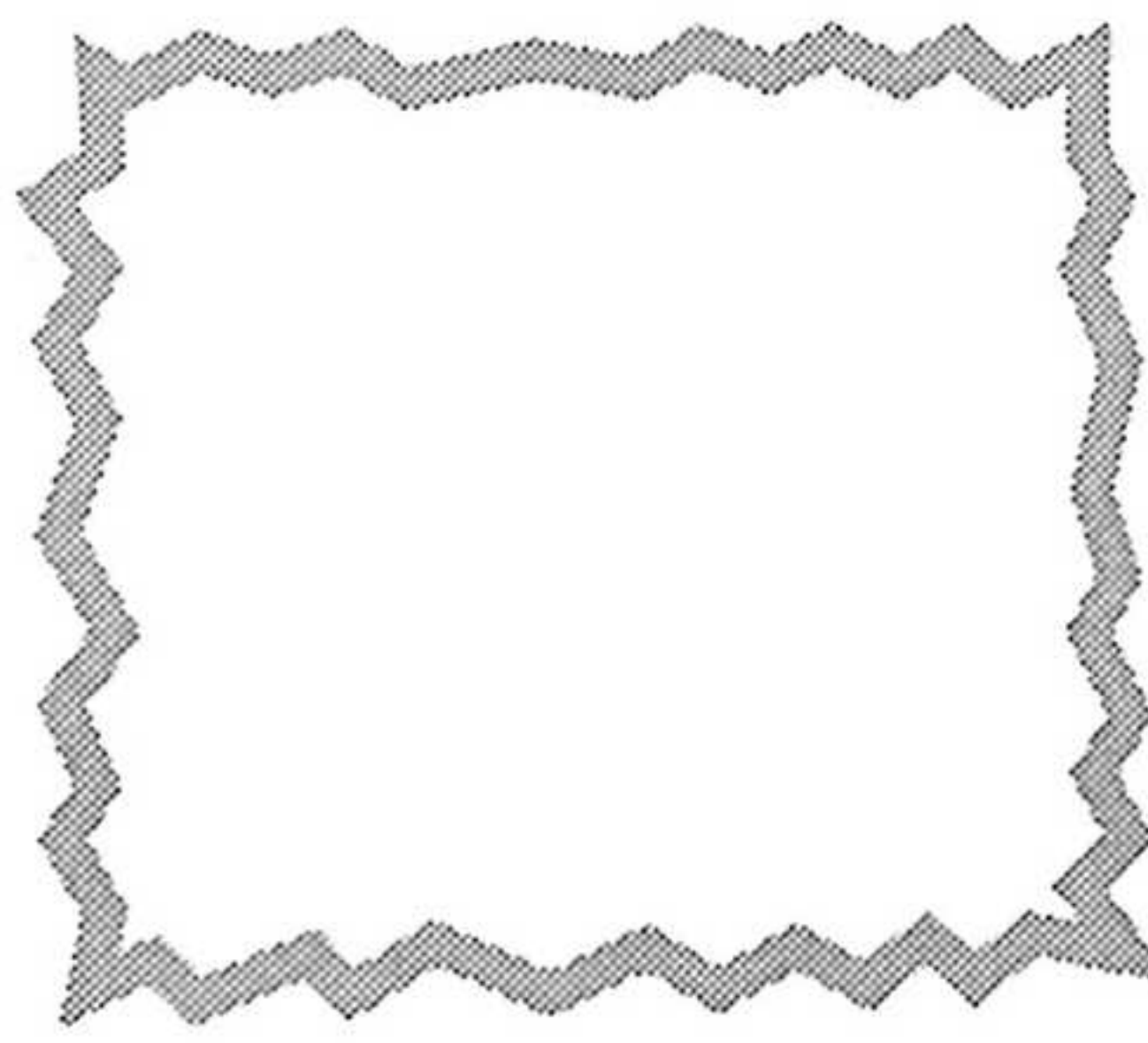
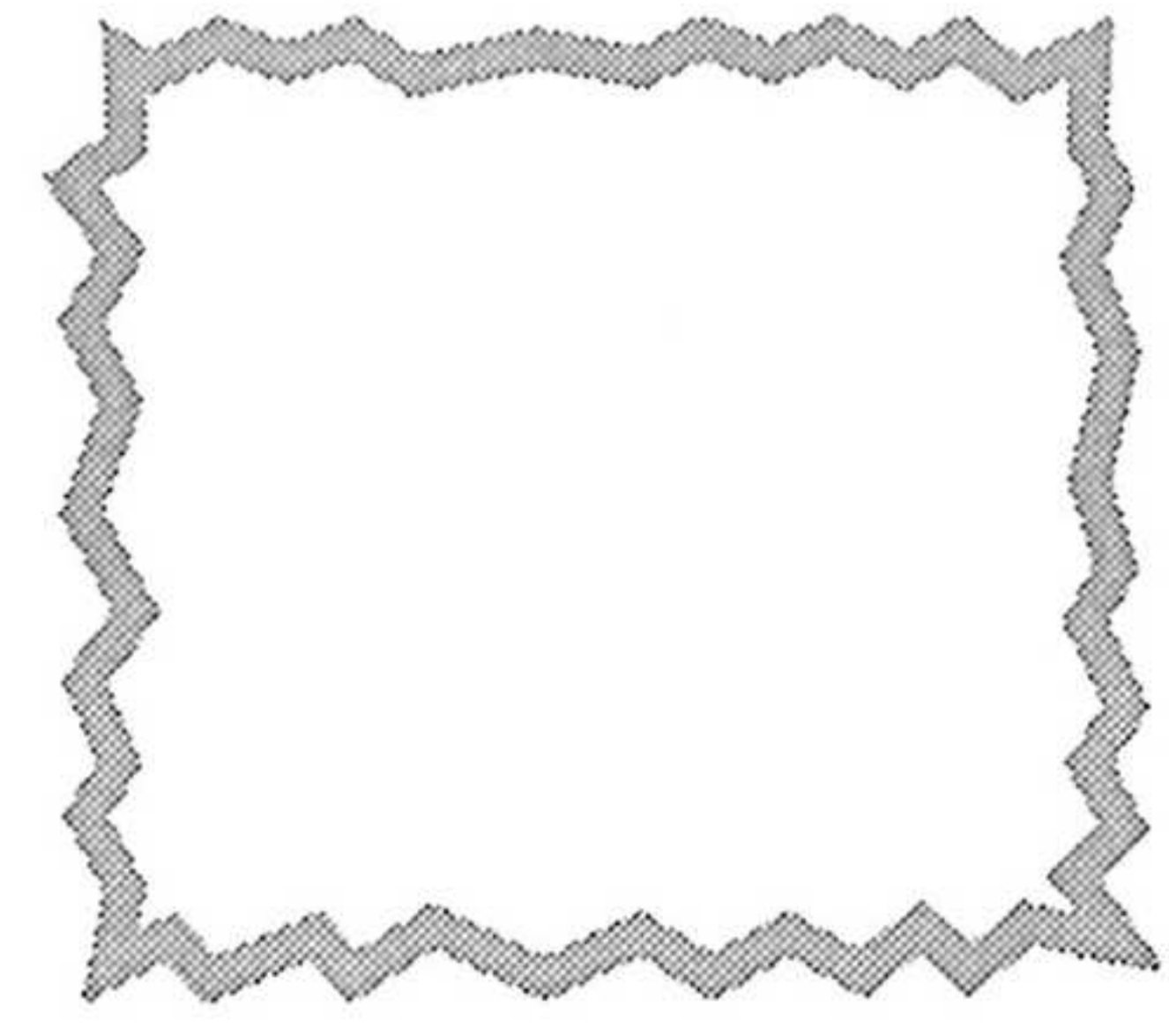
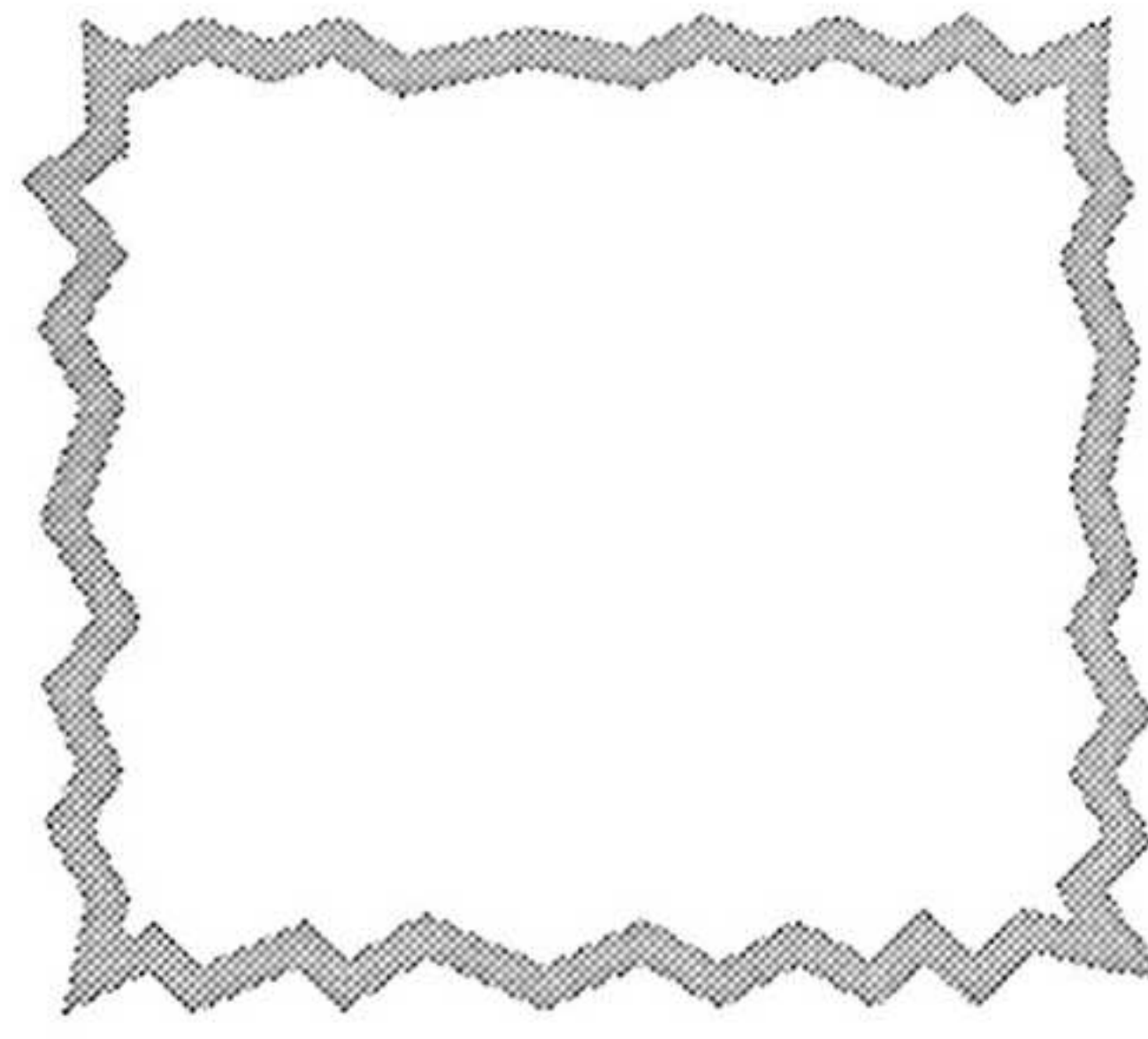
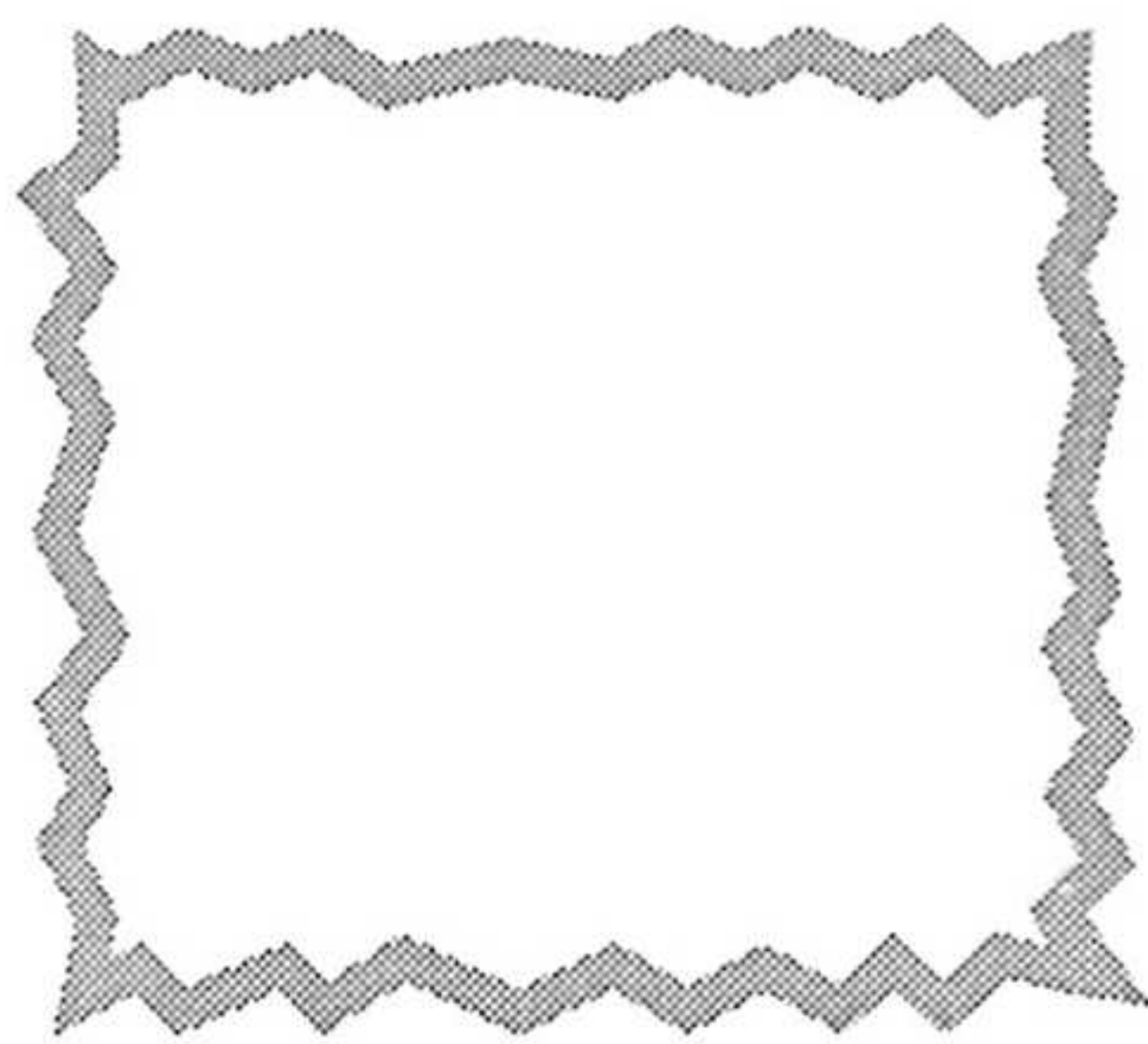

- Ri tijonela' nuya' el kismaj ri tijoxela' richin nkib'an pe chi kochoch.
- Ri tijoxela' nkitz'aqatirisaj ri kismaj rik'in ri achib'äl, k'o chi nkiya' rub'i'.

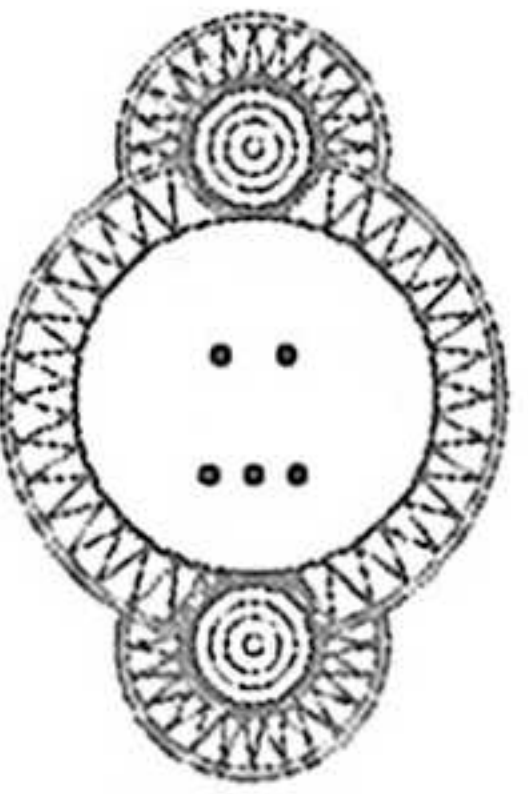

Rokisaxik ri Jalb'i'aj



Ri jalb'i'aj, ja ri', ri nujäl rub'anikil, rub'onil, rub'eyal, ch'aaq chik na'oj pa ruwi' ri b'i'aj. Re jalb'i'aj jantape' b'enäq chuwäch ri b'i'aj.

Chupam ri rutz'ib'axik ri Kaqchikel ch'ab'äl, yalan nïm rejqalem ri jalb'i'aj, ruma ja ri', nujalwachij ri b'i'aj. Pa ruwi' re tikirel yech'ar: wi ruma kiki'il, ruma kib'anikil, pa ruwi' kib'onil, pa ruwi' ch'aaq chik na'oj.

a) Pa ruwi' ri ki'il.

ch'äm ri q'enüm

k'äy ri aq'om

tzäy ri q'utun

poqon ri ik

b) Pa ruwi' ri kib'anikil

kotz'öl ri ak'wal

sotöl ri kumätz

xukül ri nan

pa'äl ri kej

k'ak'a' ri nuxajab'

d) Pa ruwi' kib'onil

qän ri ixim

käq rij ri jay

q'eq rij ri nutz'i'

säq ri kotz'i'j

- Ri tijonel nuya' chi kiwäch ri tijoxela', achike nb'ek'ulun wi ri jalb'i'aj.
- Re jujun tz'eteb'äl e k'o xa xe nk'atzin richin ri tijoxela' nketamaj ri rokisaxik ri jalb'i'aj.



Rokisaxik ri jalb'i'aj

Solojsamaj

Keqakanoj pa sik'iwuj, lajuj jalb'i'aj,
k'a ri' yeqokisaj pa q'aptzij.

Jalb'i'aj

q'aptzij

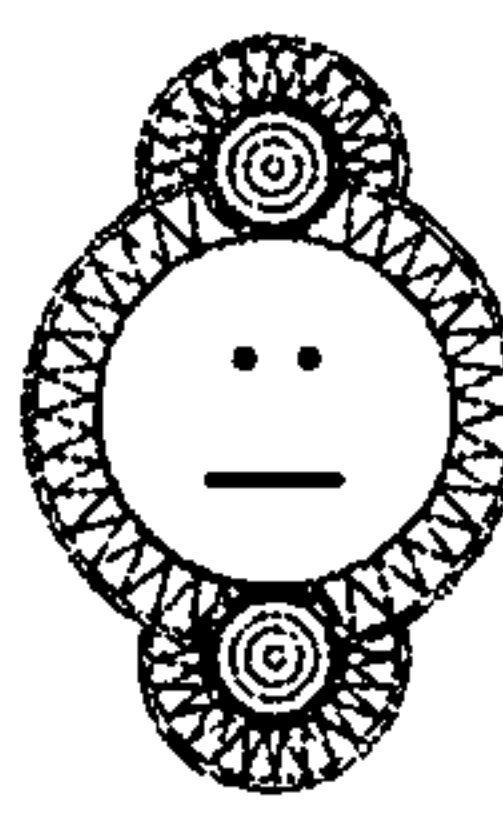

Tqab'ana kachib'äl wo'o' jalb'i'aj.

Tz'eteb'äl: Sotöl ri kumätz, kotz'öl ri ala', xukül ri nan, xar ri yakb'äl q'ayis, säq wuj.

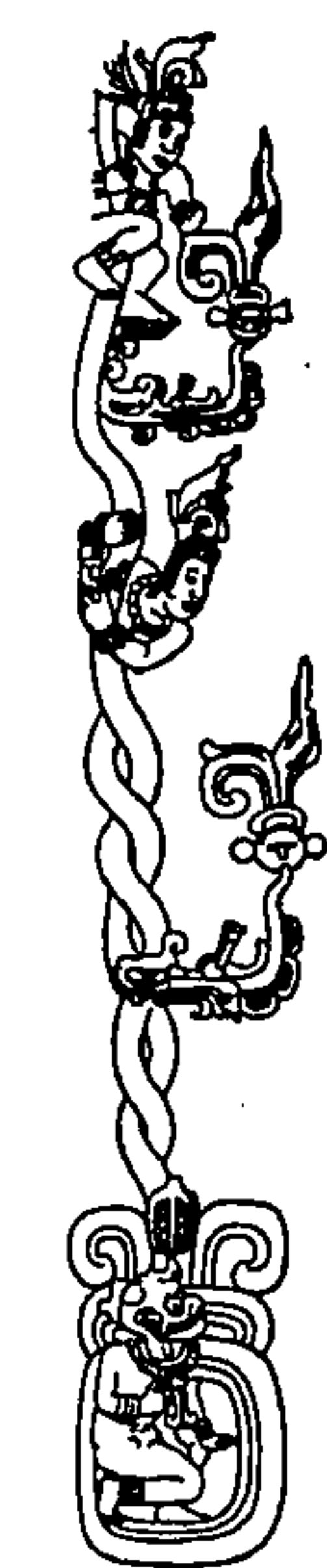

.. Ri tñonel nuk'äm pe jalajöj sik'iwuj chuqa' taluwuj richin ri tijoxela' nklkanoj ri jalb'i'aj.
.. Ri tñonel k'o chi nutzijoj chi ke ri tijoxela' achike ri' ri jun kokoj na'oj.

Kiq'ij kejqalem winaqi'



Nan,	tat,
ixtän,	ala'
ya,	ma,
	a

Richin nqaya' kejqalem winaqi', nqokisaj jun cholaj tzij ja ri' yeqokisaj töq yojch'o apo chi re jun winäq, nqokisaj töq man qetaman ta rub'i' chuqa' töq xa xe yojch'o apo chi rij.

Keqokisaj pa rub'eyal re jujun kiq'ij kejqalem ri winaqi'.

Tetata': Ja re' nb'ix chi ke ri winaqi' k'o chik k'iy kijuna'.

Nan: Nqab'ij chi re jun nimawinäq ixöq.

Tat: Nqab'ij chi re jun nimawinäq achi.

ya: Nqokisaj chuwäch rub'i' jun ixöq, töq k'ulan chik chuqa' richin nqaya' ruq'ij.

Ma: Nqokisaj chuwäch rub'i' jun achi töq k'ulan chik, chuqa' richin nqaya' ruq'ij.

Ixta: Nqokisaj chuwäch rub'i' jun q'opoj.

a. Nqokisaj chuwäch rub'i' jun ko'öl ala'.

Katz'inel nqak'utuj chi ke ri winaqi', achike rub'eyal nkokisaj re kiq'ij kejqalem winaqi' pa ach'alalri'il

- Ri tijonel nuya' chi kiwäch ri tijoxela' achike nuq'ajuj ri kik'ojlemal ri winaqi'.
- Ri tijoxela' nkisik'ij achike ntzijox chi rij ri kiq'ij kejqalem ri winaqi'.
- Ri tijoxela' nkitz'ib'aj kina'oj pa ruwi' ri k'utunik.



Tqatz'ib'aj jun tzijonem akuchi nqokisaj ri kiq'ij kejqalem winaqi'.

A large rectangular box with horizontal lines for writing, containing a drawing of a pencil in the bottom right corner.



Pa maya' na'oj, yalan nim rejqalem ri nya'ox kiq'ij kejqalem winaqi', ruma rik'in re' yojtikir nqaya pa rub'eyal ri qatzij, ke chuqa' ri' nqaya' pa rub'eyal ri kejqalem konojel winaqi'.

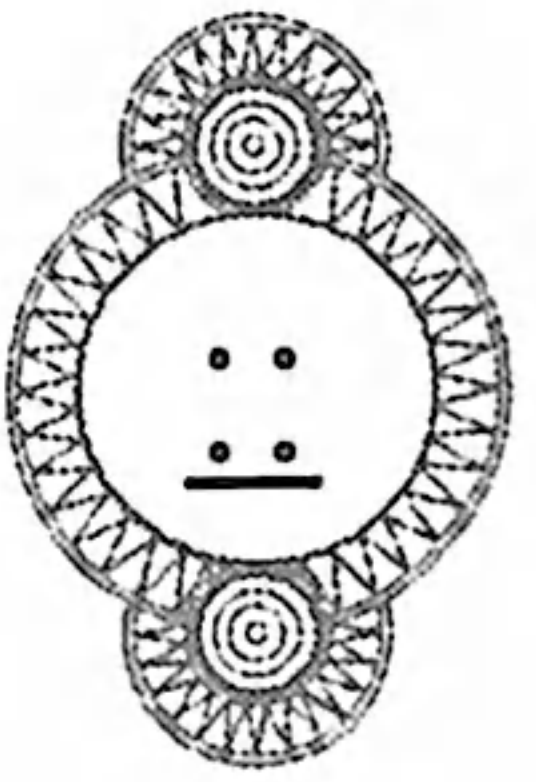

Tqak'utuj chi ke ri qate' qatata', we k'a e k'o na ch'aqa chik rub'eyal nya'ox ri kiq'i'j kejqalem winaqi' chuqa' akuchi tikirel ye'okisax wi.

A second large rectangular box with horizontal lines for writing, containing a drawing of a pencil in the bottom right corner.



- Ri tijonel nuya' rutz'aqat ri na'oj pa kiwi' ri kik'ojlemal ri winaqi'.
- Ri tijoxela' nkitz'ib'aj ri jun kitzijonem, akuchi nkiya' kiq'ij kejqalem winaqi'.

Rokisaxik ri ichinanel b'i'aj



Ja ri' jun rutz' aqat tzij jantape' b'enäq chuwäch
ruxe'el jun b'i'aj.

Richin jun b'i'aj, kan e k'o na wi ri taq
rutz' aqat tzij yerokisaj; we ntz' ukutäj el
rik'in k'uxatz'ib', we ntz' ukutäj el rik'in
ch'akultz'ib'.

Tz'eteb'äl:

Töq ntz' ukutäj el rik'in k'uxatz'ib'.

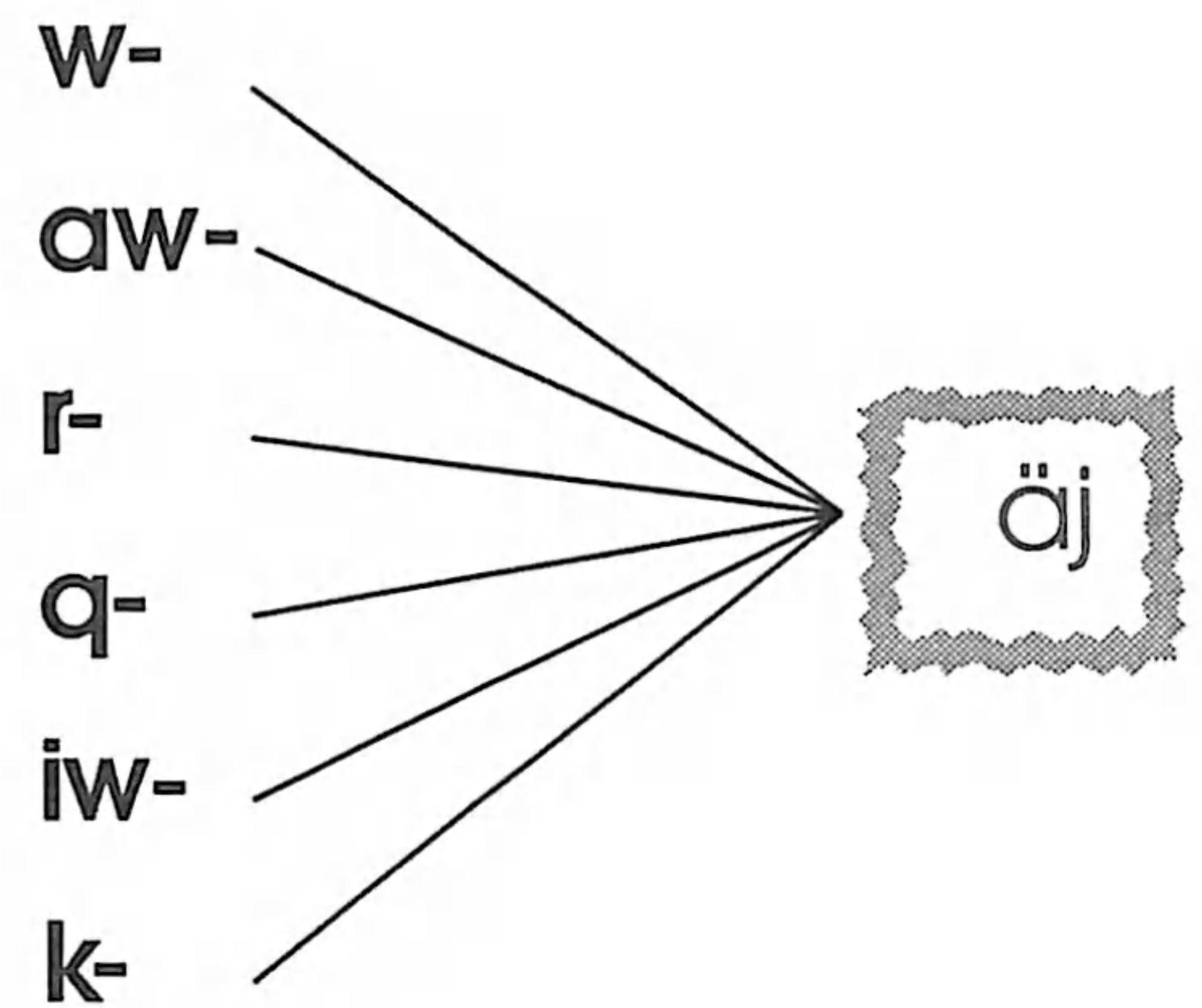
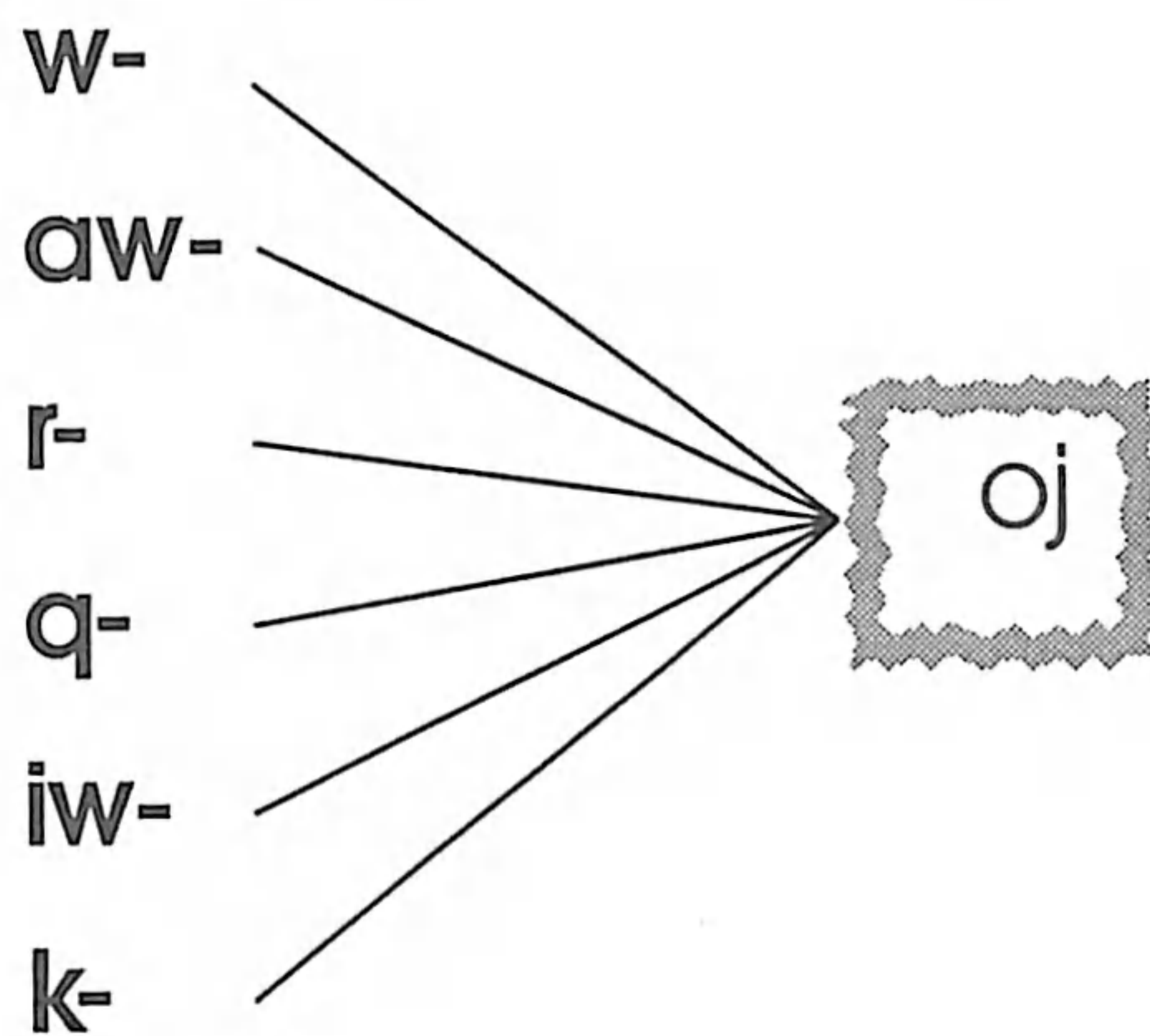

Töq ri tzij ntz' ukutäj el rik'in ch'akultz'ib'.

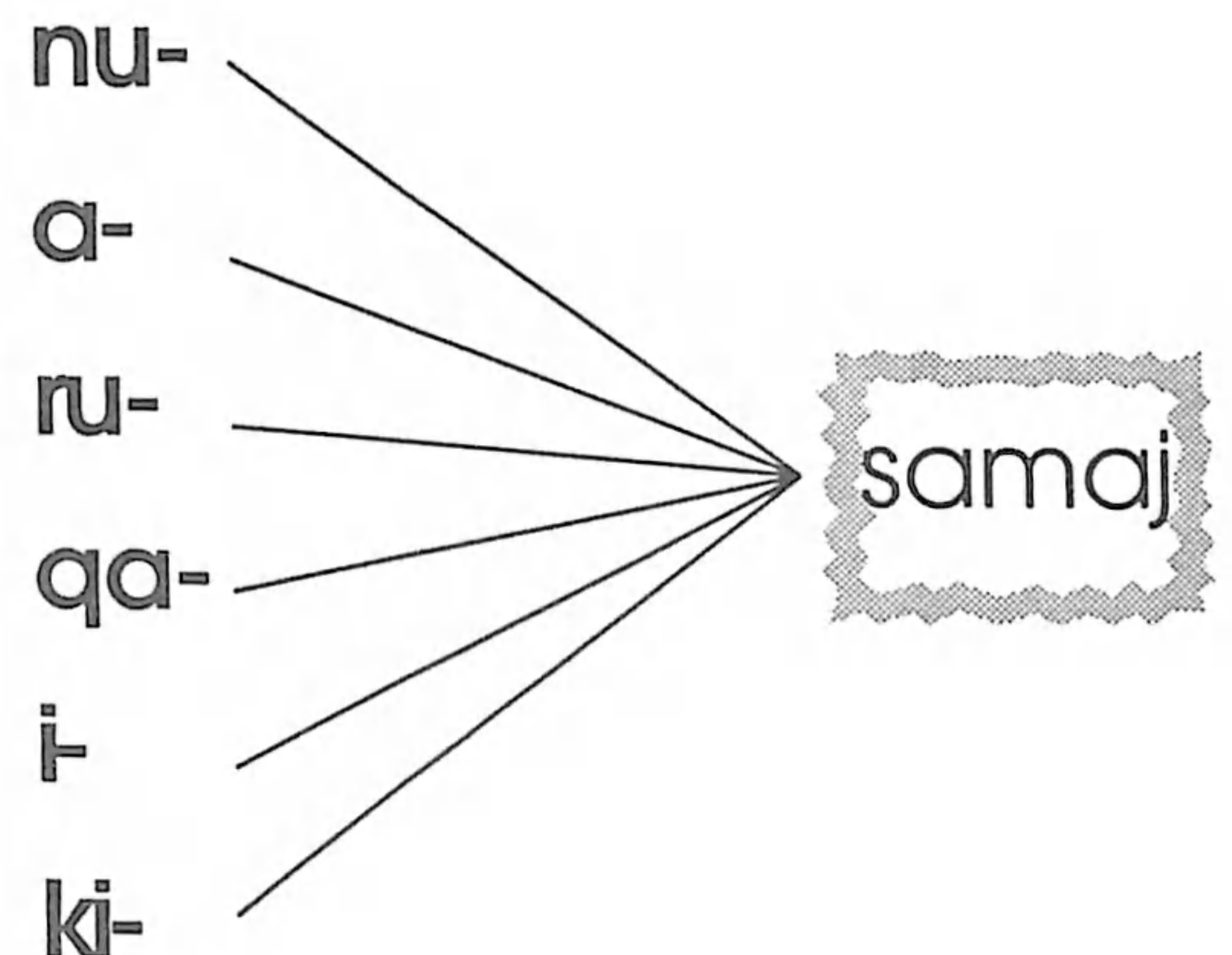
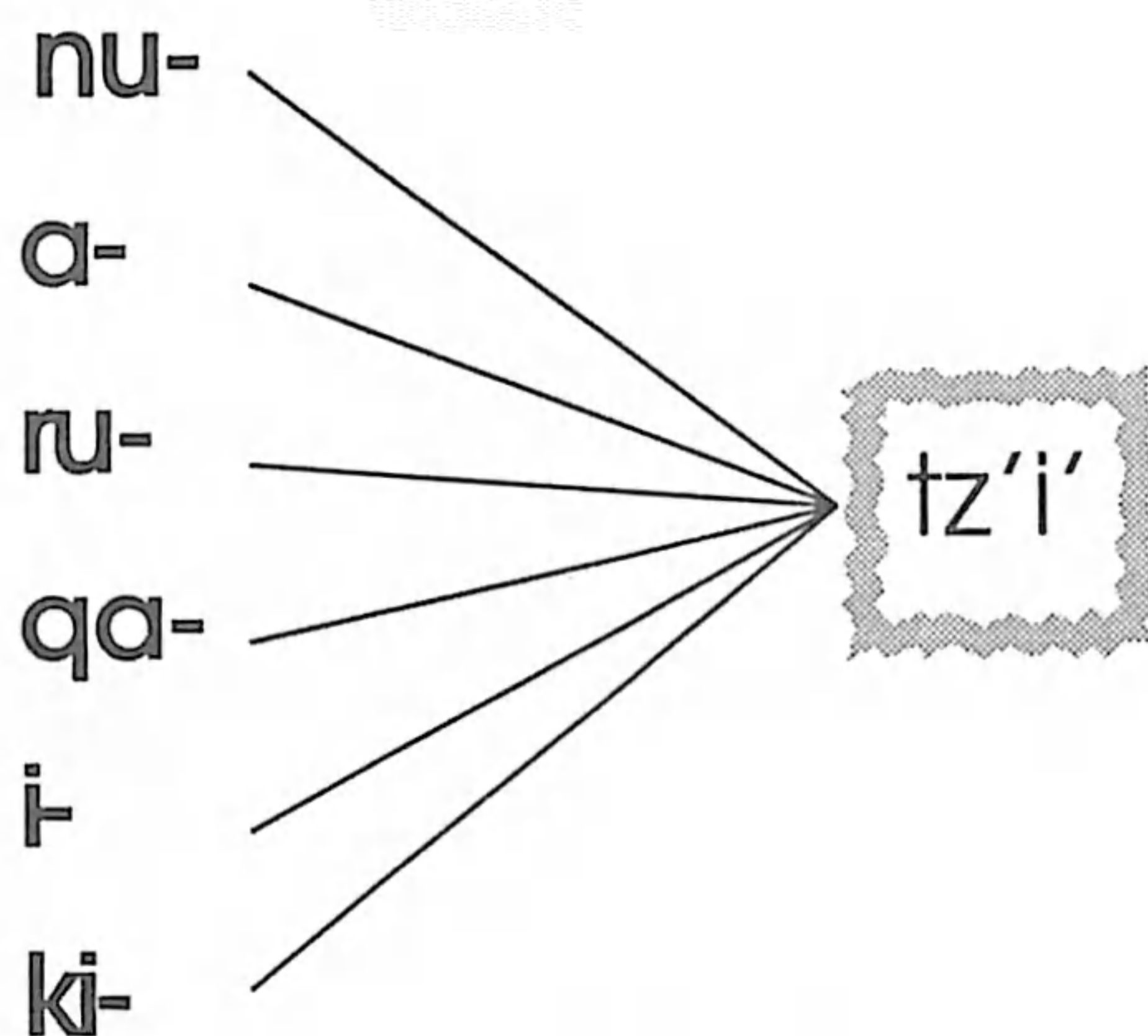

- Ri tijonel nuya' rutz' aqat ri na'oj pa ruwi' ri ichinanel b'i'aj.
- Ri tijoxela' jeb'ël nkitz'ët ri rokisaxik ri ichinanel b'i'aj.
- Tikirel nb'an jujun tz'eteb'äl richin njlkib'äx kan ri etamab'äl.



SAMAJ

1. Tqatz'ib'aj jun ti q'olaj akuchi nqokisaj wi ri ichinanel b'i'aj.

A large rectangular box with a wavy top edge and a folded bottom-right corner. Inside, there are seven horizontal lines for writing. A pencil icon is positioned in the upper right corner of the box.



2. Ri taq kajtzij nuk'waj jun ichinanel b'i'aj jantape' kijachon ki'

Ja manaq

3. Ri ichinanel b'i'aj nkich'är ki' pa ka'i':

Ja manaq

4. Tqasik'ij re jun ka'i' oxi' na'oj re':



1. Töq yojtz'ib'an pa qach'ab'älk'ochi nab'ey yojq'ijun pa qana'oj.
2. Man tikirel ta nawichinaj kamul jun b'iaj.



• Ri tijonel nuto' ri tijoxel richin rutz'ukik jun ti q'olaj.
•• Ri tijonel nuya' ri rub'eyal richin nb'an la ruka'n samaj.
••• Ri tijoxel nusik'ij re ruk'isib'äl ti samaj, re rub'eyal nokisäx ri ichinanel b'i'aj.

Tqak'utu ri Xqetamaj



1 Keqatz'ib'aj achike ri', ri ch'ach'el k'uxatz'ib':

2 Keqatz'ib'aj achike ri', ri latz' k'uxatz'ib':

3 Tqatz'ib'aj achike kib'i' re ch'akultz'ib' re':

b', k', q', t', ch', tz'. _____

4 Tqatz'ib'aj kib'i' re jujun b'i'aj re':

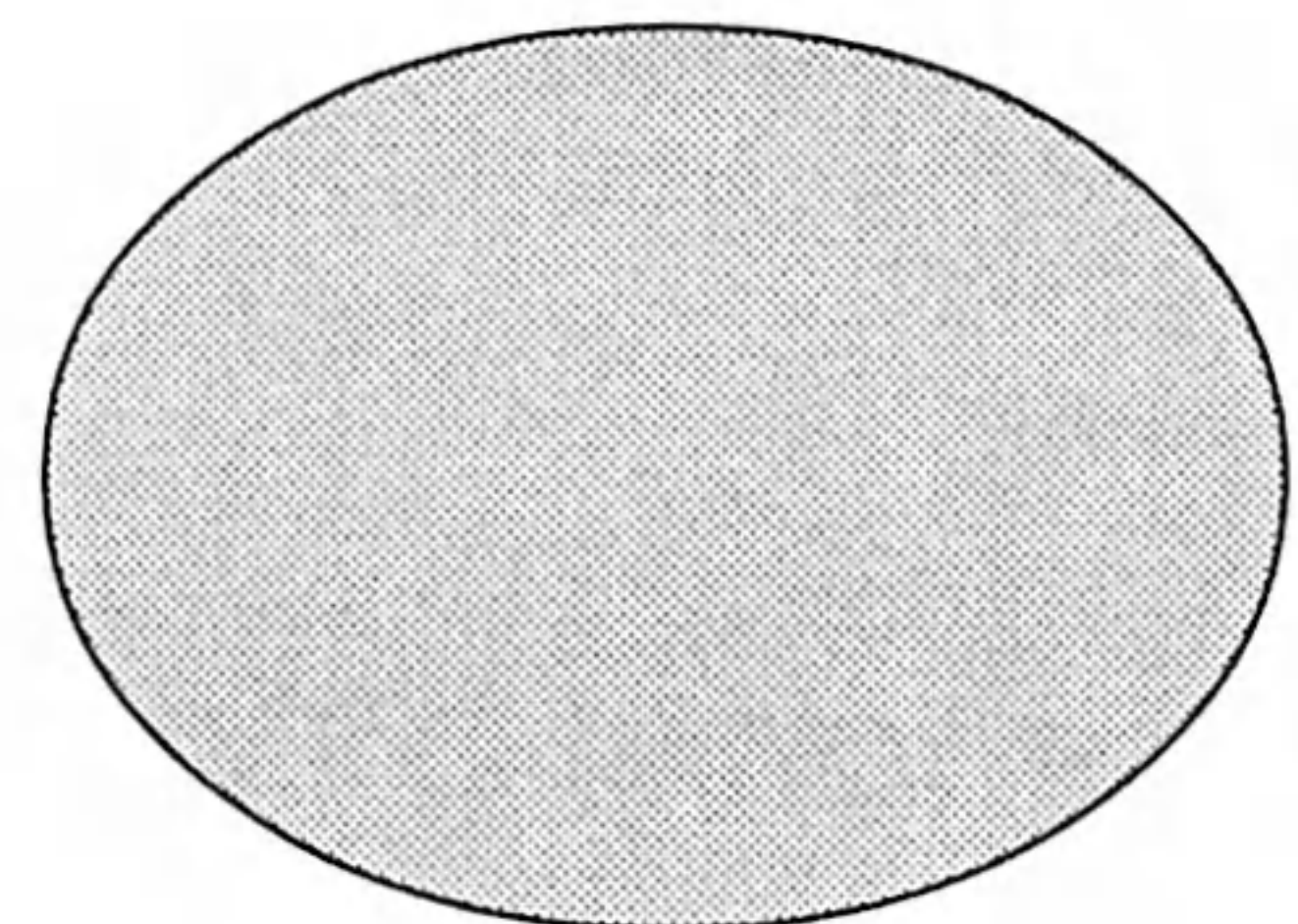
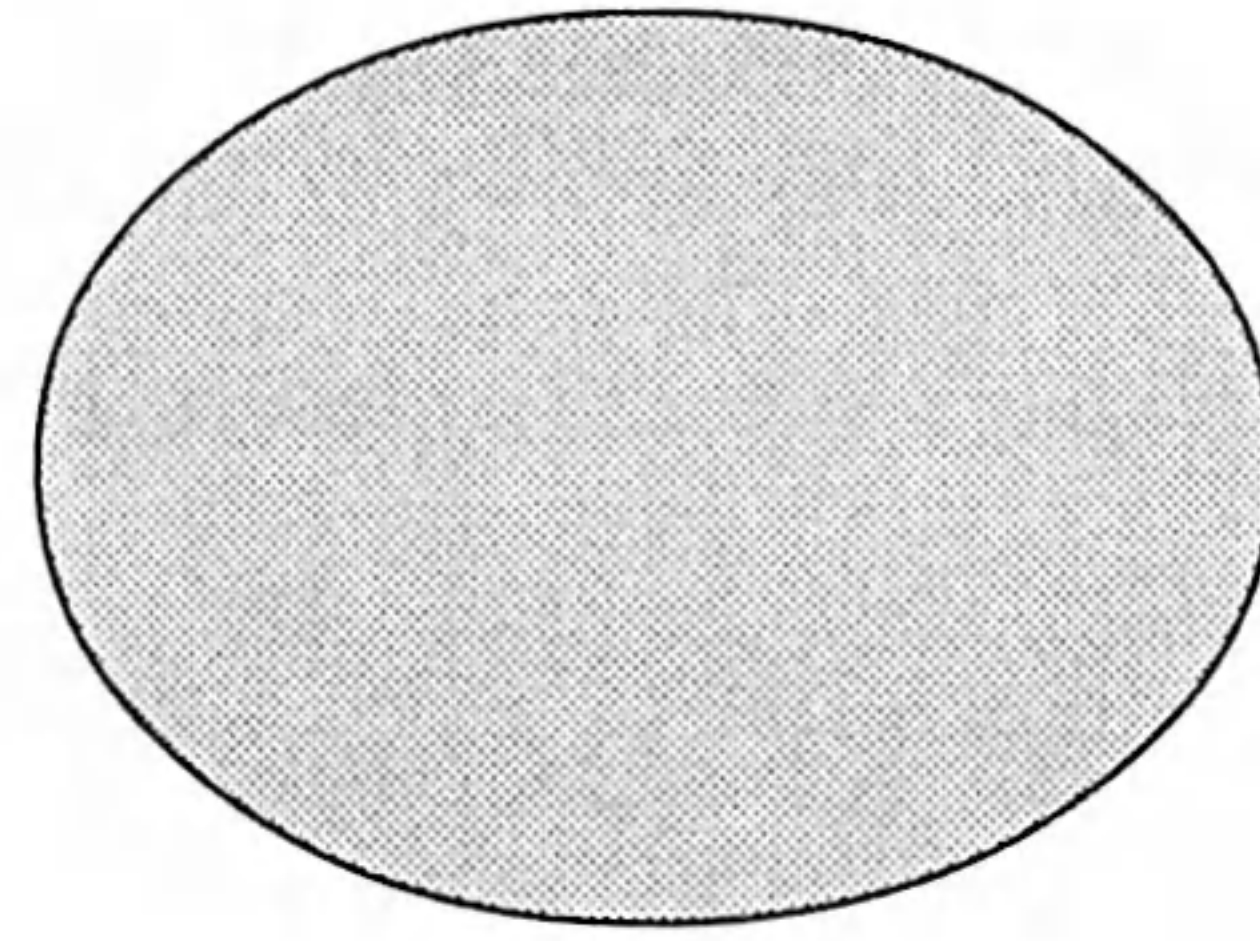
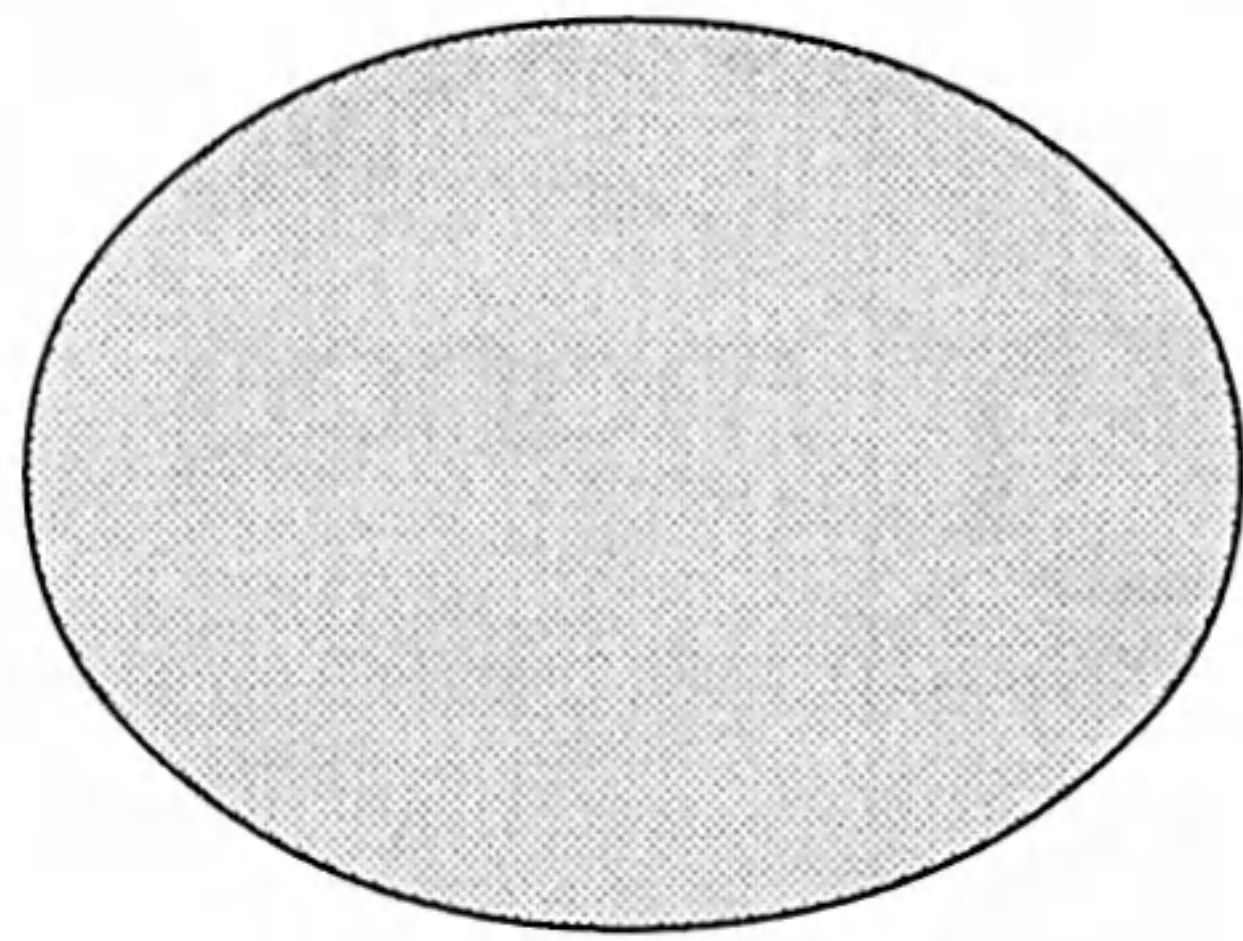

5 Achike kib'i' re jun molaj tzij re re',

nan, tat, ixtän, ma, ya, a _____

6 Tatz'ib'aj ri k'ajtzij nrokisaj ri ichinanel b'i'aj ntz'ukutäj el rik'in k'uxatz'ib'.

7. Jantape' yeqatun ri k'ajtzij rik'in ri b'i'aj.

Ja'

manaq

- Ri tijonel k'o chi mani yeruxib'ij ri ak'wala', rik'in re jun ti samaj re'.
- Ri tijonel xa xe yeruto' ri tijoxela' we k'o jun nkik'utuj.

RUKAJ TANAJ

Rejqalem ri ach'alalri'il



Ri etamanik nuq'i' ri tijoxel:

Nuya' rejqalem ri ach'alalri'il.
Nutzijoj ri rejqalem ri ach'alalri'il pa maya' na'oj.
Nub'ixaj jun b'ix wach'alal rub'i'.
Ntz'ib'an pa ruwi' ri kamelanik.

Rejqalem ri Ach'alalri'il



Tqatzijoj pa molaj ri rejqalem ri ach'alalri'il, k'a ri' ri xqatzijoj k'o chi nqatz'ib'aj pa ruwi' taq juch'.Tqab'ana



Handwriting practice lines consisting of five horizontal lines with a dashed midline.

Tqab'ana' kachib'al ri qach'alal, nqaya' retal akuchi öj k'o wi röj

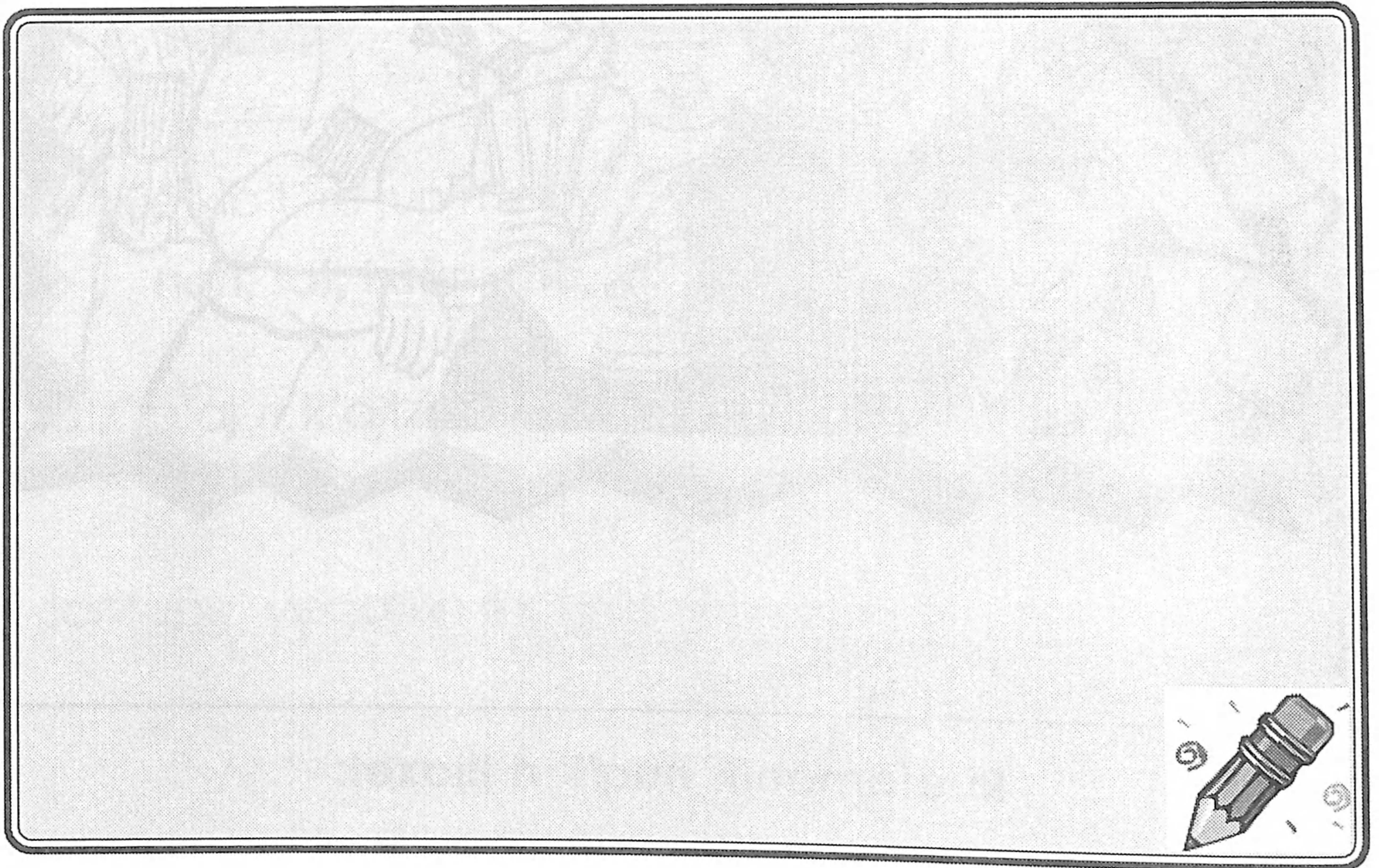

- Ri tijonel yerunuk' pa taq molaj ri tijoxela' richin nkib'an ri nab'ey kisamaj
- Ri tijoxela' k'o chi nkib'onij ri achib'al xkib'an.



Ri We'aman

Rejqalem ri nqanimaj kitzij ri qate' qatata'

Tqatzib'aj jun pixa' kiya'on ri qate' qatata' qach'alal chi qe.

Four horizontal lines for handwriting practice.

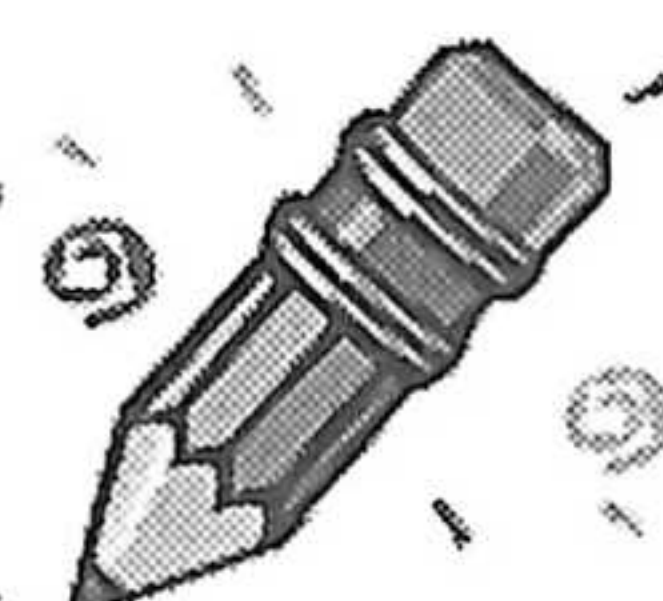

Ri jun pixa',
ja ri' ri kina'oj
nkiya' ri te'ej
tata'aj chi ke ri
kalk'wal.



Pa ruwi' re pixa' re' tqatz'uku' jun ti b'ix.

A large empty rectangular box for drawing or writing.

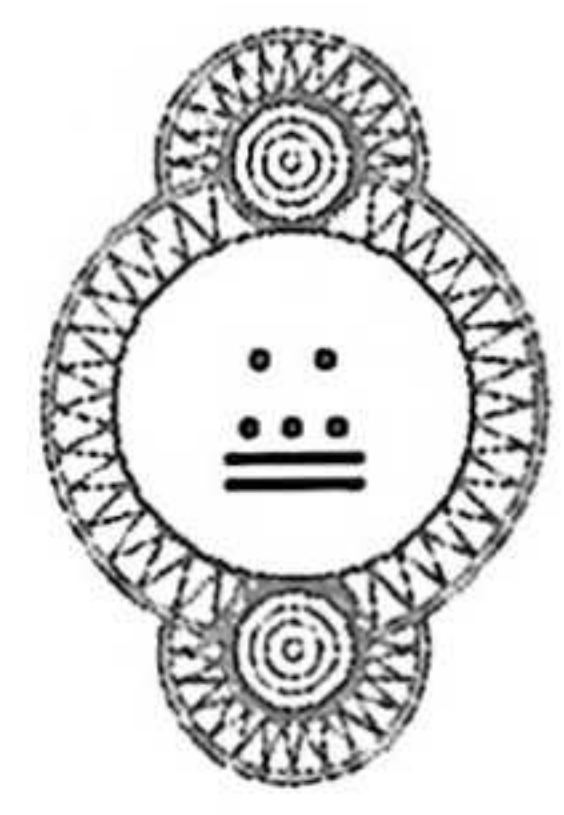

Tqatzijoj chi ke ri qach'alal ri rub'eyal xqanuk' re jun b'ix.



- Ri tijonel nutzijoj chi ke ri ak'wala' achike ri jun pixa', richin ke ri' yeruto' ri ak'wala'.
- Utz ta nkib'an jun b'ix konojel ri ak'wala'.



Na'oj pa ruwi' ri b'ix wach'alal rub'i'



Pa molaj tqab'ixaj re jun b'ix re'.

RI WACH'ALAL.

La ra la, la ra la la, la ra la ra la,
la ra la, la ra la la, la ra la ra la,
la ra la, la ra la la, la ra la ra la
la ra la ra la.

Ri nuchaq' yalan yesamäj
rik'in ri nutata',
ri wana' jeb'ël nb'ixan
chuchi' ri q'aaq',
nutata' yalan nkikot
rik'in ri ruk'aslem;
rik'in ri ruk'aslem.

Ruk'u'x ri b'ix

RUMA RI', YALAN YIKIKOT,
YALAN YIKIKOT,
KIK'IN RI WACH'ALAL;
RUMA RI', YALAN YIKIKOT,
YALAN YIKIKOT,
KIK'IN RI WACH'ALAL;
KIK'IN RI WACH'ALAL.

Numama', nuya' ri pixa'
chi ke riy rumam,
ri wati't nutzijoj xajanil
chi qe qonojel
ri nute' nupon ri qaway
nqak'waj pa samaj;
nqak'waj pa samaj.

Ruk'ux ri b'ix

K'atzinel chi röj qach'alal,
yojsamäj junam,
kixuxlan k'a ri wach'alal,
ruma xixkos,
xe jub'a, xinch'o chi rij
ri ach'alalri'il;
ri ach'alalri'il.

Tz'ib'anel chuqa' ya'öy ruq'ojom:
Tijonel, Armando Loch Mayor.
Tijob'äl: EORM, Aldea la Cruz
Tinamit: Aldea la Cruz, San Pedro
Yepocapa, Chimaltenango.

Tqatz'ib'aj ri na'oj xuya' kan re jun b'ix re' chi qe.

- Ri tijonel k'o chi jeb'ël retaman re jun b'ix re'. Tikirel nrokisaj ri jun samaj pa ruwi' b'ix kib'anon ri Kaqchikel Moloj, chuqa' ri Kaqchikel Cholchi'.
- Tikirel nkitijoj ki' pa faq kokoj molaj, k'a ri pa nimamoloj.
- Töq k'o jun nimaq'ij pa tijob'äl üt'z yeb'ixan ri ak'wala'.





Ri kisamaj ri qach'alal

Keqaqupij kachib'äl ri samaj nkib'än ri qach'alal. Töq e k'o chik, yeqatz'arab'a' chupam ri jun kajtz'uk.



Tqatz'ib'aj wawe' ri kib'i', achike samaj yekib'än ri qach'alal.



Ri tijoxela' fikirel nkiqupij pa taq taluwuj ri kachib'äl ri samaj nkib'än ri kach'alal.

Jun Lema' pa ruwi' ri ach'alalri'il

Tqanuk'u' jun lema' pa ruwi' ri ach'alalri'il.



Blank writing area with horizontal lines and a pencil icon at the bottom right.

Lema'

Ri jun lema' ja ri' ri nkitzijoj ri qate' qatata' pa ruwi' ri kiq'axan pe kik'ulwachin pe pa kik'aslem.



Tqak'utuj pe jun lema' kik'in qach'alal. Tqatz'ib'aj wawe'.

Blank writing area with horizontal lines and a pencil icon at the bottom right.



- Ri tijonel k'o chi nutzijoj achike ri' ri jun lema'.
- Tikirel xa xe jun ka'i' oxi' kina'oj nkiya' pe ri ak'wala'.

Achike ruma k'o chi Yojkamelan

Ri kamelanik jun b'anob'al k'o chi nqab'an pa qak'aslem richin nqaya' k'iq'ij ri qate' qatata' chuqa' ronojel ri k'o chuwäch ri loq'oläj kajulew.



Tqatz'ib'aj achike rub'eyal yekamelan ri qach'alal. Tqatz'ib'aj chuwäch re qasik'iwuj chuqa' chuwäch per wuj richin nqatz'arab'a' chuwäch xan pa qochoch.

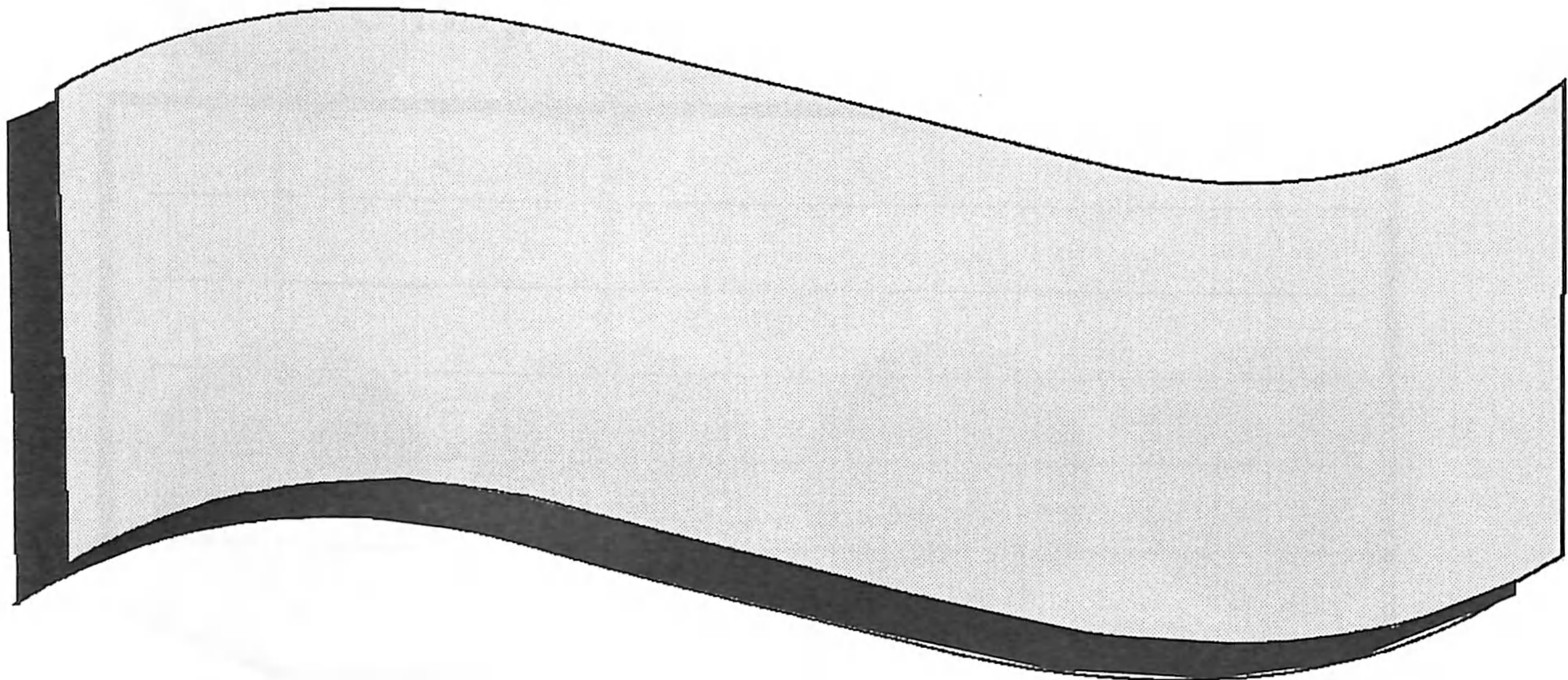

- . Ri tijoxela' nkisik'ij ri jun ti na'oj pa ruwi' ri kamelanik.
- .. Ri tijoxela' nkitz'ib'aj chuwäch kiwuj, k'a ri' nkitz'ajb'a' chuwäch ri xan.



Rub'eyal ri Kamelanik



Tqatz'eta' ri jujun rub'eyal richin yojkamelan.
Kojch'ob'on.

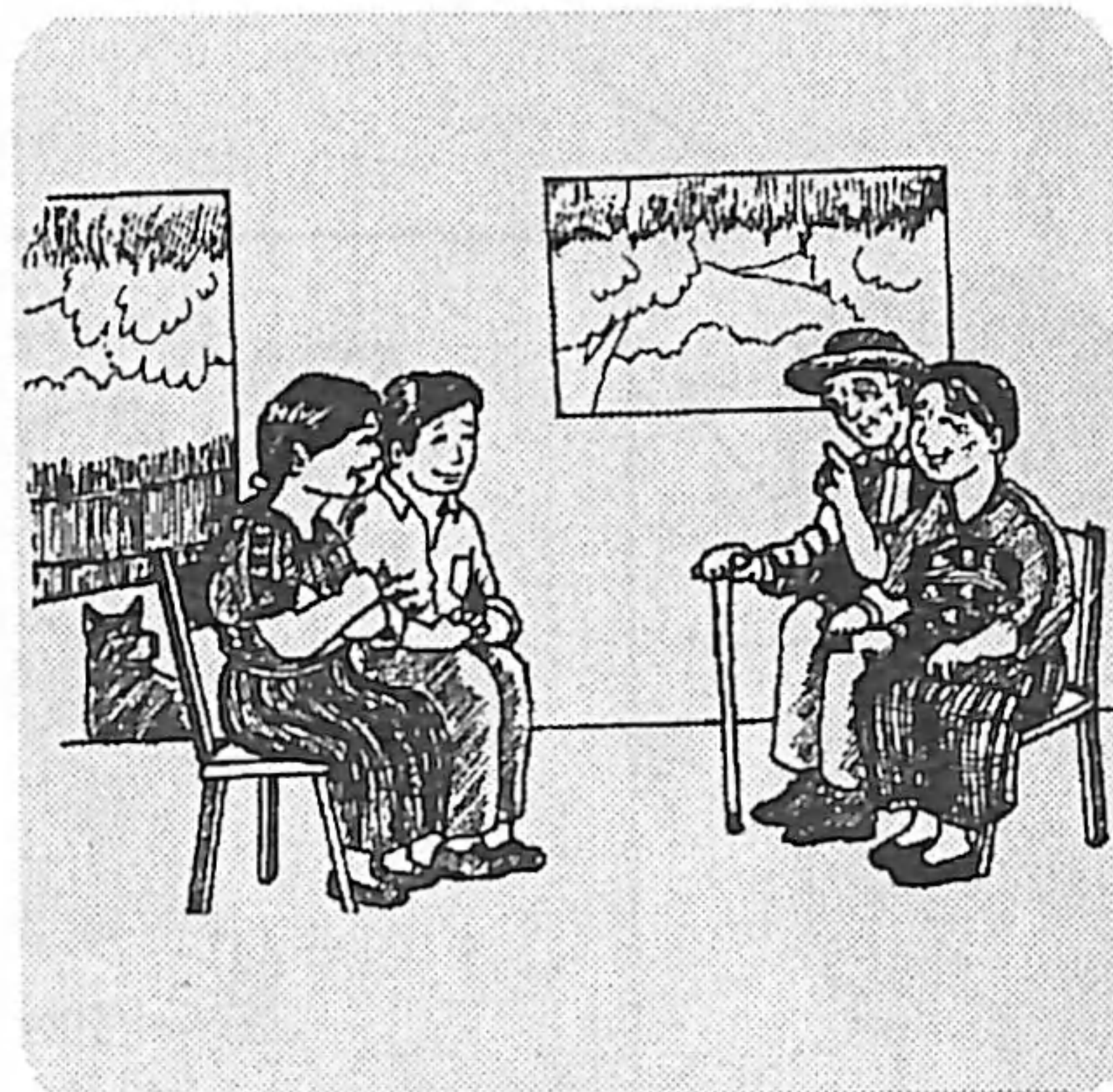

Tqatz'ib'aj wo'o' b'ab' pa kiwi' ri jujun taq achib'äl.



Blank writing area with horizontal lines.

- Ri tijonel nuya' q'ij chi ri tijoxela' nkisik'ij ri jun ti na'oj pa ruwi' ri kamelanik.
- Ri tijoxela' nkitz'ib'aj chuwäch kiwuj, k'a ri' nkitz'ajb'a' chuwäch ri xan.



Tqatz'ib'aj kib'i' ri winaqi' e k'o chi kikojol ri ach'alri'il, chi kipam ri taq setesäq.

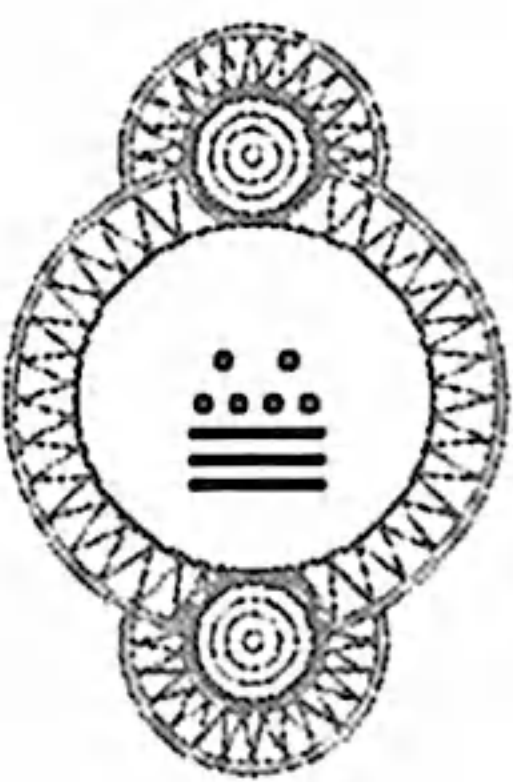
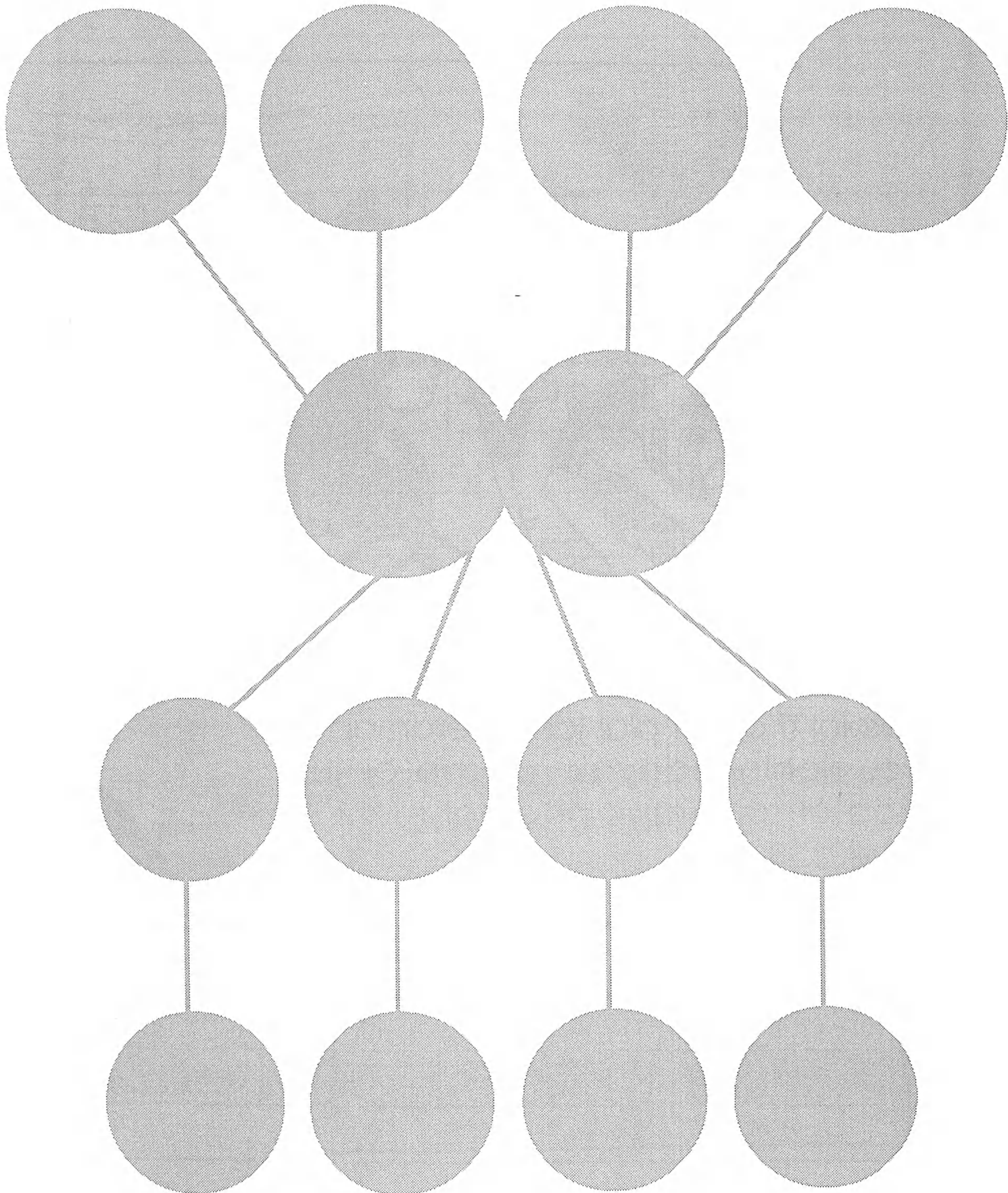

• Ri tijonel nuya' q'ij chi ri tijoxela' nkisik'ij ri jun ti na'oj pa ruwi' ri kamelanik.
•• Ri tijoxela' nkitz'ib'aj chuwäch kiwuj, k'a ri' nkitz'ajb'a' chuwäch ri xan.

Ri ach'alalri'il pa jun tinamit



Pa maya' na'oj qonojel qach'alal qi',
ruma ri' rajowaxik chi nqato' qi' pa ronojel
samaj ke chuqa' ri' pa ruwi' na'oj.

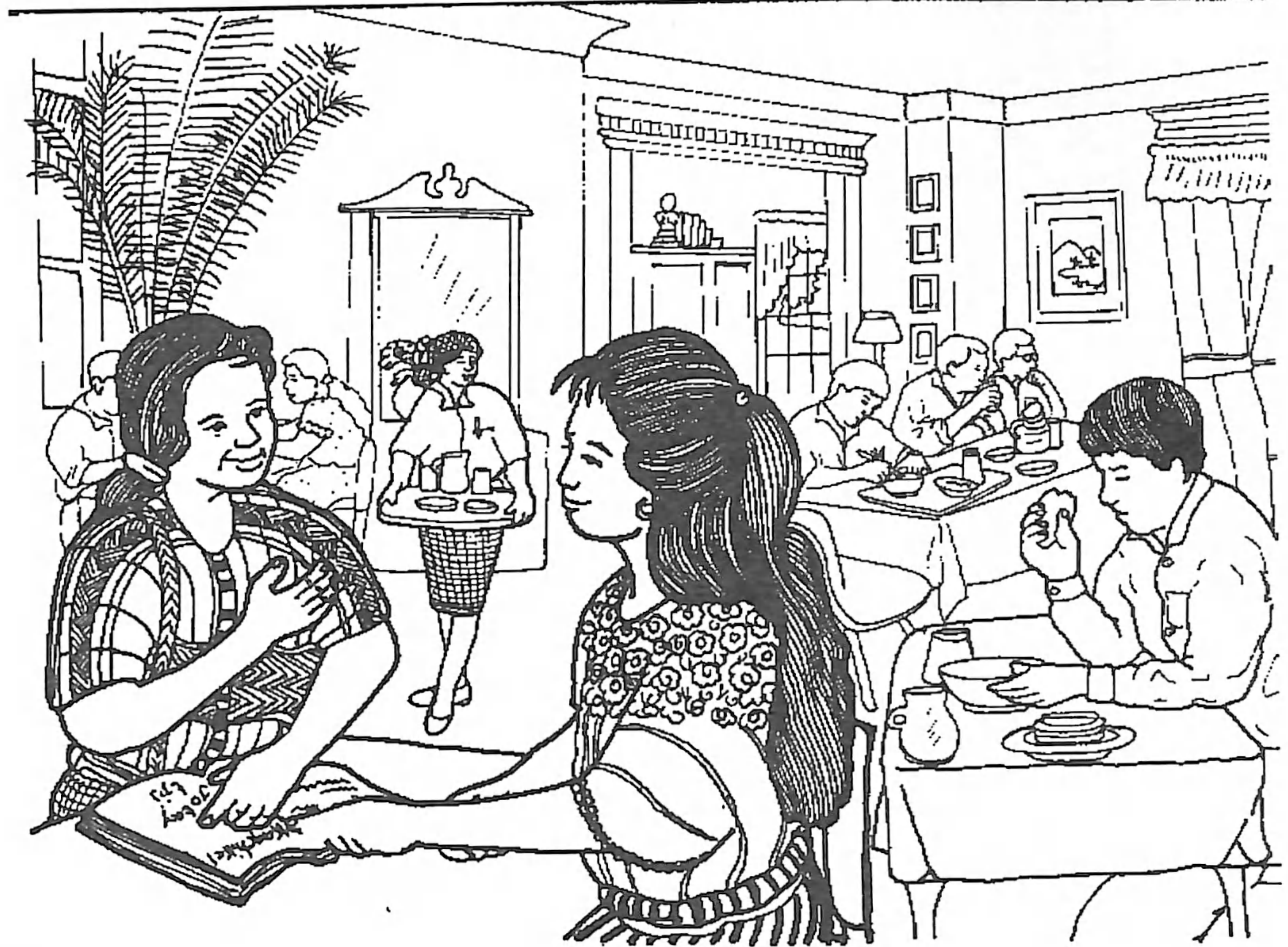

Chi kikojol ri qach'alal jalajöj etamab'äl
e k'o, richin nqayäk jun na'oj jun
b'anob'äl rajowaxik nqamol ruchi' ri
qana'oj.



Blank writing area with four horizontal lines.

Ri tijonel yerukem ri ka'i' na'oj richin nunimirisaj ri ketamab'al ri tijoxela'.



Tqach'ob'o tqatz'ib'aj pa molaj, achike ta rub'eyal richin ri ach'alalri'il yeto'on pa qatinamit.

Large empty rectangular box with three horizontal lines for writing.

Richin nqayäk ri qatinamit, achike k'o chi nqabän.

Large empty rectangular box with four horizontal lines for writing, featuring a faint pencil illustration on the left side.

E ja re'
rusamaj
ri jun utziläj
ach'alalri'il

Nkito' ki' pa ruwi' kisamaj
Yech'ob'on pa ruwi' kitinamit
Ri te'ej tata'aj yekimol ri kalk'wal
Ri alk'walaxela' nkinimaj kitzij ri kite'
kitata'

• Ri Iijonel yerunuk' pa molaj ri Iijoxela', richin nkib'än ri kisamaj.
•• Ri Iijoxela' nkib'ij jun kina'oj pa ruwi' ri na'oj e Iz'ib'aläl ch'ik.

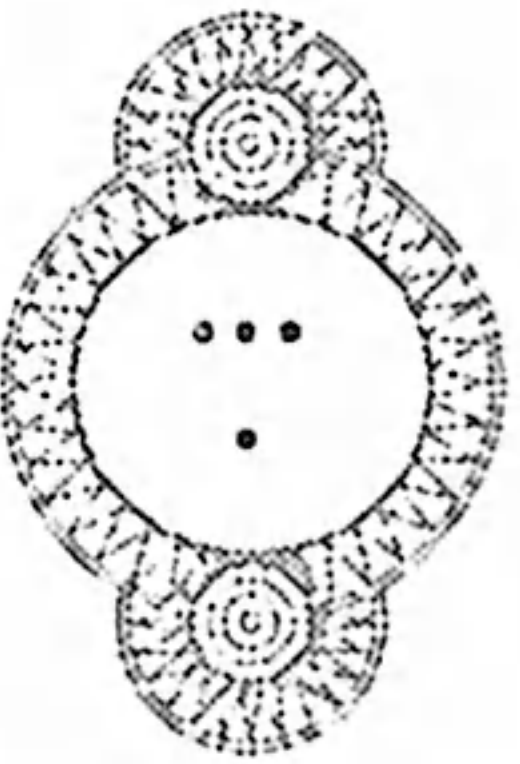

Tqab'ana' rachib'äl achike ri' ri jun utziläj ach'alalri'il.

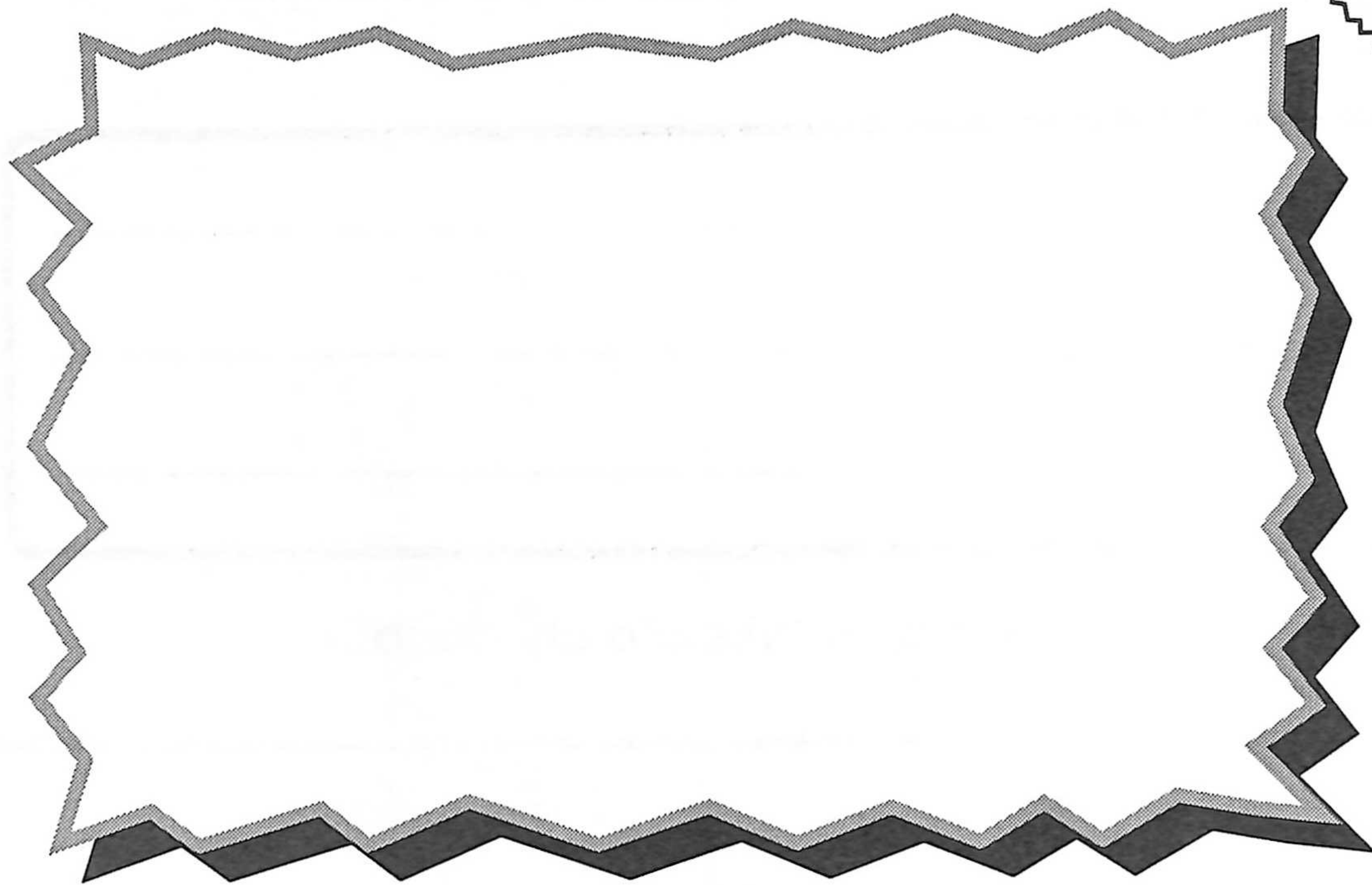

K'atzinel nqanimaj kitzij ri qate' tatata'.

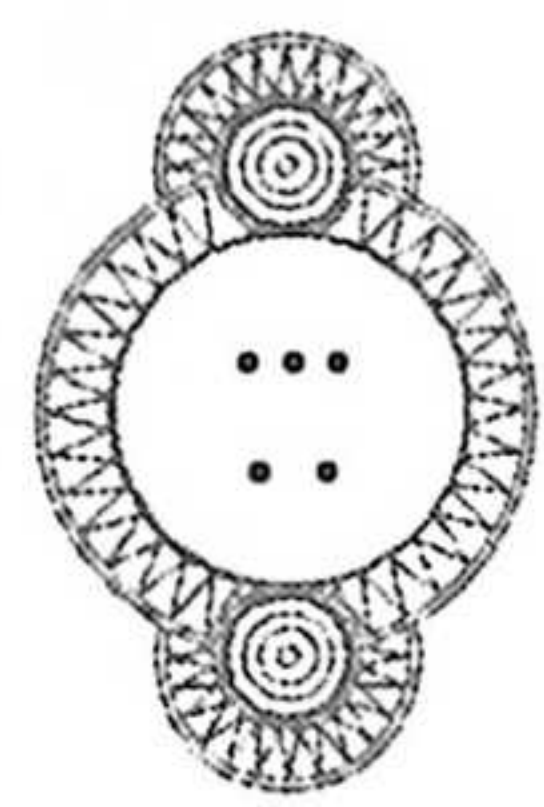

K'o rejqalem ri jun ach'alalri'il.

Ja'

Manaq

Ja'

Manaq

Rajowaxik nqamol qi' pa ruwi' jun samaj.

Ja'

Manaq

Tatz'ib'aj jun tawila' chi rij ri ach'alalri'il.

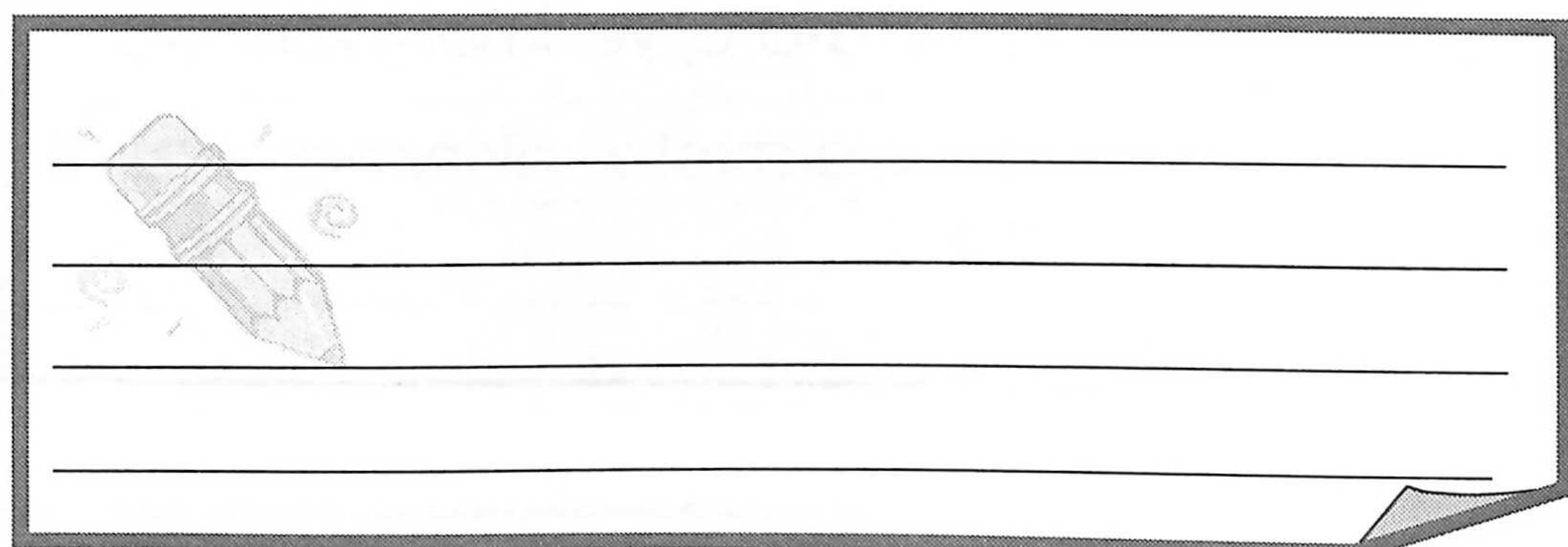

• Ri tijoxela' nkib'än ri nk'utux chi ke.
•• Ri tijonel yeruto' ri tijoxela' wi k'o achike nkajo' nkik'utuj

RO' TANAJ

Jalajöj ruwäch rutzijol nuya' ri kajulew



Ri etamanik nuq'i' ri tijoxel:

Nuch'ob' achike nuq'ajuj ri retal nuya' ri kajulew.
Nutz'ib'aj jalajöj na'oj ri nuya' ri kajulew.
Nq'alajin chuwäch jalajöj rub'eyal tzijonem e k'o.

Achike rutzijol qatz'eton



Tqatzijoj tqatz'ib'aj achike rutzijol qatz'eton.

Three horizontal lines for writing.

Tqab'ana rachib'äl ka'i' retal nuya' ri kajulew.

A large shaded rectangular area for writing.

Tqatz'ib'aj rub'i'

Two horizontal lines for writing.

Tqatz'ib'aj rub'i'

Two horizontal lines for writing.

A large shaded rectangular area for writing.

- Ri fjonel nutzijoj chi kiwäch achike ri rutzijol nuya' ri kaj.
- Ri fijoxela' nkitz'ib'aj achike rutzijol kitz'eton.
- Nkitz'ib'aj chuwäch ri kisik'iwuj.



Ri nuq'ajuj töq yeq'ax ri chikopi' al kib'i'

Pa molaj tqatzijoj tqatz'ib'aj ri nuq'ajuj ri k'o chuwäch ri achib'äl.



Tqak'utuj chi ke ri qate' qatata', pa jarupe' ramaj yeq'ax re al. Tqatz'ib'aj ri na'oj xkib'ij pe chi qe.

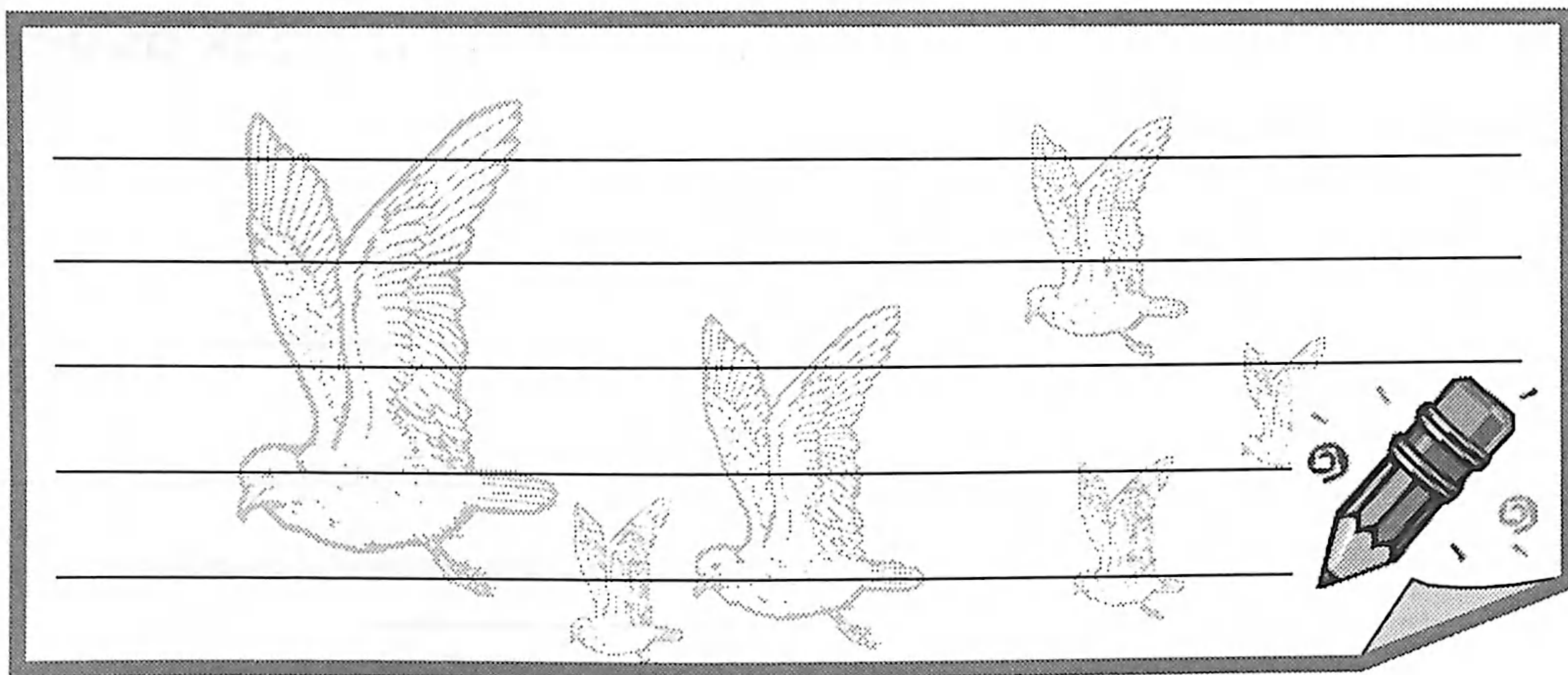

- Ri tijoxela' nkitzu' ri achib'äl pa molaj, k'a ri nkitz'ib'aj ri kina'oj.
- .. Ri tijonel nutz'aqatisaj ri na'oj chi kiwäch rije'.
- ... Ri tijoxela' nkitz'utuj pe chi ke ri kite' kitata'.



Kejqalem ri chikopi' ruma nkiya' rutzijol



¿Achike chikopi' qetaman kiwäch chi töq yeq'ajan, k'o jun na'oj nkiya' chi qe?

Man tqamestaj
chi ri qati't
qamama'
janila na'oj k'o
kik'in, ruma ri'
k'atzinel
yojtzijon kik'in

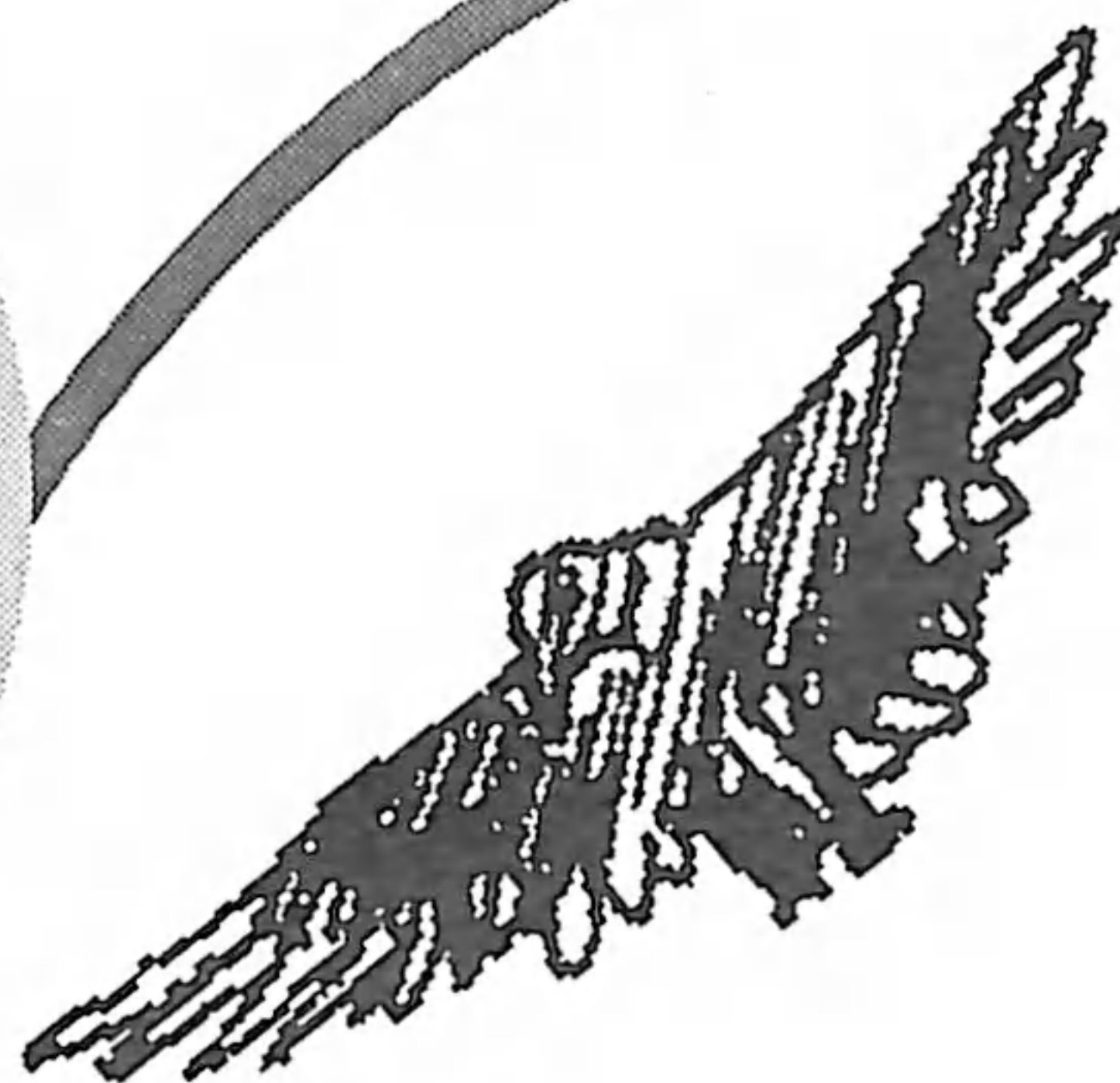

Tqatz'ib'aj achike retal nkiya' re chikopi' re' pa qak'aslem.

Ri utiw: _____

Ri al: _____

Ri k'uch: _____

Ri tukür: _____

- Ri tijonel nutzijoj chi kiwäch ri ak'wala' ri kejqalem ri chikopi'.
- Ri tijoxela' jeb'ël nkitzu' ri jujun achibäl.
- Ri tijoxela' nkitz'ib'aj achike rutzijol nkiya' ri jalajöj chikopi'.



Rub'eyal richin nab'än jun tzijonem

Pa maya' na'oj e k'o rub'eyal richin nab'än jun tzijonem, chi kikojol re', e k'o ri, pixa', q'olaj, lema', choloj, ch'ab'äl chi re ri Ajaw.

Ri jun pixa': ja ri' ri nokisäx töq ri te'e'j tata'aj yetzijon kik'in ri kalk'wal.

Q'olaj: ja ri' akuchi yetzijox wi ri kik'aslem ri chikopi'. Jantape' k'o jun na'oj nilitäj kan pa ruwi'.

Lema': Chupam jun lema', yetzijox na'oj ri kiq'axan kan ojer taq winaqi', chuqa' ri nkiq'axaj ri qate' qatata'.

Choloj: Ri choloj ja ri' ri jupaj kapaj tzij yeb'ix pa cholaj, nq'alaj chi kan kipach'un el jujun na'oj. Nokisäx wi, töq nk'utux jun ixtän.

Ch'ab'äl chi re Ajaw: Ja re' ri jun rub'eyal nokisäx richin kuyb'äl mak, richin matyoxinik, chuqa' pa ruwi' kikotem chuqa' pa ruwi' yab'il.

B'ixanik: Ja re' töq nb'an pa ruwi' samaj, kikotem chuqa' pa ruwi' b'is.

Pach'un tzij: Ja ri' nokisäx töq jun winäq nrajo' nub'ij jun na'oj, akuchi nkotz'ijäx rub'ixik ri na'oj.

Tqak'utuj chi ke qate' qatata', jujun chi ke re tzijonem xeqatz'ët kan. We majun ta nqil, tqakanoj pa sik'iwuj, k'a ri tqatz'ib'aj.

Jun pixa' pa ruwi' rutzijol nuya' ri kaj



Jun q'olaj:



Four horizontal lines for writing.

Jun lema':

Four horizontal lines for writing.

Jun choloj:

Four horizontal lines for writing.

Ch'ab'äl chi re ri Ajaw:

Four horizontal lines for writing.

B'ix:

Four horizontal lines for writing.

- . Ri tijonel nutzijoj chi kiwäch achike ri', ri rub'eyal natz'lb'aj jun tz'ljonem.
- .. Ri tijoxela' nkisik'lj ri jarupe' kiwäch ri tzijonem e k'o.
- ... Ri tijoxela' nkitz'lb'aj ri jujun kiwäch tzijonem.

Rokisaxik ri rub'eyal jun tzijonem

Tqak'utuj chi ke qate' qatata' achike rub'anon ri sutz' chuwäch ri kaj töq npe saqb'och, töq npe jäb' töq npe kaq'iq'. Ronojel re' na'oj re nqab'an rachib'al chuqa' nqatz'ib'aj ri nuq'ajuj.

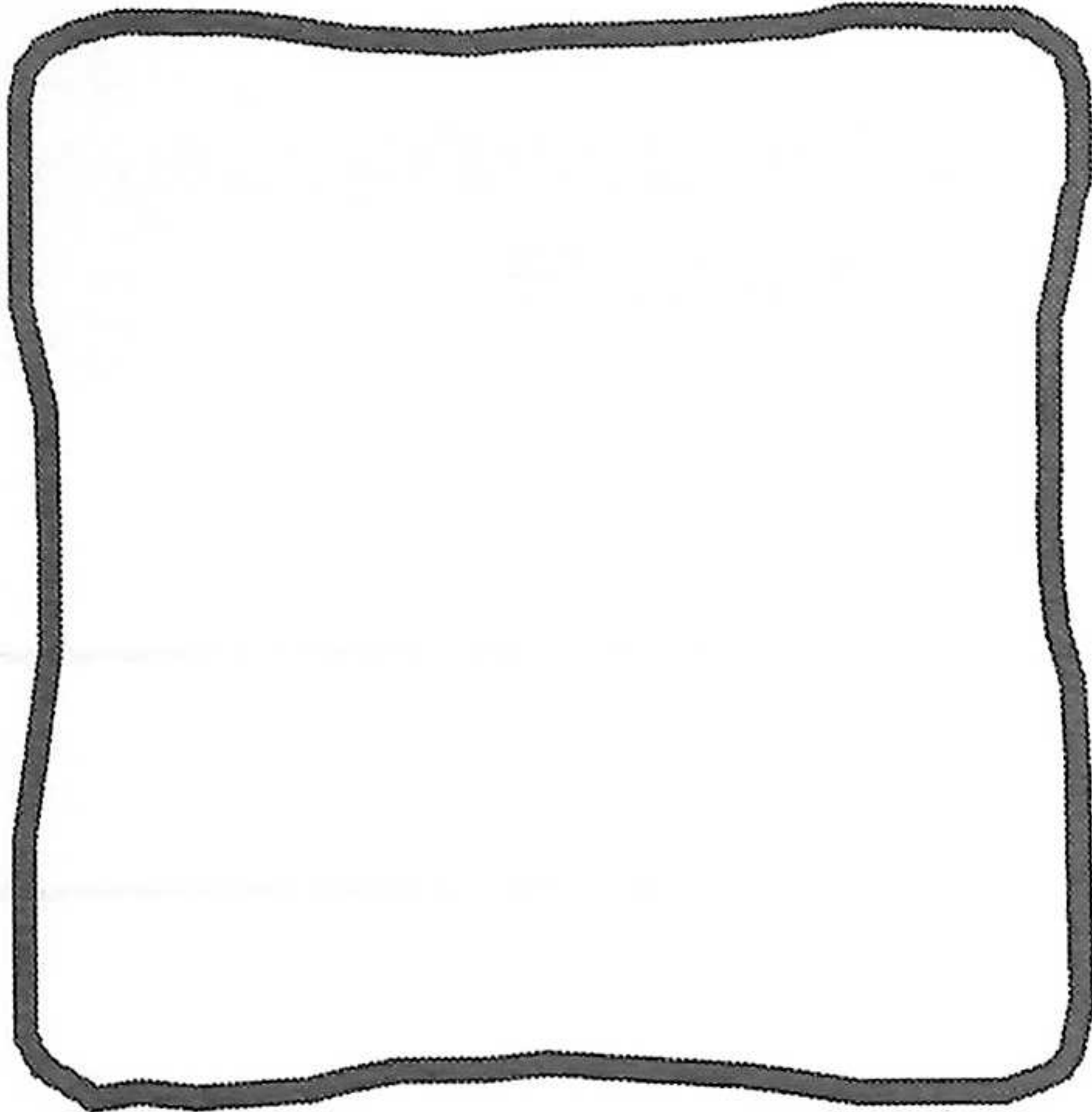

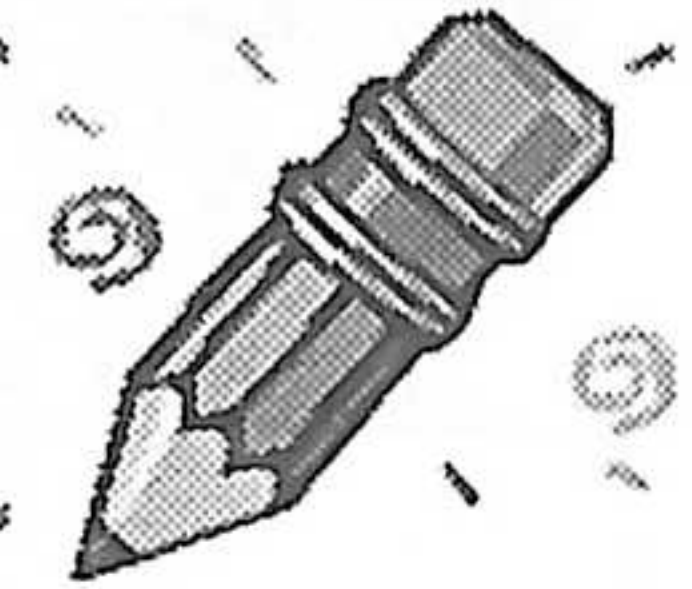

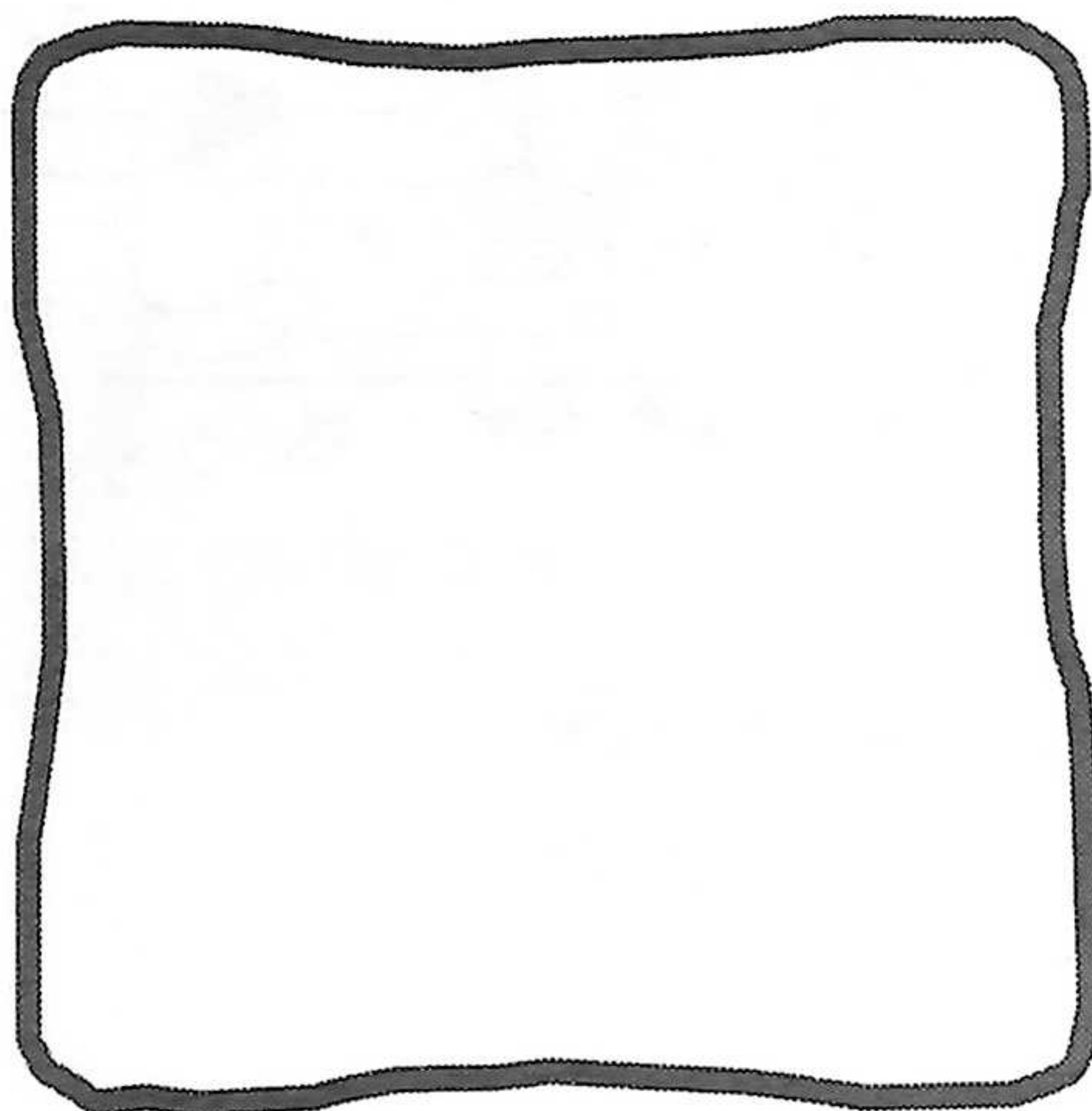
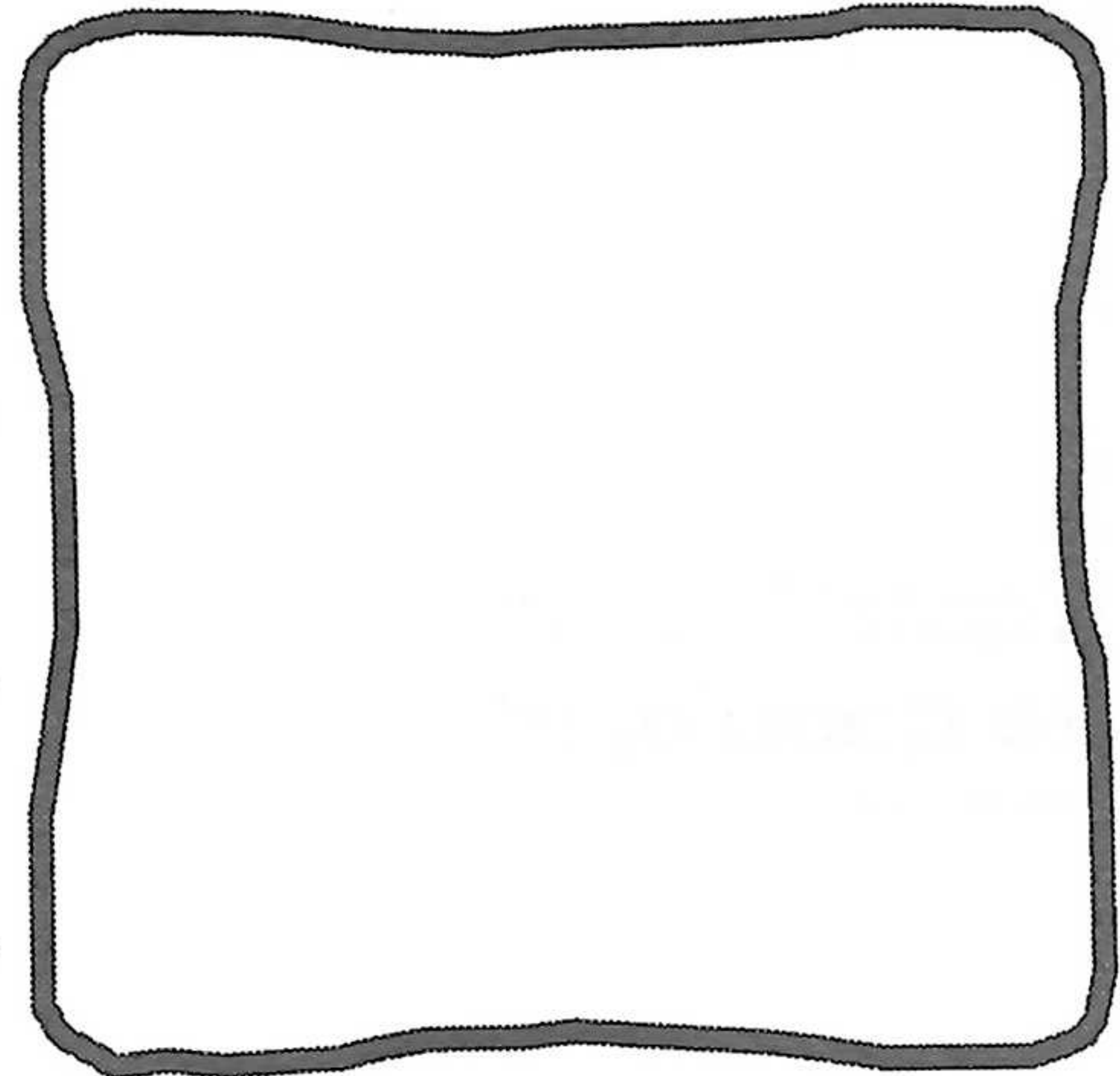



- Ri tijonel nutzijoj rub'eyal richin rukanoxik ri na'oj chi kochoch.
- Ri tijoxela' nkitz'ib'aj ri nuq'ajuj ri jujun k'utunik.
- Töq xtikik'is k'o chi nkisik'ij.

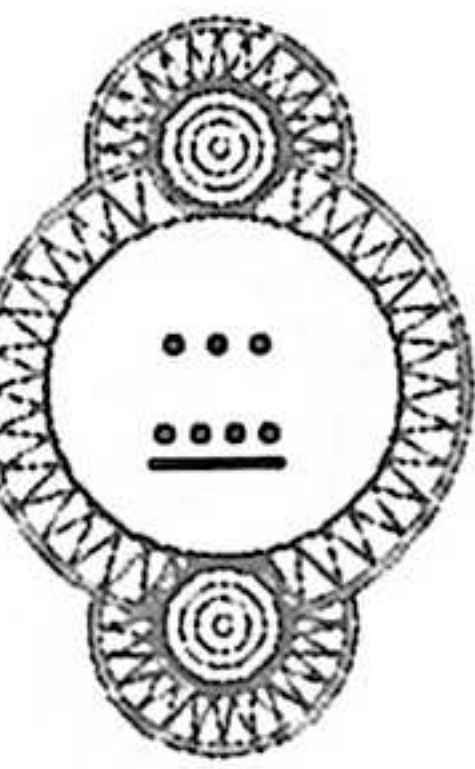

Samaj k'atzinel nb'an pa ruwi' ri rutzijol nuya' ri kajulew



Richin nqichinaj kan ri kina'oj ketamab'al ri qati't qamama', k'atzinel yojtzijon kik'in ri je'.



Tqatz'ib'aj jun qana'oj pa ruwi' re na'oj re'.

Ri kina'oj ri qate' tatata', man xtik'is ta we, jantape' xtiqatz'ib'aj kan.

Tqatz'ib'aj jun na'oj pa ruwi' re qana'oj re'.





Jun chik rub'eyal richin nqaköl re jalajöj taq na'oj, ja ri nqatzijoj chi ke ri qach'alal ronojel re na'oj re'.

- Ri tijonel nuchojmirisaj ri na'oj chi kiwäch ri tijoxela'.
- Ri tijoxela' nkitz'ib'aj ri nuq'ajuj jujun k'utunik.
- Töq xtkik'is k'o chi nkisik'ij.



Tqamolo' ruchi' ronojel ri na'oj xeqil pa ruwi' ri rutzijol nuya' ri kajulew.

Rutzijol nkiya' ri chikopi'.

Large rectangular box with horizontal lines for writing.

Rutzijol nuya' ri kaj

Large rectangular box with horizontal lines for writing.

Tatz'ib'aj ri kiwach tzijonem e k'o

Large rectangular box with horizontal lines for writing.

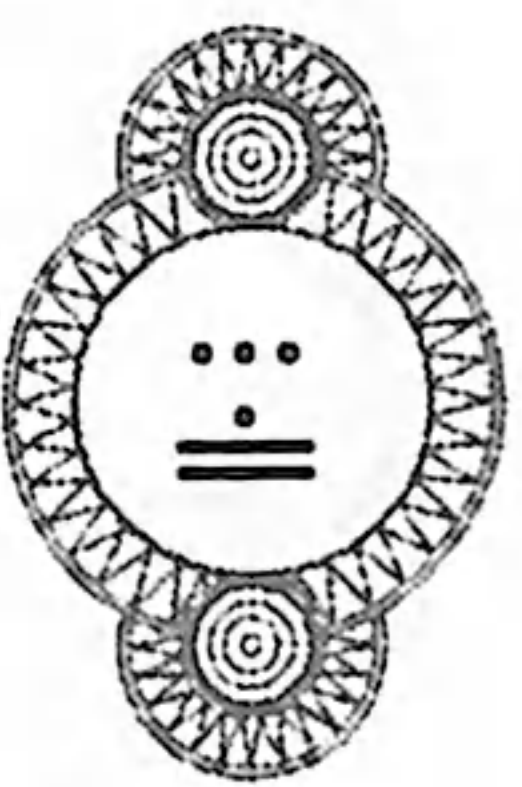

• Ri tijonel nutzijoj rub'eyal re jun samaj re'.
•• Ri tijoxela' nkitz'aqatisaj ri jujun taq rub'eyal k'utunik.

Rik'in kikotem tqatzijoj achike k'ak'a' taq na'oj xeqil



Pa molaj nqatzijoj chi kiwäch ri qachib'il ri na'oj xqasöl.

Nab'ey molaj: Achike rutzijol nkiya' ri chikopi' chi qawäch.

Ruka'n molaj: Rub'eyal rutzijol nuya' ri kaj chi qawäch.

Rox molaj: Achike rub'eyal tzijonem e k'o.

Rukaj molaj: Nqab'än kachib'äl ri chikopi' ri xb'an tzijonem
pa kiwi'.

- . Ri tijonel yerunuk' pa molaj ri tijoxela' richin nkib'än ri kisamaj.
- .. Ri tijoxela' nkitz'ib'aj achike xk'utux chi ke.
- ... Töq nkitz'ib'aj yeq'ax chi kiwäch ri kachib'il richin nkitz'ijoj ri kisamaj.

RUWAQ

TANAJ

Rub'anikil Rub'anob'al qatinamit

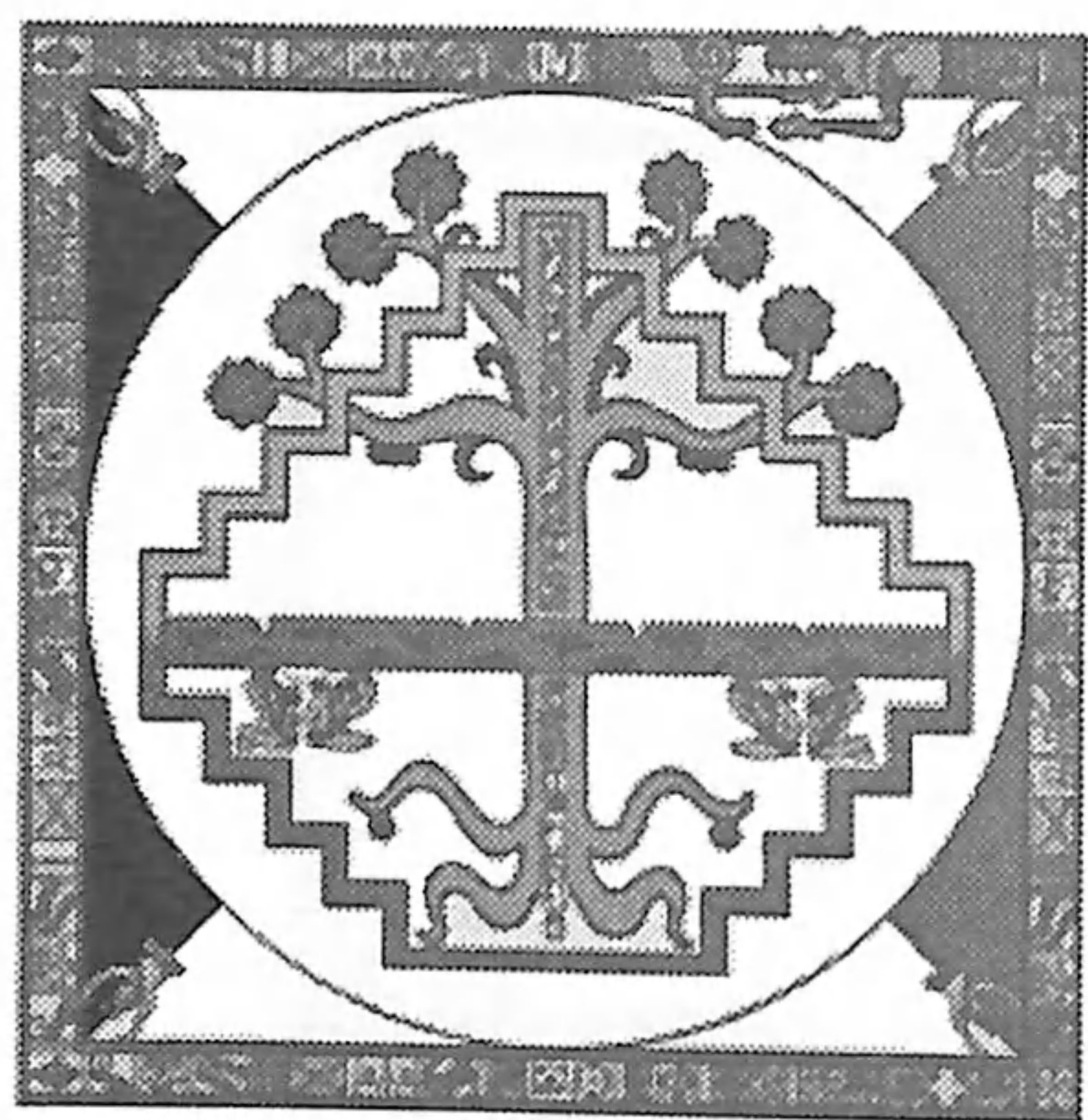
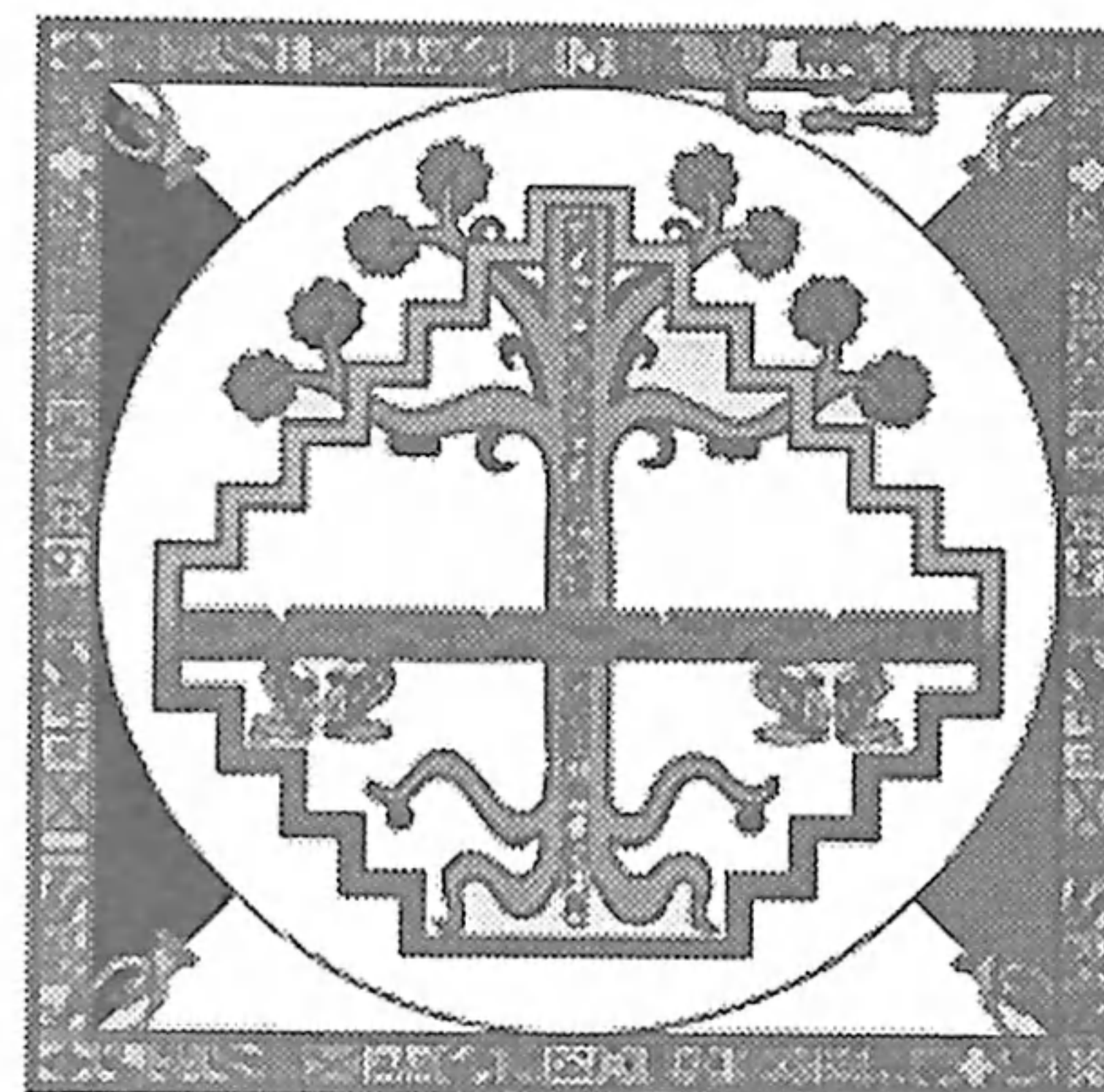

Ri etamanik nuq'i' ri tijoxel:



Nutz'ib'aj ri rub'anikil rub'anob'al ri qatinamit.

Nutz'uk na'oj pa ruwi' ri b'anikil b'anob'al.

Nuch'ob'rij ri ruxe'el ri maya' b'anob'al.

Ri b'anikil yesamajix pa qatinamit

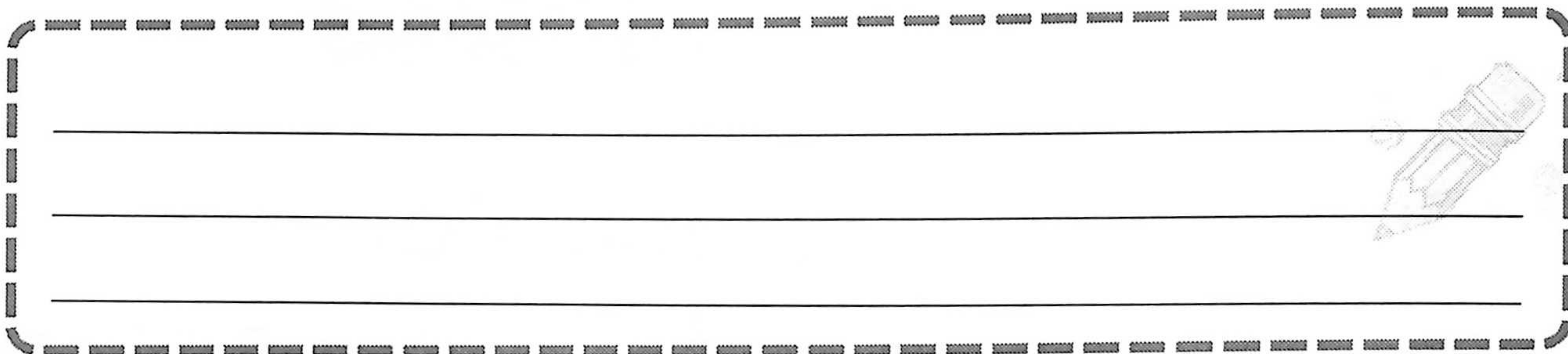
1 Tqatzijoj tqatz'ib'aj achike b'anikil yesamajix pa qatinamit.



2 Tqatz'ib'aj jun pixa' pa ruwi' jun b'anikil xqatz'ib'aj yan.



3 Tqasik'ij chi kiwäch qachib'il ri pixa' xqatz'ib'aj.

4 Tqach'olajij ri na'oj xkib'än ri qachib'il.

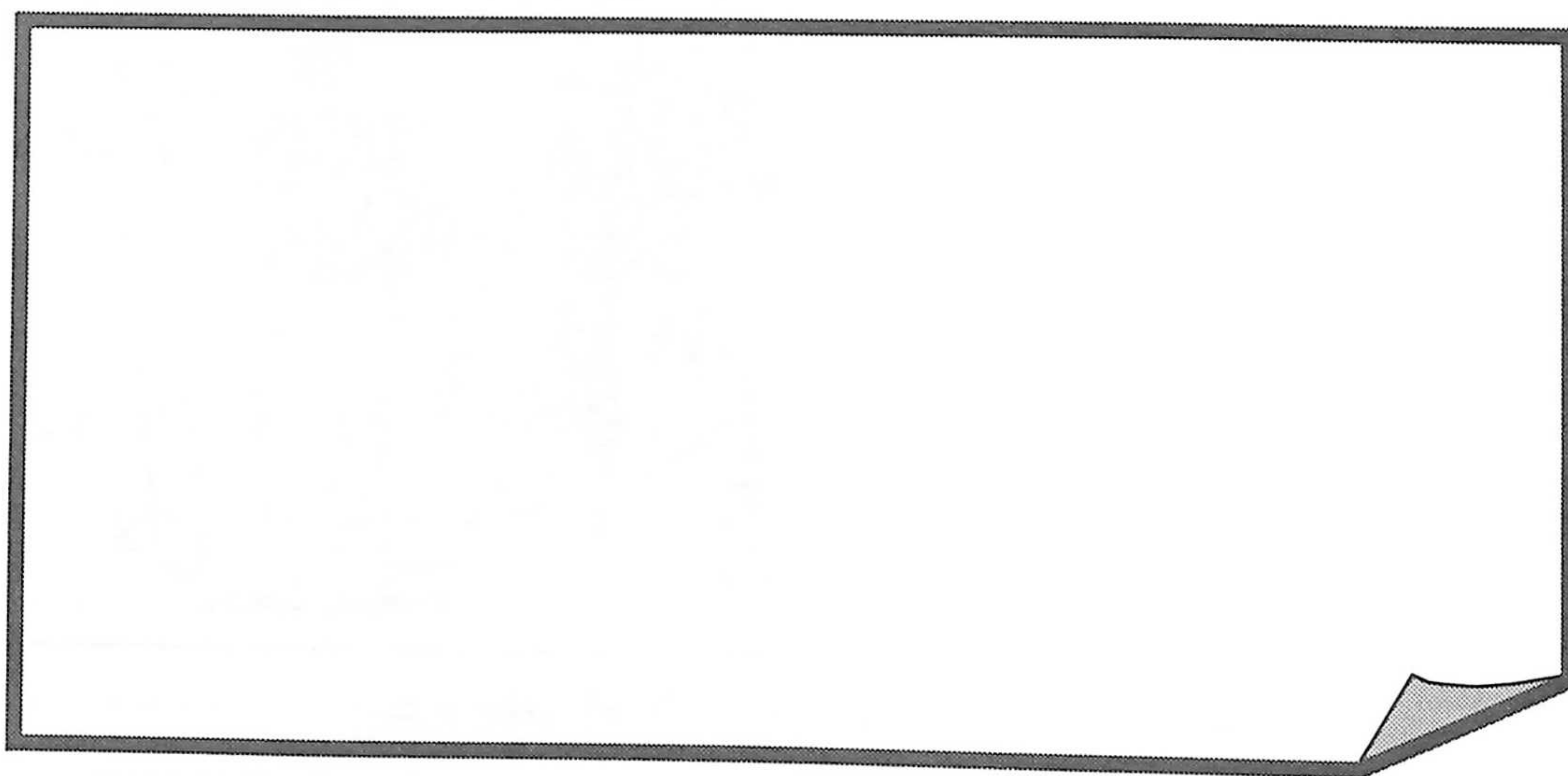

- 
- Ri tijoxela' nkltz'ib'aj ri na'oj pa taq kajtz'uk.
 - Ri tijonel k'o chi nusöl chik jub'a' achike ri' ri jun pixa'.



B'anob'äl ri k'a e k'o na pa qatinamit

1 Kojtzijon pa kiwi' ri b'anob'äl k'a yesamajix na. Keqacholajij wawe'.

Two columns of horizontal lines for writing.

2 Tqacha' jun chi ke ri b'anob'äl, k'a ri nqatz'uk jun pach'un tzij pa ruwi'.

A large, irregularly shaped box for drawing or writing.

Tqapach'ujij chi kiwäch ri qachib'il.

K'atzinel chi ri tijonel nusöl rij achike ri' ri b'anob'äl.



Tqatz'ib'aj na'oj pa taq b'ab' pa ruwi' ri b'anikil chuqa' b'anob'äl ri yesamajix pa qatinamit.



Tqab'ana rachib'äl ri jun b'anob'äl qetaman.

- .. Ri tijonel nuya' rub'ixlk chi ke ri tijoxela', rub'eyal ri samaj.
- ... Ri tijoxela' yetz'ib'an chuqa' nkib'an rachib'äl ri b'anob'äl.



Rejqalem ri nqichinaj ri qab'anikil qab'anob'al.



Tqatz'ib'aj na'oj pa ruwi' ri achib'äl

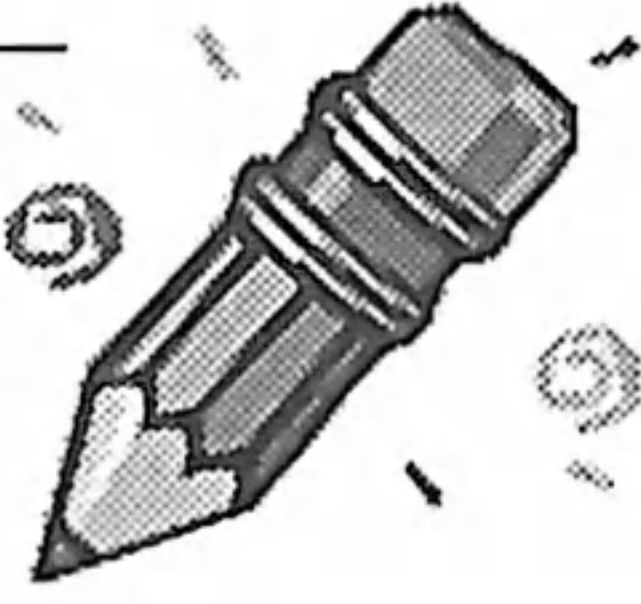

Pa maya' na'oj nim rejqalem ri winäq
 töq richinan rub'anikil rub'anob'al.
 Ruma rija' tikirel nch'ob'on pa ruwi'
 jalajöj taq samaj.

- Ri tijonel nutzijoj achike ri rub'anikil ri b'anob'al.
- Ri tijoxela' jeb'el nkitzu' ri achib'äl k'a ri' nkitz'ib'aj ri kina'oj xkitzu' pa ruwi'.



Tqatz'eta jun ka'i' oxi' na'oj.



Ri winäq jikil rub'anikil ja ri', ri ntikir nch'ob'on pa nïm, ntikir nusöl chuqa' nunük' jeb'ël taq na'oj pa ruwi' ruk'aslem chuqa' pa ruwi' rutinamit chuqa' tikirel nkijunamaj kina'oj kik'in winaqi' ri jun chik kib'anob'al.

Rat Ixkab', tatzijoj chwe ¿achike ri', ri b'anob'äl?

Kanek, ri maya' b'anob'äl ja ri', ri rub'eyal kik'aslem ri ojer qati't qamama'.



Ixkab': Rïn chuqa' wetaman chi ojer kan xkisamajij rub'eyal rub'anon ri ik', ri ch'umila', ri q'ij ronojel re' ruximon ri rik'in ri qak'aslem.

Kanek: Chuqa' ri ojer kan janila kiya'on pe nïm rejqalem ri ruwach'ulew. Richin xematyoxin k'o chi xkib'anala' kixukulem.

. Ri tijonel k'o chi nusöl ri na'oj chi kiwäch ri tijoxela'.
.. Ri tijoxela' nkisik'ij pa taq molaj re jujun na'oj.



Rokisaxik ri maya' b'anikil maya' banob'äl

Tqatz'ib'aj chuwäch nima'q taq wuj: E achike maya' taq b'anob'äl xeqil yan.

Two columns of horizontal lines for writing practice.



Tqak'utuj chi ke qach'alal pa jay, achike ri', ri maya' b'anob'äl. Tqatz'ib'aj pe ri na'oj.



A large rectangular box containing four horizontal lines for writing practice.

Pa molaj, tqasik'ij ri na'oj chi kiwäch ri qachib'il.



Ri tijonel nuk'üt rokisaxik ri nima'q taq wuj.



Kojtzijon kik'in qach'alal pa ruwi' ri maya' b'anob'äl. Tqatz'ib'aj ri k'ak'a na'oj xetzijöx pe chi qe.



Large writing area with horizontal lines and a pencil icon at the bottom right.

Tqatz'ib'aj pa qasik'iwuj ka'i' b'anob'äl, k'a ri nqab'än kachib'äl.

Jun pach'un tzij

Jun q'oloj

Writing area for 'Jun pach'un tzij' with horizontal lines and a pencil icon at the bottom right.

Writing area for 'Jun q'oloj' with horizontal lines and a pencil icon at the bottom right.

Kojtzijon kik'in qachib'il pa ruwi' ri maya' b'anob'äl

- .. Ri tijonel nuya' el kisamaj ri ak'wala'.
- .. Ri tijoxela' yetz'ib'an pa ruwi' ri na'oj nk'utux chi ke.
- ... Ri tijoxela' nkiya' taq kitzijonem.

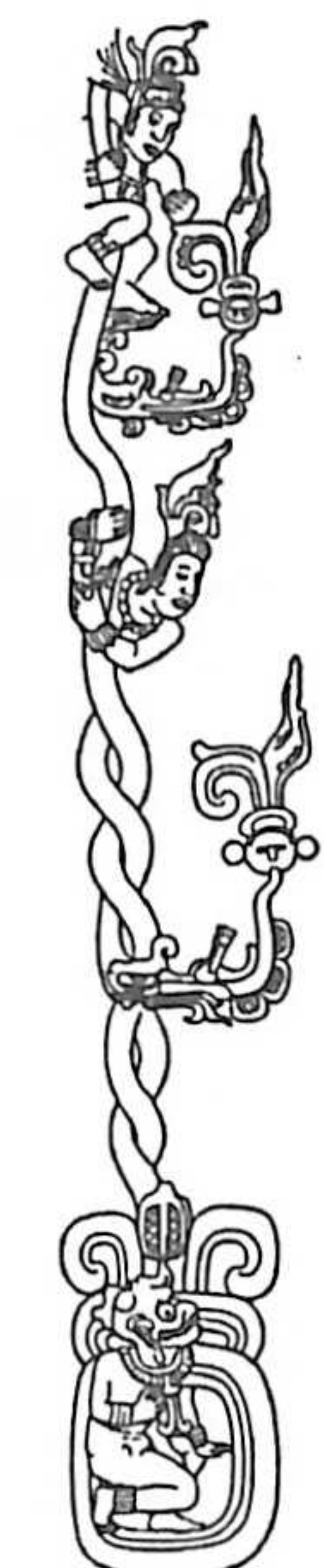



Tqamolo' ruchi ri qana'oj

Tqatz'ib'aj re jun ka'i' oxi' na'oj re'.

Achike b'anikil
k'a e k'o na
pa qatinamit

Na'oj pa taq kem (tz'eteb'äl)

Achike
b'anob'äl k'a e
k'o na pa
qatinamit

Rejqalem ri matyoxinik (tz'eteb'äl)

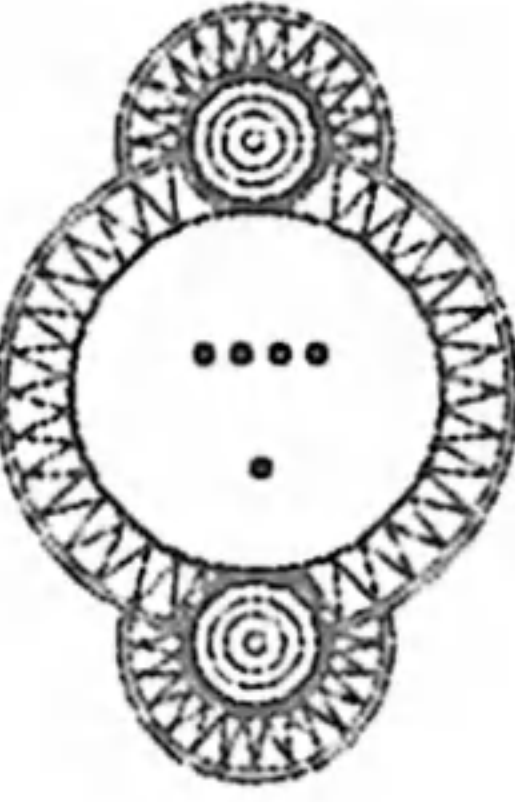

Tqatz'ib'aj kib'i' oxi' b'anob'äl yalan üt z xqatz'ët.



Nqab'än kachib'äl ri jujun na'oj xeqatz'ib'aj yan.

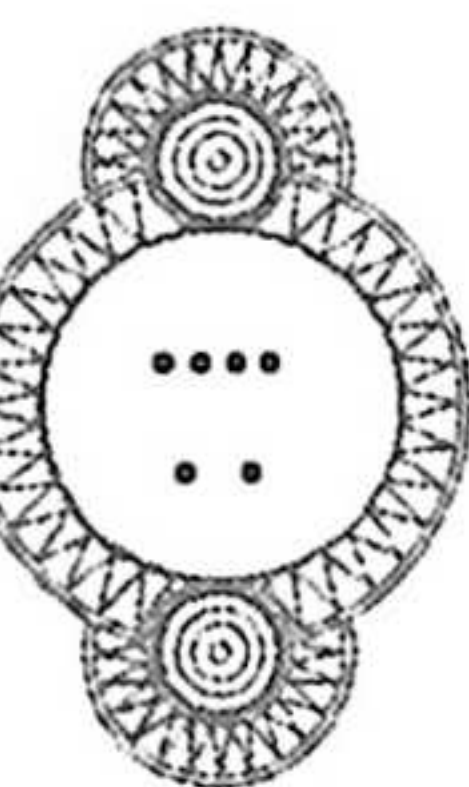

Ri tijoxela' nkitz'ib'aj chuqa' nkib'än rachib'äl ri na'oj.

RUWUQ TANAJ

Rejqalem ri qati't ik' chuqa' ri
qatata' q'ij pa qak'aslem



Ri etamanik nuq'i' ri tijoxel:

Nuch'öb' jalajöj na'oj pa ruwi' ri qati't ik' chuqa' ri qatata' q'ij.

Nutz'ib'aj na'oj ri ruximon ri' rik'in ri ik'.

Nusöl na'oj pa ruwi' rub'eyal ruximon ri' ri ik' rik'in ri tiko'n.

Na'oj pa ruwi' ri qati't ik' chuqa' ri qamama' q'ij



Tqak'utuj chi ke qate' qatata'
achike ketaman pa ruwi' ri ik' chuqa' ri q'ij.

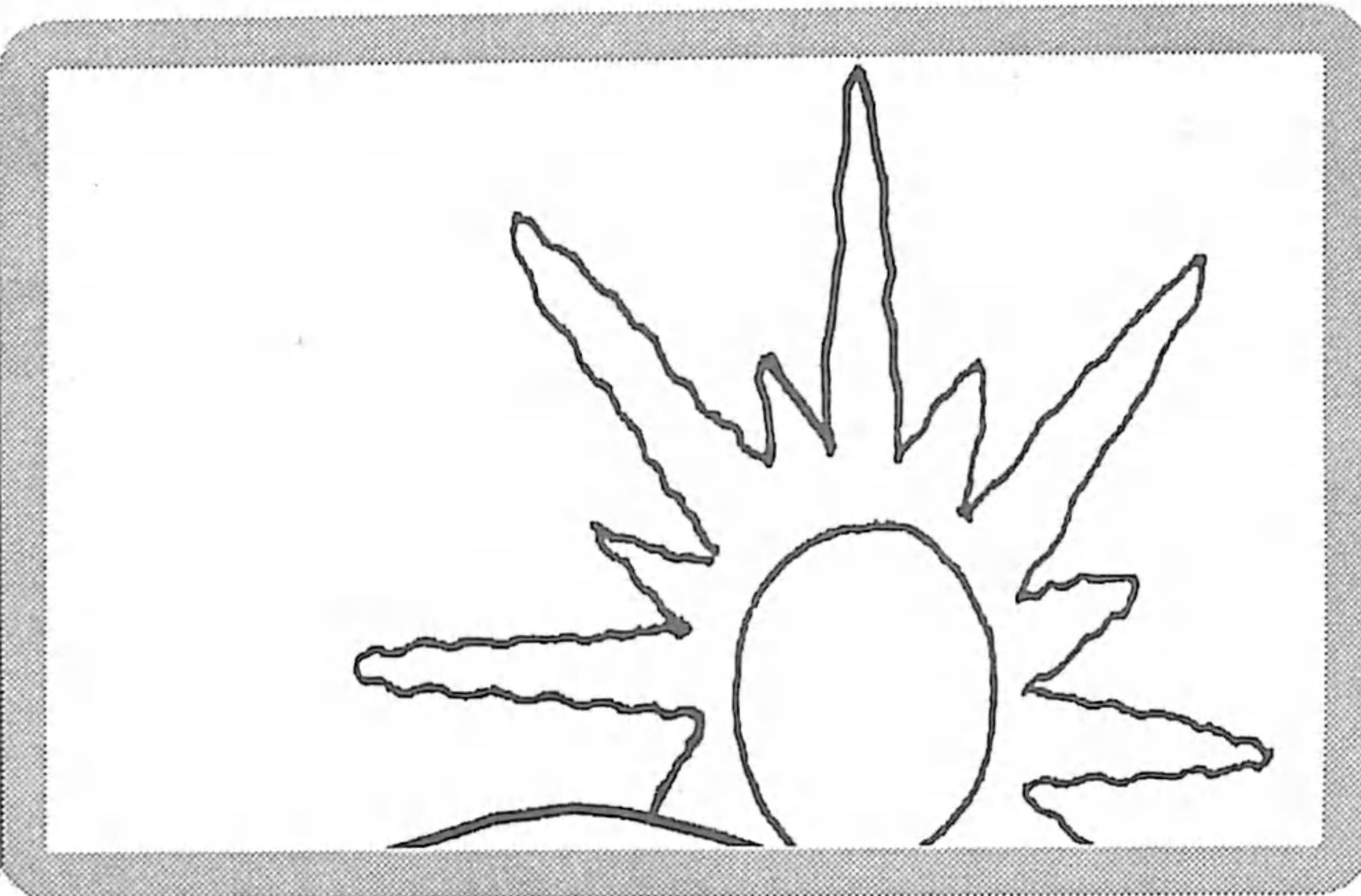
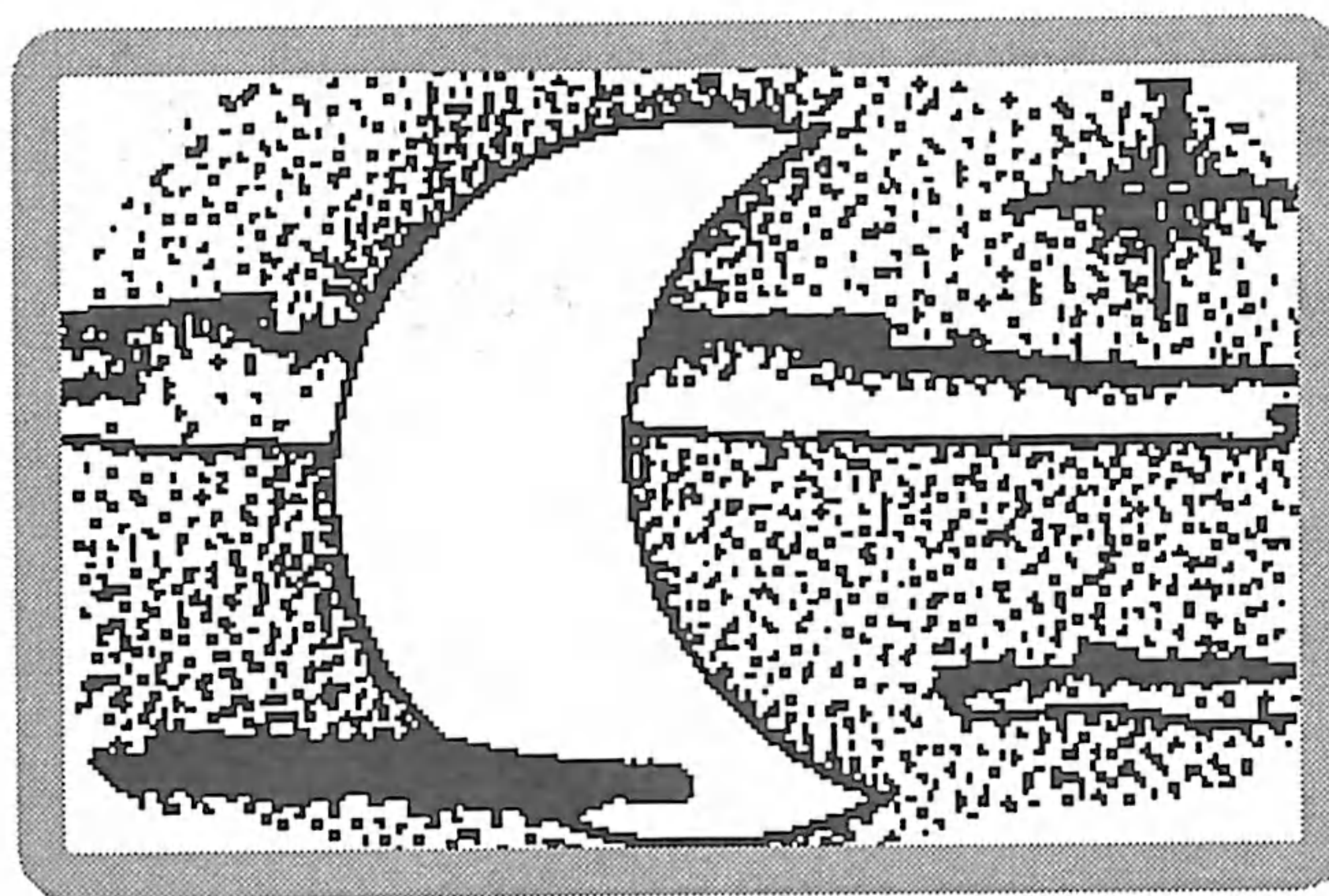

Tqatz'ib'aj achike na'oj xkib'ij pe ri qate' qatata'.

Pa molaj tqatz'uku' jun b'ix rik'in ri na'oj.

Ri tijoxela' nkik'utuj pe ri na'oj chi taq kochoch.



Rejqalem ri qati't ik' chuqa' ri loq'oläj q'ij töq yojtiko'n

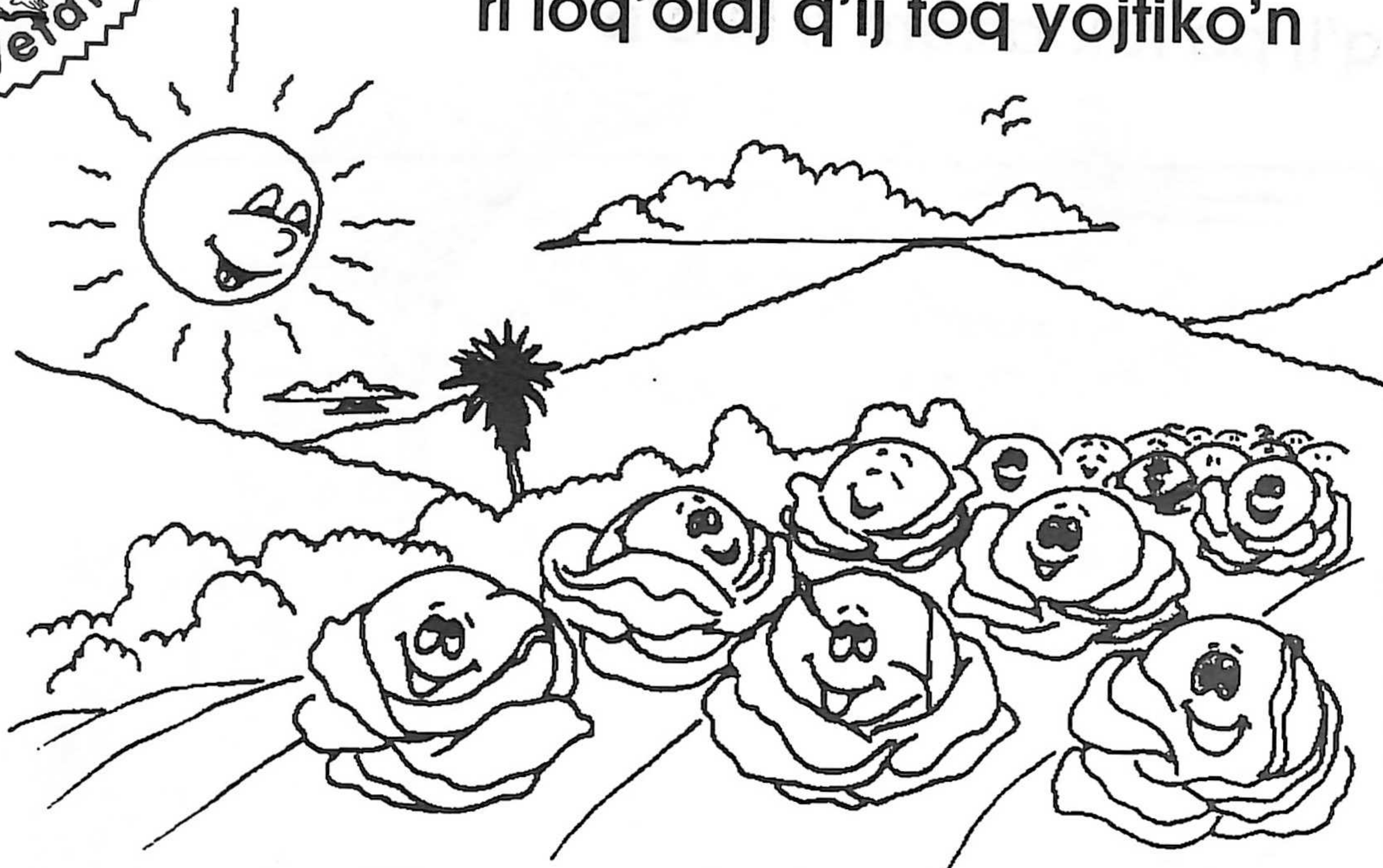

Ojer kan ri qati't qamama' yalan nkiya' rejqalem
ri rub'anikil ri ik', pa ruwi' ri tiko'n, pa ruwi' ri awäj.
Xa xe k'a ke ri' xk'oje' ruk'u'x ronojel ri xkisamajij.

Tqatzijoj pa taq molaj achike nuq'ajuj töq alaj ri ik'.

Handwriting practice box with three horizontal lines.

Tqakanoj, tqatz'ib'aj jun lema' pa ruwi'ri qati't ik'.

Handwriting practice box with three horizontal lines.

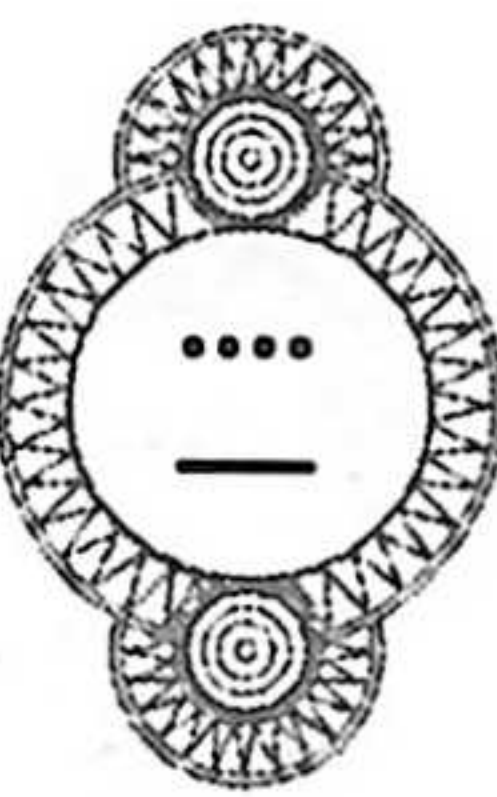

Rutzil nub'än ri qatata' q'ij pa ruk'aslem ri tiko'n

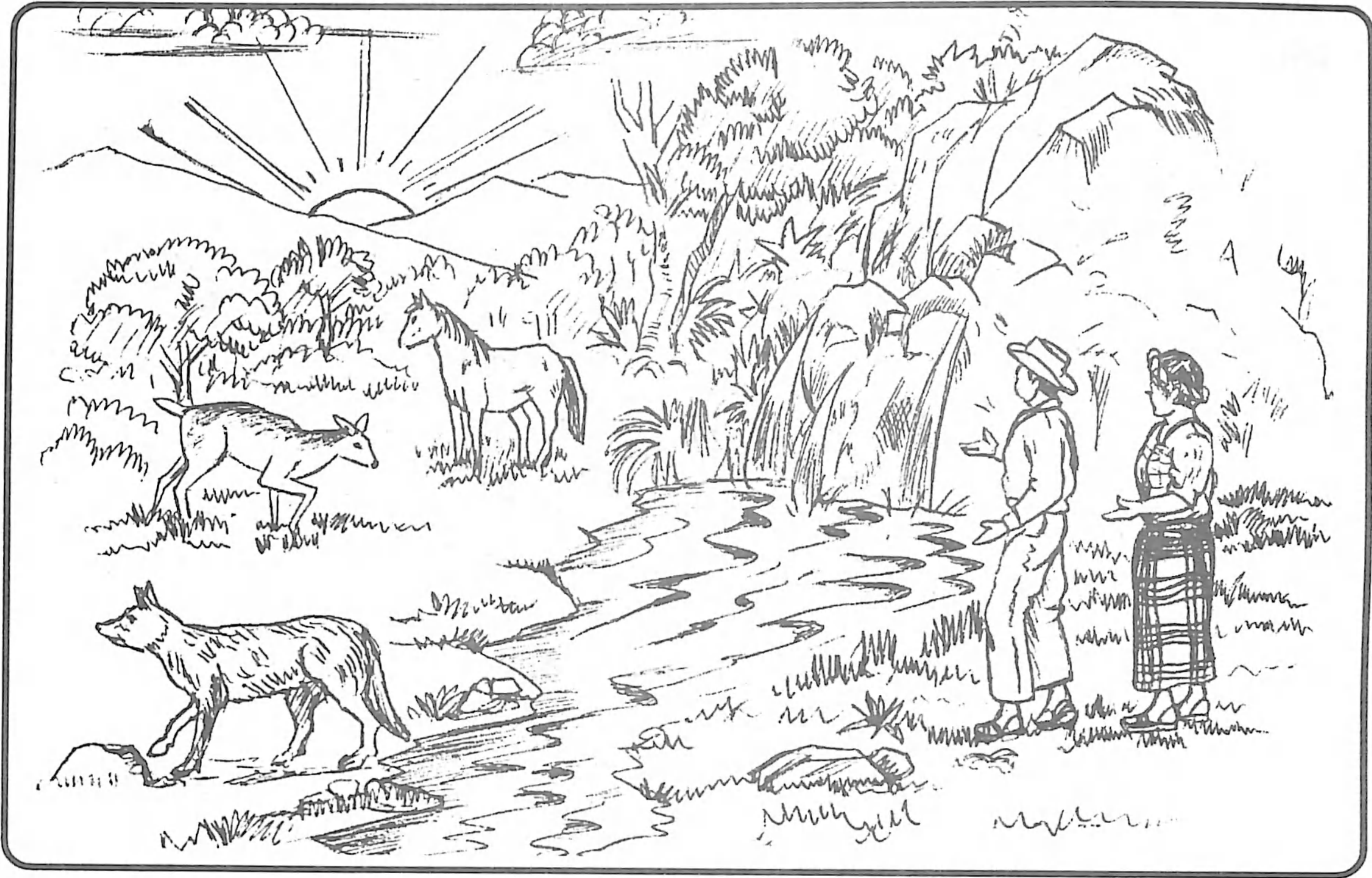

Ri qamama' q'ij numeq' ri qate' ruwach'ulew;
jantape' ri tiko'n tik'asäs nk'iy pe.

Tqatz'ib'aj ka'i' tawila' pa ruwi' ri qatata' q'ij

Blank writing area with horizontal lines and a pencil icon in the top right corner.

Blank writing area with horizontal lines and a pencil icon in the top right corner.

- Ri tijoxela' nkisik'ij ri jun pixa'.
- Ri tijonel nusöl chi kiwäch ri tijoxela' achike nb'ek'ulun wi ri jun pixa'.



Rejqalem ri qati't ik'.

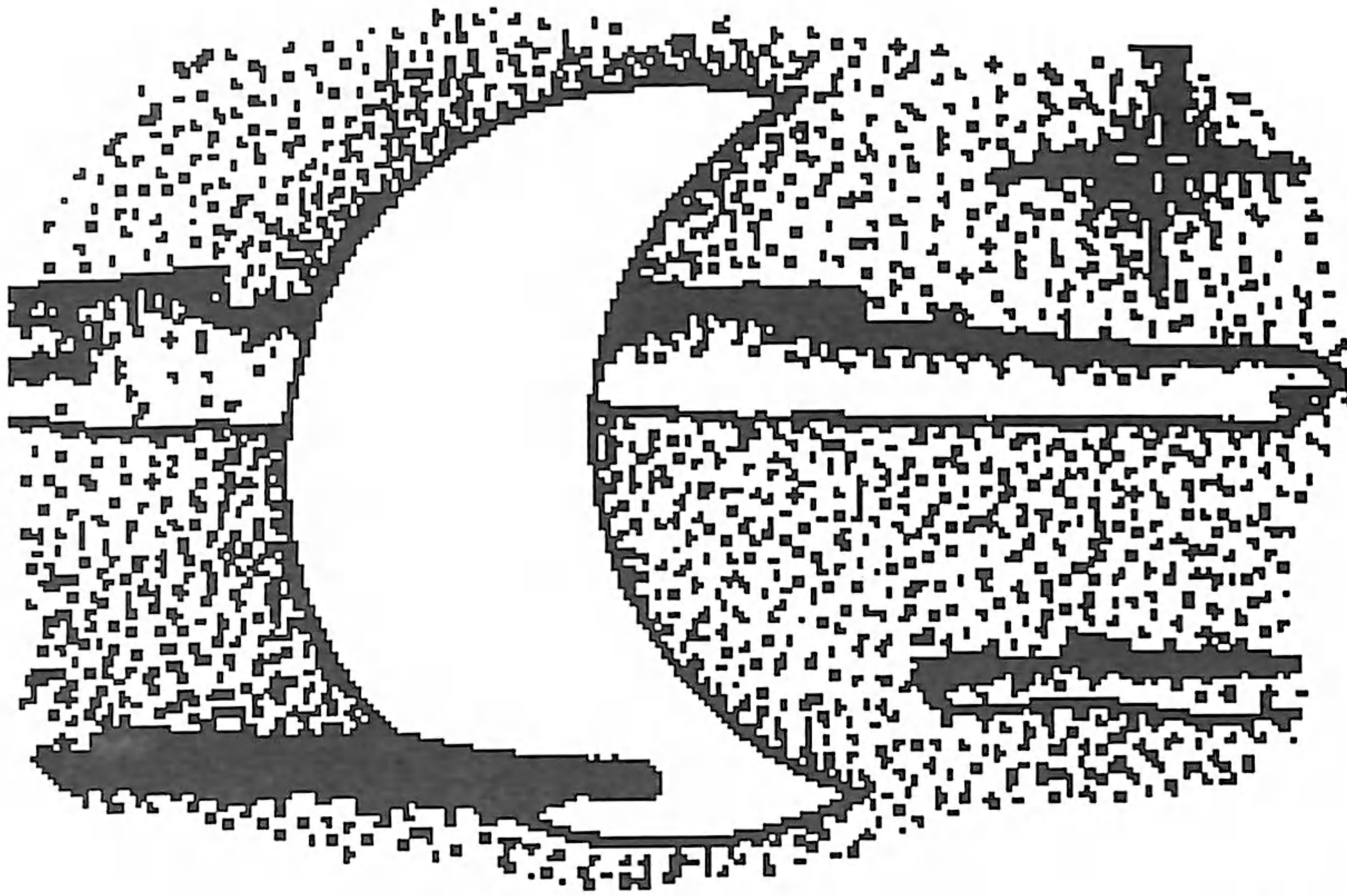

Pa maya' na'oj ri qati't ik' yalan nım rejqalem. We man nawoqaj ta, jik man pa rub'eyal ta nub'an ri atiko'n. Töq alaj ri qati't ik', man tikirel ta naqasaj jun che', ruma ri si' man ützt ta nk'at. We yajach'on nchikopir ri awixin.

Töq yasokotäj pa alaj ik', k'o nım kayewal ruma man npa'e ta chik ri akik'el.



Kojtzijon pa ruwi' ri na'oj xqawak'axaj.

Tqatz'ib'aj chuwäch nima'q taq wuj ri na'oj xeqatzijoj.



- .. Ri fijonel nutzijoj chi kiwäch ri ak'wala' ri na'oj tz'ib'atäl kan.
- .. Ri fijonel yerunuk' pa taq molaj richin yetzijon chuqa' yetz'ib'an.

Pa maya' na'oj ri qatata' q'ij yalan nım rejqalem. Ri ruchuq'a' ri loq'oläj q'ij yalan nk'atzin chi ke ri jalajöj tiko'n. Töq man nril ta q'ij jun tiko'n yalan wach'awik ruki'il, chuqa' man kan ta nk'iyir ta. We jun tzob'aj awän man, nejqanäj ta, jantape' ya' ya' nub'än rupam.

Tqatz'ib'aj ri kutzil nkib'än ri qati't ik' chuqa' ri qatata' q'ij pa ruwi' ri tiko'n chuqa' pa ruk'aslem ri winäq.

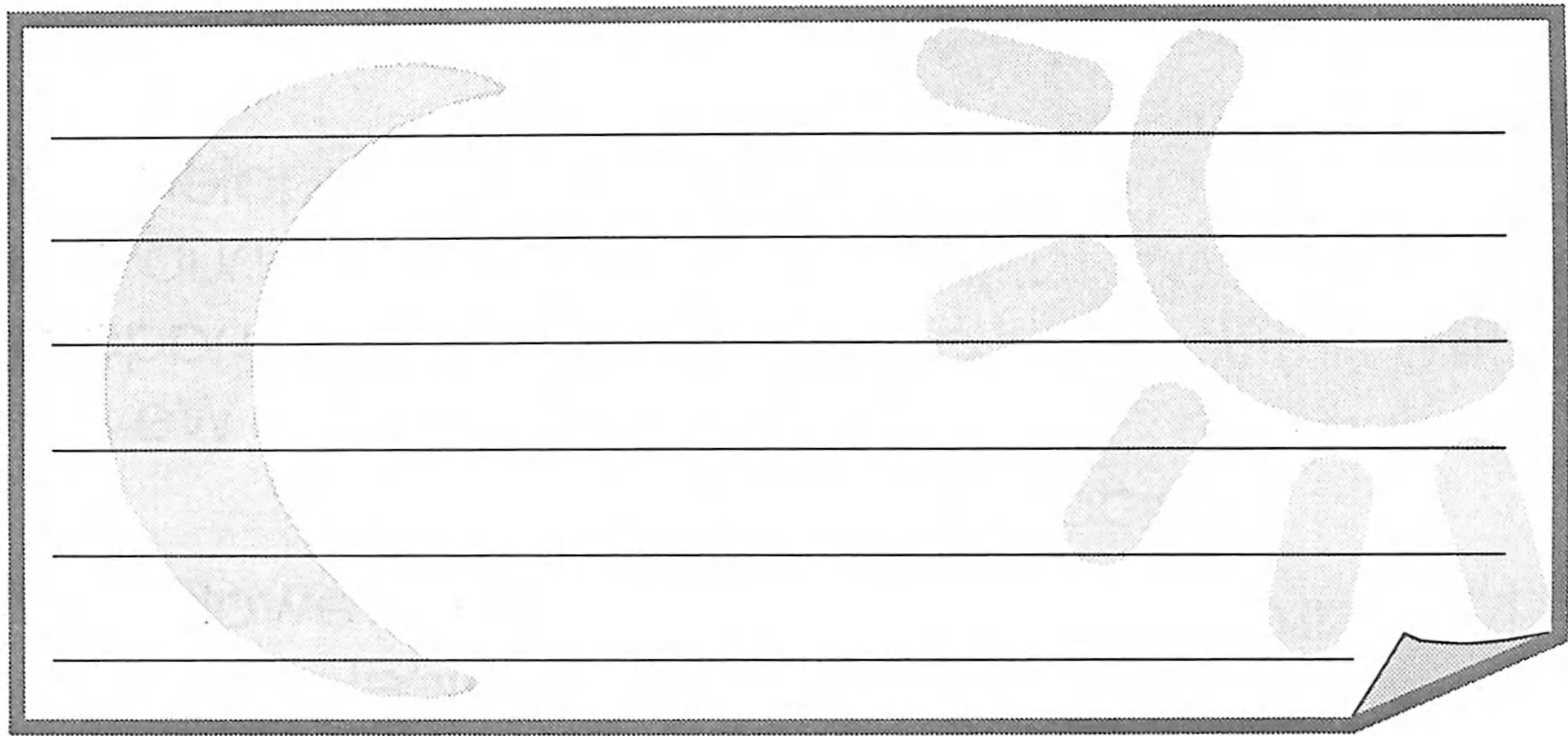

Tqab'ana' rachib'äl re na'oj xqatz'ib'aj.

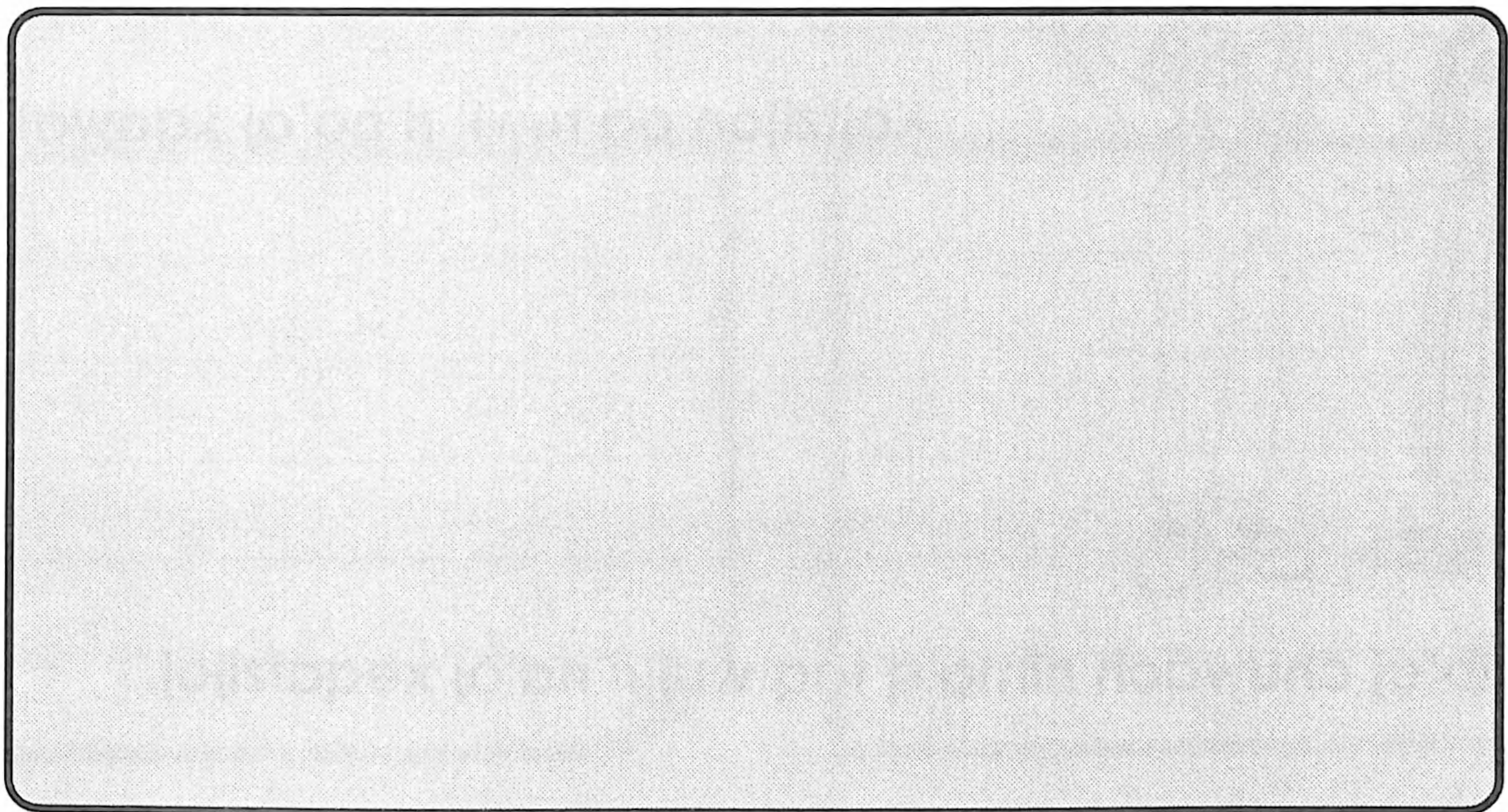

- Ri tijoxela' nkisik'ij re na'oj tz'ib'atäl.
- Ri tijonel nutz'aqafisaj ri na'oj.



Ri qati't ik' nuya' jun utziläj rub'ey ri qak'aslem

Tqatz'ib'aj achike ruma nım ruq'ij ri qati't ik'.

Large rectangular box with three horizontal lines for writing.

Tqak'utuj chi ke ri qati't qamama', achike chik na'oj ketaman rije' pa ruwi' ri qati't ik'.

Large rectangular box with three horizontal lines for writing.

Pa molaj tqatzijoj chi kiwäch ri qachib'il pa tijonijay, ri na'oj xeqak'äm pe pa qochoch.

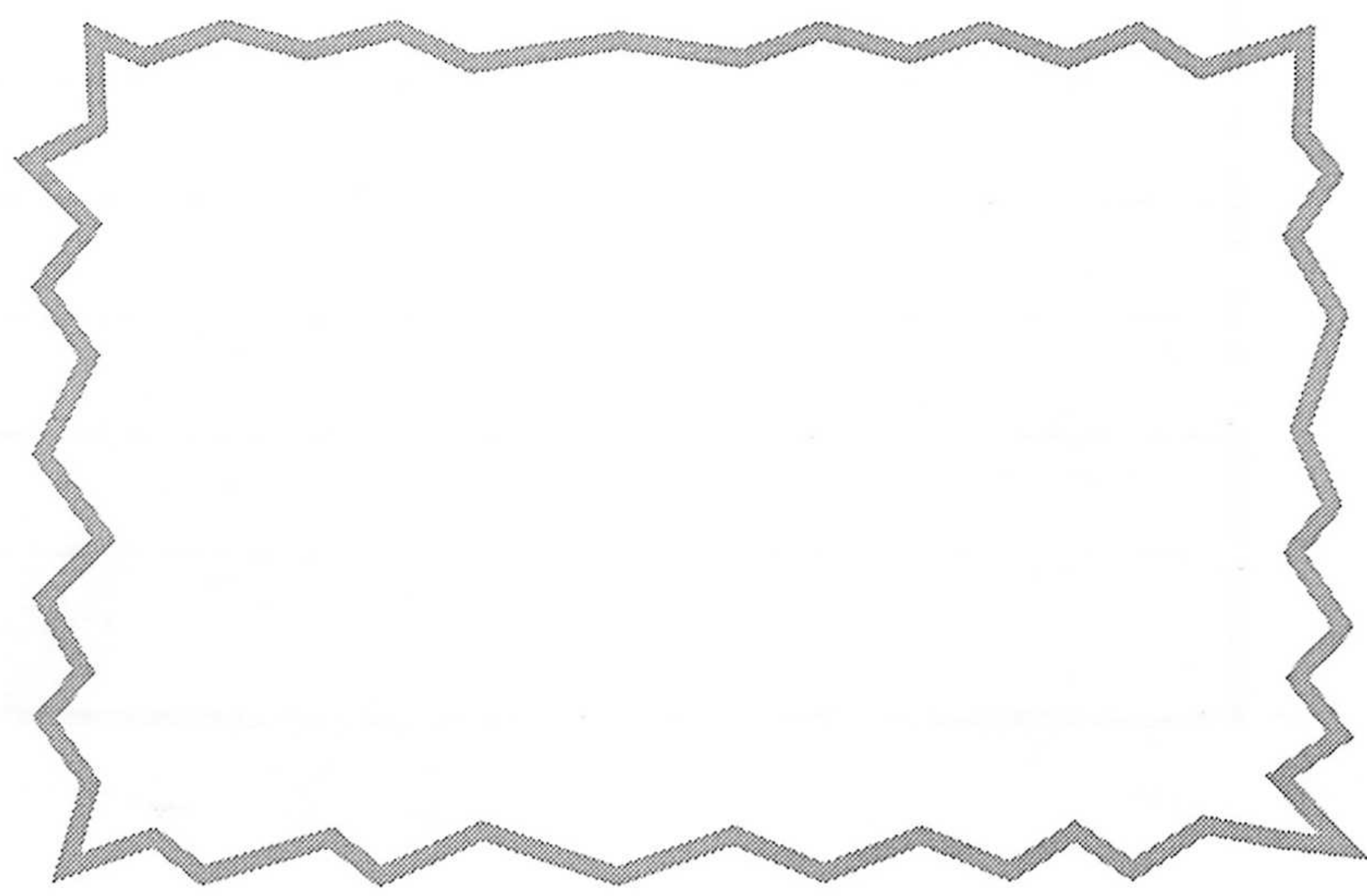

- Ri tijonel nusöl rub'eyal jujun samaj.
- Ri tijoxela' nkitz'ib'aj pa kisik'iwuj jujun samaj.

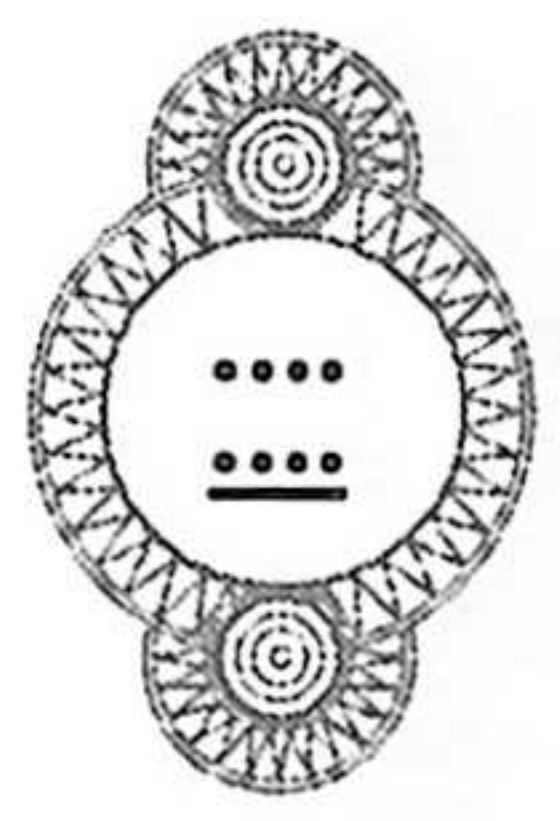

Tqaqupij pa taq taluwuj ri samaj tikirel nqab'än töq ri'j ik' k'a ri yeqatz'arab'a' chuwäch qasik'iwuj.

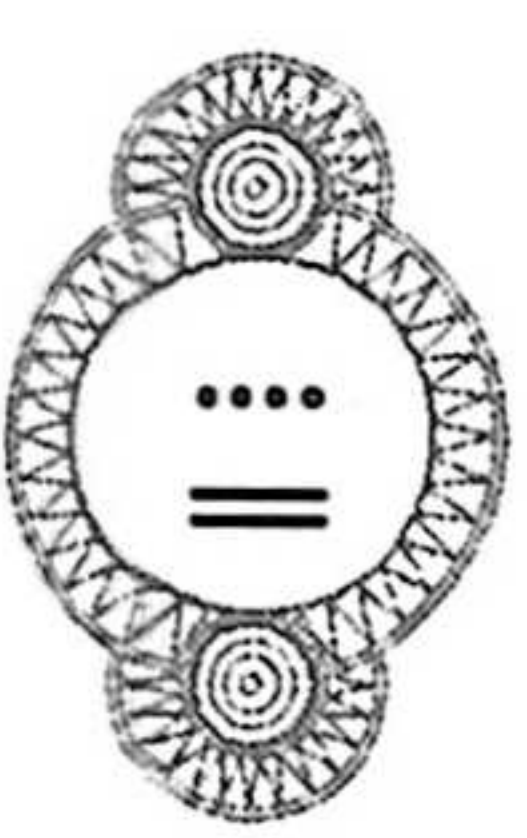

Tqakanoj jun ti lema' ri ntzizon pa ruwi' ri qati't ik'.

- Ri tijonel nusöl rub'eyal jujun samaj.
- Ri tijoxela' nkiqupij taq achib'äl pa ruwi' ri kisamaj xkib'än.





Tqetamaj ruwäch ri qati't ik'

¿Awetaman rat chi ri qati't qamama' xketamaj xkik'waj rub'eyal kik'aslem rik'in ri qati't ik'?

Ri qati't ik

Qati't qati't, at k'o pa qawi'

Qati't qati't, rat ri at qati't'

Qati't wawe', qati't, ke la'

Qati't qati't, at k'o pa qawi'

Qati't qati't, yatxule' yatjote'

Nkikot ri nata', nkikot ri nute'

nak'ut awi' , nak'ut ri b'ey töq

nb'an ri b'enan ke la' pa juyu'

Qati't qati't, loq'oläj qati't

Nim awejqalem pa qak'aslem

Wi rat at k'o, majun k'ayewal

ri'j ik', yojchala' chawe.

Tz'ib'anel: Ambrocia Cuma

Kojb'ixan qonojel

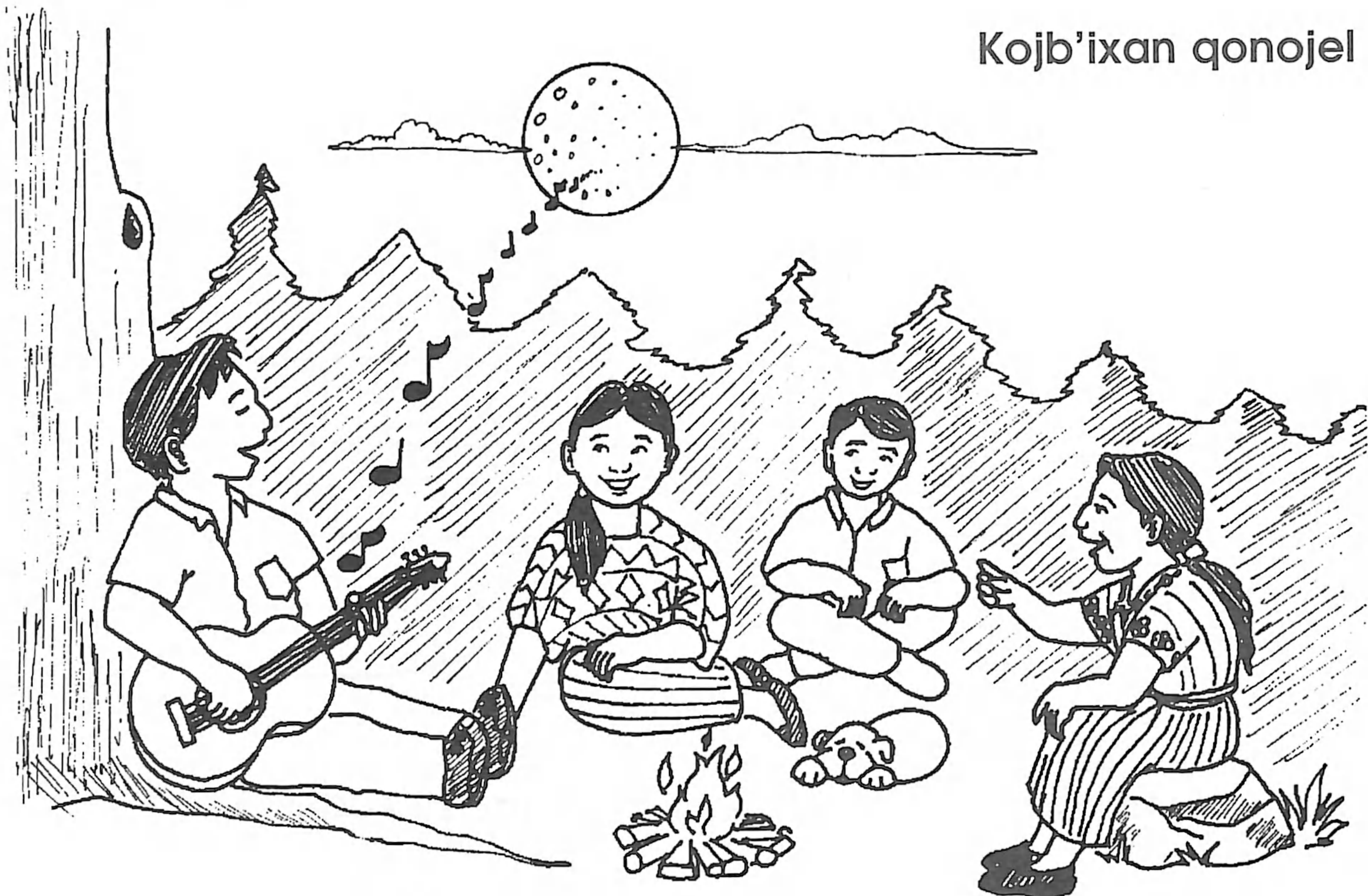

Tqasik'ij ri b'ix, k'a ri' pa molaj tqakanoj rub'eyal nqab'ixaj re jun b'ix re', we k'o jun chik qana'oj tqatz'aqatisaj ri b'ix, k'a ri' tqab'ixaj kik'in ri qachib'll.



Tqasolo' chuqa' tqatz'ib'aj achike ruma nqab'ij qati't ik' chi re.



A large rectangular box with horizontal lines for writing, containing an illustration of a pen nib.

Tqatz'ib'aj jun pach'un tzij chi kij ri ik' chuqa' ri q'ij.

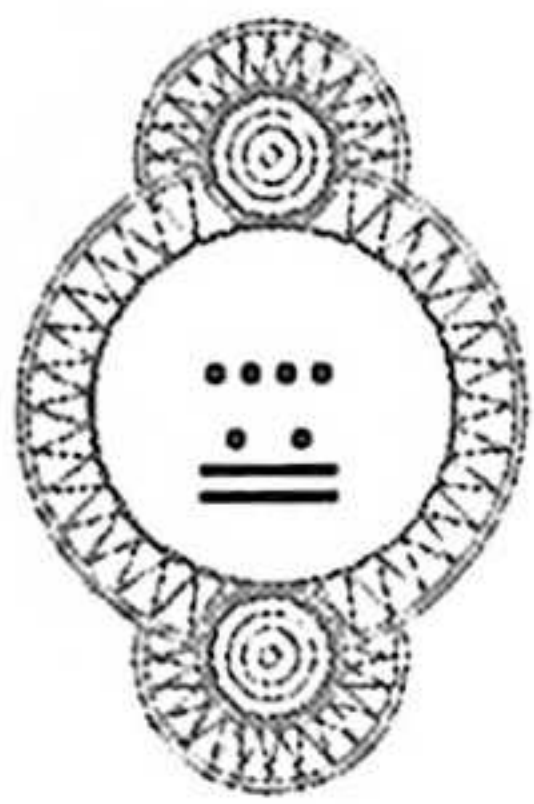

Pa ruwi' ri ik'

Pa ruwi' ri q'ij

A circular writing area with horizontal lines and a faint crescent moon background.

A circular writing area with horizontal lines and a faint sun background.

Tqasik'ij chi kiwäch ri qachib'il ri pach'un tzij xqatz'ib'aj.



- Ri tijonel nusöl el rub'eyal ri k'utunik nkib'än pe chi kochoch ri ak'wala'.
•• Ri tijoxela' nkitz'ib'aj ka'i' pach'un tzij chi kipam la taq setesäq.

RUWAQXAQ TANAJ

Ruxe'el ri Cholq'ij

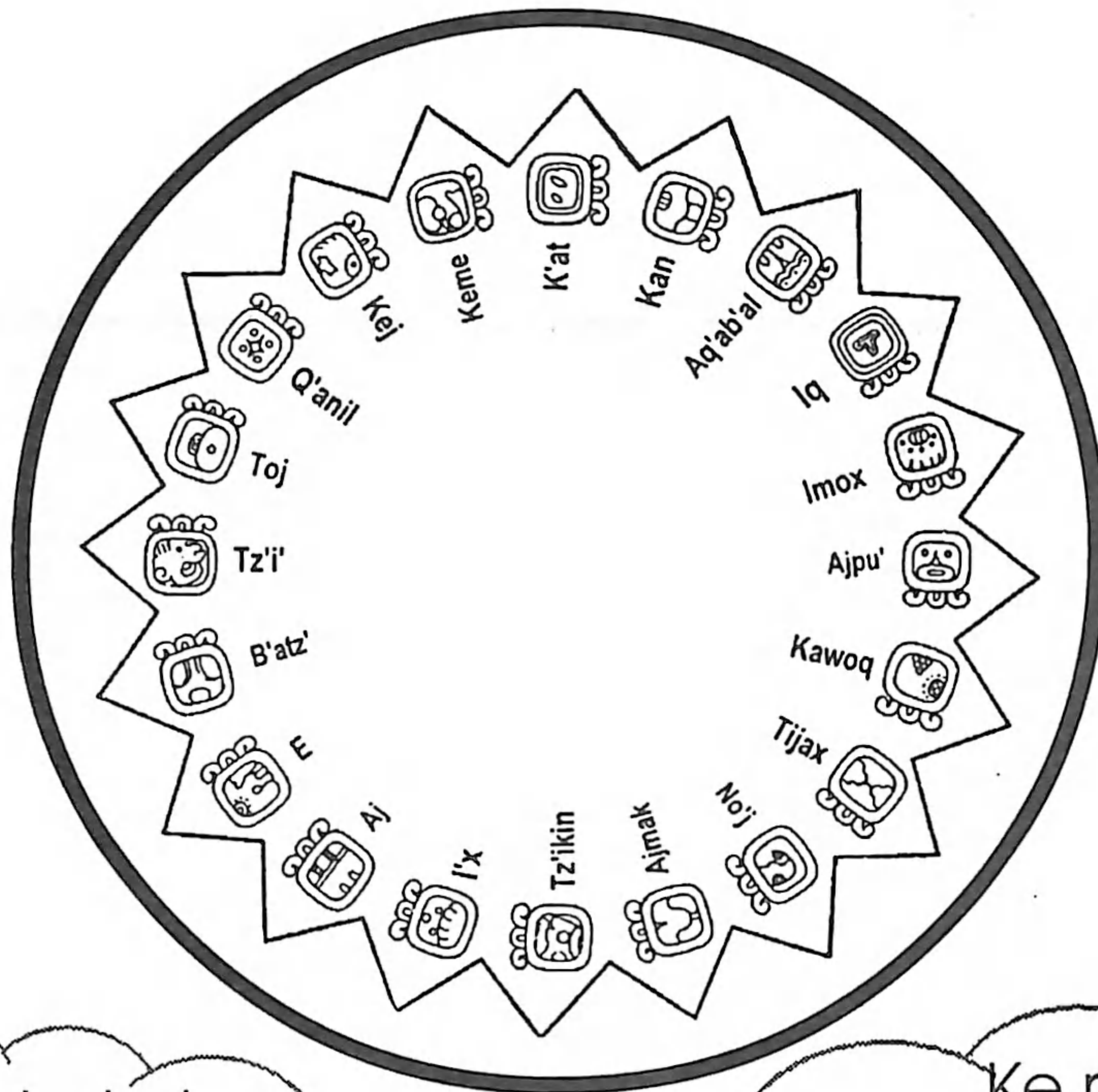

¿Rat Ixchel
Juk'al q'ij e k'o
chupam ri cholq'ij?

Ke ri' Ajpu',
Ri qati't qamama' nkib'ij
chi oxlajuj mul yeq'ax jujun
q'ij chupam jun juna'



Ri etamanik nuq'i' ri tijoxel:
Nretamaj kiwäch ri jujun q'ij
Nretamaj kib'i' jujun q'ij
Nuya' rejqalem ri jujun q'ij pa ruk'aslem





Jarupe' kiwäch cholq'ij e k'o



Tqatzijoj achike cholq'ij ye'okisäx wakami.
Tqatz'ib'aj ri na'oj xqetamaj.

A large rectangular box with a thick border and four horizontal lines inside, intended for writing.

Tqab'ana kachib'äl ri cholq'ij xeqatzijoj

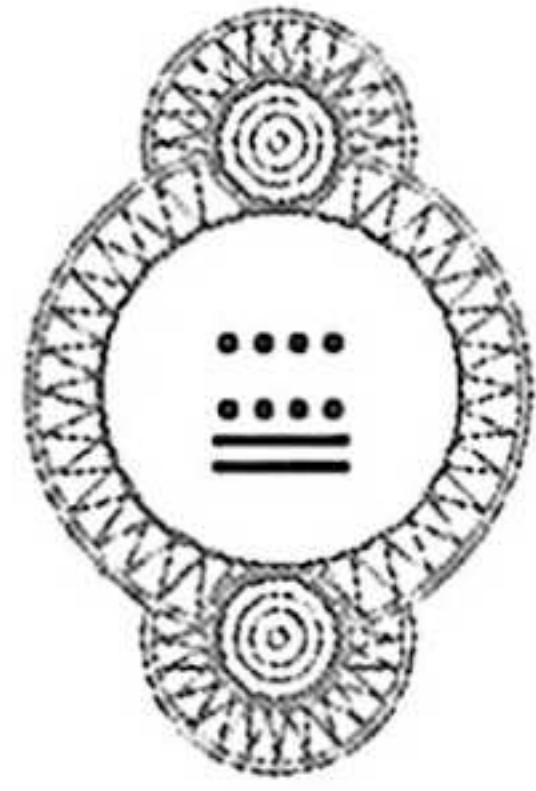

A rounded rectangular box with a thick border, intended for drawing or writing.

A rounded rectangular box with a thick border, identical to the one on the left, intended for drawing or writing.

Tqatz'ib'aj achike kikojolil xeqil.



A large rectangular box with a thick border and three horizontal lines inside, intended for writing.

• Ri fijonel nusöl rub'eyal ri rejqalem kisamajixik ri cholq'ij.
•• Ri tijoxela' nkitzijoj achike ri nb'ix cholq'ij chi re. Chuqa' nkitz'ib'aj ri na'oj xkitzijoj.



Ri Maya' Cholq'ij

Ri maya' cholq'ij yerokisaj juk'al q'ij, pa jun juna' yeq'ax oxlajuj mul richin nb'etz'aqät oxlajk'al q'ij.

Pa molaj tqatz'aqatisaj ri kib'i' chuqa' ri kachib'äl ri maya' cholq'ij.

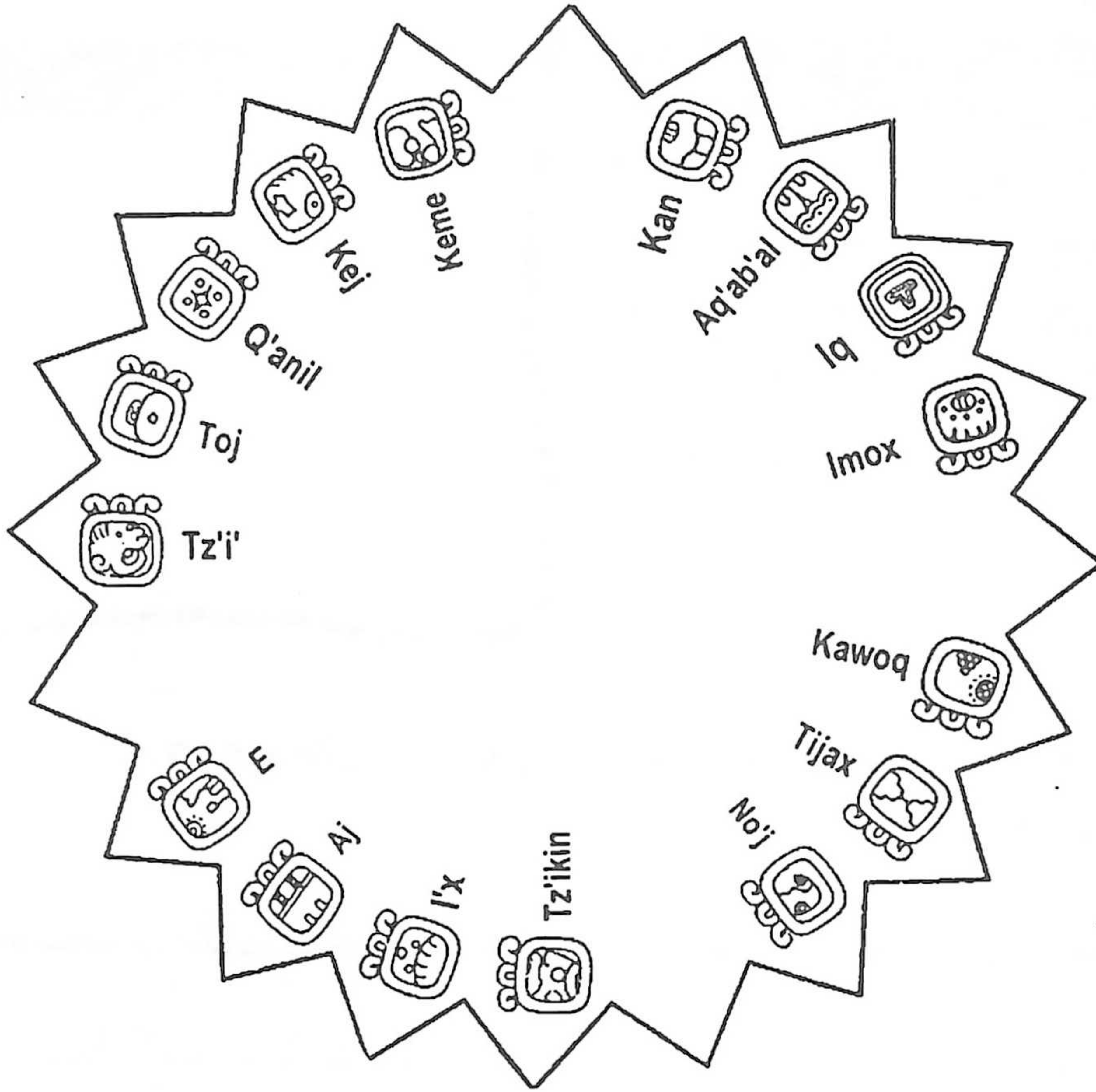

Tqatz'ib'aj jun pach'un tzij pa ruwi' ri cholq'ij.

- Ri tijonel nusöl achike ri' ri maya' cholq'ij.
- .. Ri tijoxela' nkitz'aqatisaj ri kib'i' chuqa' ri kachib'äl.
- ... Töq nkik'is nkitz'ib'aj jun pach'un tzij.



Rejqalem ri rusolik ri cholq'ij

Pa maya' na'oj, ri cholq'ij, nım rejqaalem pa ruk'aslem ri winäq. Ruma ri' ronojel winäq k'o chi retaman achike q'ij xaläx pa maya' cholq'ij; rik'in k'a re na'oj re', tikirel nutz'ët nretamaj achike samaj tikirel nub'än pa ruk'aslem. rik'in jub'a, tzijon chi qe chi man ütztari na'oj pa ruwi' ri ak'aslemal, ri man qitzijta, rik'in re ka'i' oxi' na'oj re' tikirel nak'waj pa rub'eyal ri ak'aslem chuwa'q kab'ij apo.

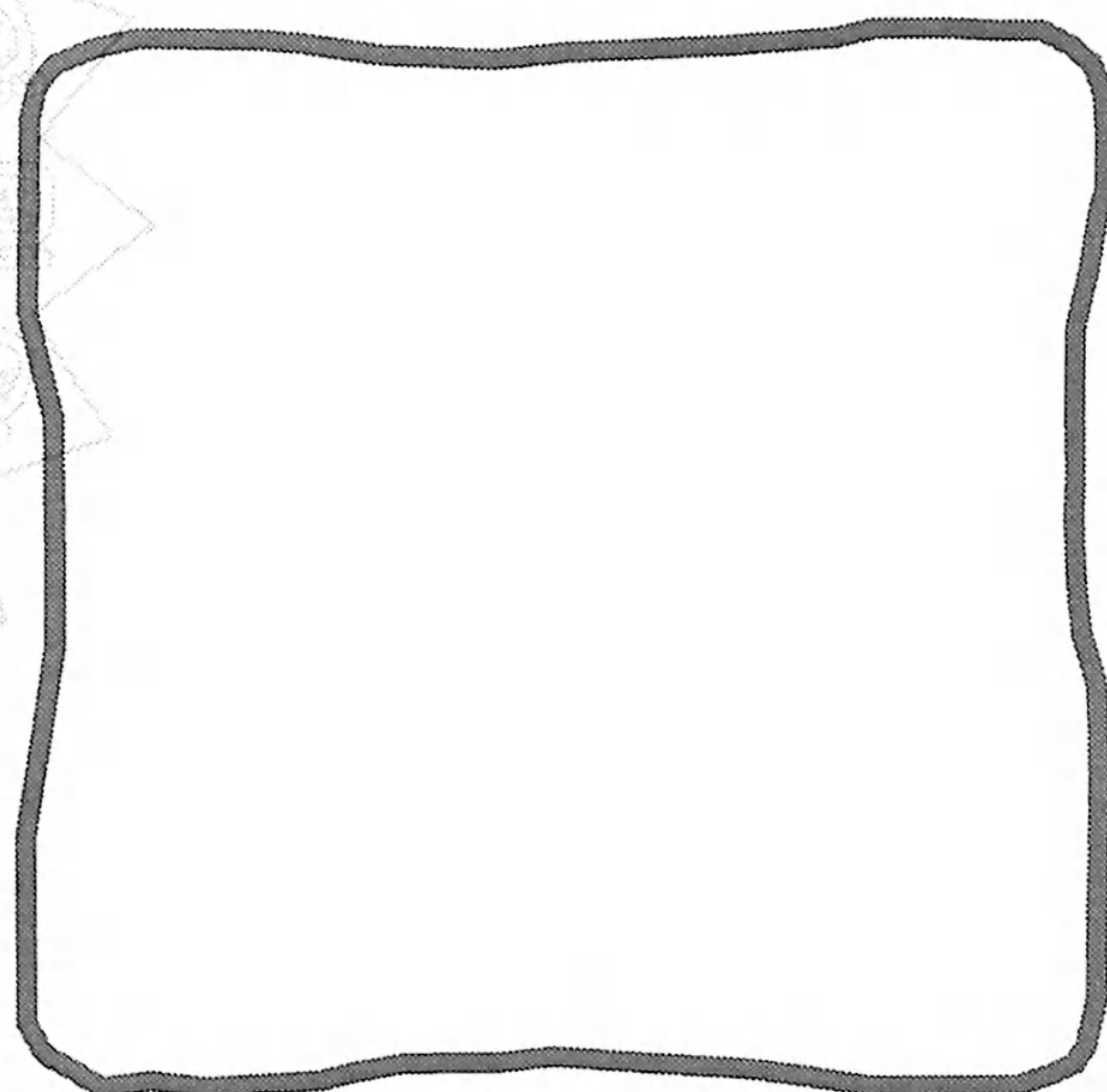

Tqatz'ib'aj pa qasik'iwuj achike q'ij yeqil chupam re jun kajtz'uk re'.

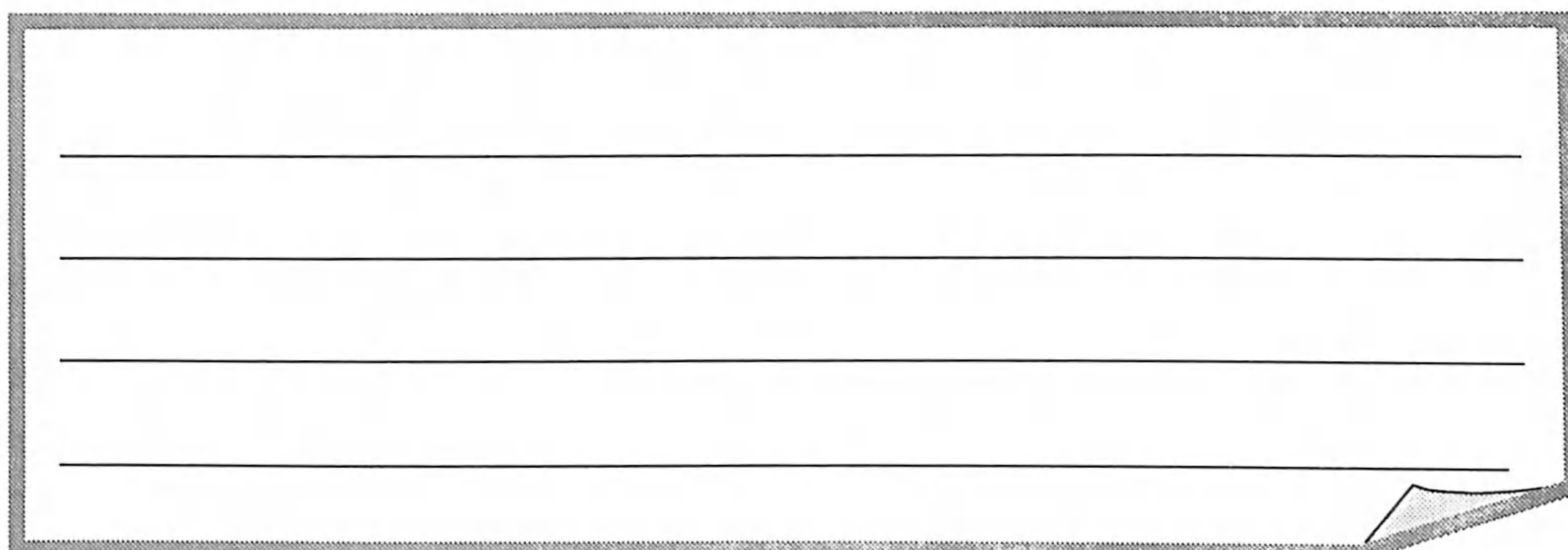

Rik'in re na'oj re' nqatz'ët chi ri ojer qati't qamama' kan xkitaqej rokisaxik ri maya' cholq'ij.

- Ri tijoxela' nkisik'ij ri na'oj tz'ib'atäl kan.
- .. Ri tijonel nutz'aqatisaj ri jun na'oj chi ke ri tijoxela'.
- ... Ri tijoxela' nkitz'aqatisaj ri na'oj nuk'utuj ri jun k'utunik.



Ri nkiq'ajuj ri jujun q'ij pa maya' cholq'ij.

Tqetamaj ri nuq'ajuj ri jujun q'ij pa ruk'aslem ri winäq.

Ri retamaxik ri nuq'ajuj ri jun q'ij pa maya' cholq'ij, yatruoto' richin nakanoj ato'ik chuqa' richin yatikir nanimirisaj ri na'oj.

Q'ij	Ri nuq'ajuj
B'atz'	Re tzij re', petenäq chi rij re tzij b'atz'oj. Re q'ij re' ruk'amon yeb'atz' yexim ri na'oj pa ruwi' jun samaj.
E	Re' nuq'ajuj ri qab'ey. Chupam re q'ij re' tikirel nqakanoj rub'eyal jun qasamaj jun qana'oj.
Aj	Re' nuq'ajuj kiq'ij ri ak'wala'. Chupam re q'ij re' tikirel natz'uk el rutikik awochoch. Chuqa' ützt richin yamatyoxin.
B'alam	Chuqa' nb'ix b'alam chi re'. Re q'ij re' ruk'amon richin nqamatyoxij ronojel ri nusipaj ri ruwachulew chi qe.
Tz'ikin	Nuq'ajuj ajxik chikop. Re rajawal ri b'eyomäl chuqa' kinawal ri b'ixanela' ri kelonela'.

Q'ij	Ri nuq'ajuj
Ajmaq	Kiq'ij ri kaminaqi'. Re q'ij re' k'amonel richin yeqanataj ri qati't qamama'. Ri ye'aläx re q'ij re' e ch'ob'onela'.
No'j	Ja ri' ri rajawal ri na'oj, ri ch'ob'onik. ruk'amon nqamatyoxij ronojel ri na'oj qak'ulun pe richin nqokisaj pa rub'eyal.
Tijax	Ja ri', ri qëq chay xokisäx richin ch'ayob'äl. Re q'ij re' tikirel nqak'utuj chi re ri Ajaw richin nrelesaj ri etzelanik chi qij.
Kawoq	Re q'ij re' tikirel nak'utuj utziläj na'oj richin natz'ët chi näj chi naqaj chuqa' kinawal ri e k'exelom.
Ajpu'	Ja ri', ri qatata' q'ij. Kinawal ri ajtiko'n chuqa' ri b'ixanela'. Re q'ij re' ützt nqak'utuj richin manaq kamik.





Q'ij	Ri nuq'ajuj
Imox	Kinawal ri: jäb', palow, choy. Ütz richin nak'utuj ana'oj. Tikirel ye'aq'omäx ri k'o ruyab'il kijolom.
Iq'	Ja ri', ri kaq'iq. Ütz nak'utuj richin nelesäx ronojel etzelanik.
Aq'ab'al	Nuq'ajuj ri nab'ey taq rusaqil ri q'ij. Jun q'ij richin nqak'utuj saqil pa ruwi' ri qasamaj ri qana'oj.
K'at	Retal ri kisamajib'al ri yekarun. Runawal ri kajulew ri ruwachib'äl ja ri', ri Q'uaq'kumätz. Jun q'ij richin nakanoj awachib'il richin jun samaj.
Kan	Nuq'ajuj ri k'an, nuq'ajuj ri uxlanib'äl k'u'x. K'atzinel nqachajij ri qatzij we man ke ta ri' nqab'än xa nuya' k'ayewal.

Q'ij	Ri nuq'ajuj
Keme	Runawalil ri kamik. Jun q'ij richin kaq'omaxik konojel yawa'i'. Yalan nim ruchuq'a' pa ruwi' ri kamik chuqa' ri k'aslem.
Kej	Ojer kan ja ri', ri masat. Kinawalil ri nab'ey taq kaji' qati't qamama'.
Q'anil	Runawal ri ija'tz ri tiko'n chuqa' ri alanik.
Toj	Q'ij richin nb'an tojik. Runawal ri loq'oläj q'aaq'. Jun q'ij richin yematyoxin pa ruwi' ronojel.
Tz'i'	Kinawal ri q'atb'äl taq tzij. Kinawal ri winaqi' nkikanoj ruchojmilal ri k'aslem.

. Tikirel nkisik'ij ri jujun q'ij.
 .. Ri tijonel nutz'aqatisaj ri jun na'oj pa kiwi' ri jujun q'ij.



Ri nimaq'ij pa Maya' Na'oj

Pa maya' na'oj e k'o jujun q'ij ri yalan k'o kejqalem.
Ruma ri qati't qamama' ketaman achike nuq'ajuj ri
jujun q'ij, ri je' xkiyala' retal re q'ij richin jun b'anob'äl.

Tqak'utuj, tqakanoj chuqa' tqatz'ib'aj
achike q'ij ri k'o nim kejqalem pa maya' b'anob'äl.

Tz'eteb'äl:

Ri Waqxaqi' B'atz: Chupam re q'ij re' nkik'ul
kipatan samaj ri ajaq'ija'.



Blank writing box with horizontal lines.

Blank writing box with horizontal lines.

Blank writing box with horizontal lines.

Blank writing box with horizontal lines.

Blank writing box with horizontal lines.

Blank writing box with horizontal lines.

- Ri tijonel nutzijoj chi kiwäch ri tijoxela' rejqalem ri nima'q taq q'ij pa maya' b'anob'äl
- Ri tijoxela' nkikanoj ri nima'q taq q'ij chupam ri Maya' Cholq'ij.



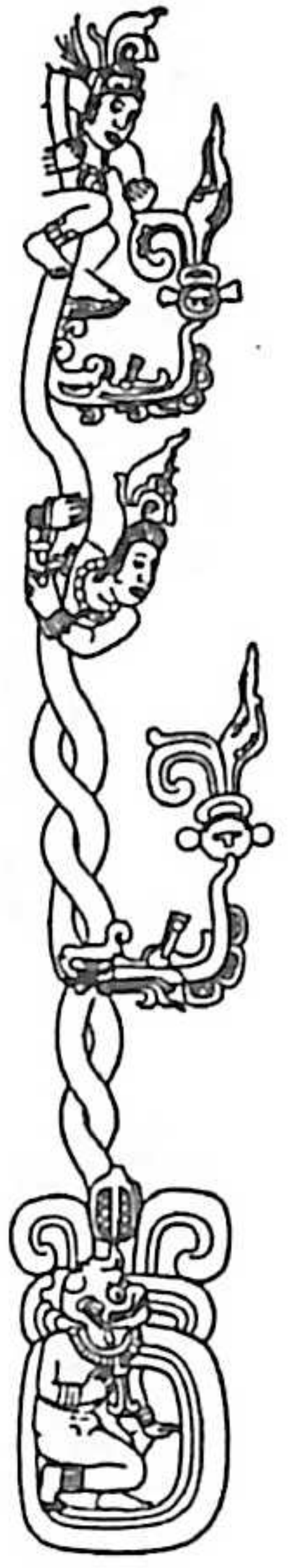

Ri patan samaj ruximon ri', rik'in ri cholq'ij.



Pa maya' na'oj, konojel winaqi' k'o jun patan kismaj. Re samaj re', ja ri' ri samaj ri man xa b'a achike ta nb'ano. Nel chi tzij chi re patan samaj re, kan ruk'amon pe pa ralaxik ri winäq.

Tz'eteb'äl:

1 Ri k'exelon: Ja ri' ri jun nan ri yeruk'ul apo ri taq ne'y. Re etamabäl re', kan ruyon nunuk' el ri' pa ruk'aslem.

1 Tqakanoj kib'i' chuqa' kib'anikil ch'aaq chik patan samaj. Re na'oj re' ütznqak'utuj chi ke qate' qatata', we k'a te man ketaman ta ri je' ütznqak'utuj chi ke juley chik winaqi'.

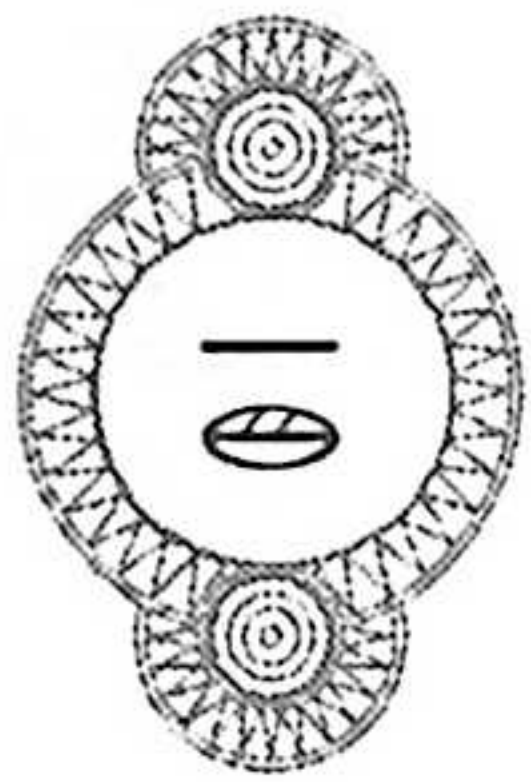

A large rectangular box with a thick border, containing five horizontal lines for writing.

Ri xkeqil ruk'amon nqatzijoj chi ke ri qachib'il ri e k'o pa tijonijay. Tikirel nqokisaj re k'utunik re'.

¿Achike nk'atzin wi nqetamaj kib'i' kib'anikil ri patan samaj?

Kejqalem ri winaqi' k'o jun patan kismaj.

Tqatz'ib'aj pa qasik'iwuj ronojel ri na'oj xqatzijoj xqak'axaj.



- Ri tijonel nutzijoj chi kiwäch ri tijoxela' rejqalem ri patan samaj chuqa' ri jun tz'eteb'äl.
- Ri tijoxela' nkikanoj, nkitz'ib'aj jarupe' kiwäch patan samaj e k'o; chuqa' nkitzijoj chi kiwäch ri kachib'il.



Ri maya' cholq'ij

Tqatz'ib'aj jarupe' kiwäch cholq'ij ye'okisäx wakami.

Large rectangular writing area with horizontal lines for text.

Ri maya' Cholq'ij e k'o juk'al q'ij chupam.

Jarupe' mul yeq'ax ri jun juna'.

Achike q'ij xataläx pa maya' Cholq'ij. Tak'utuj chi re ri atijonel ri rub'eyal nawil ri q'ij ri'.

Rik'in ronojel ri na'oj awetaman pa ruwi' ri Cholq'ij, tatz'ib'aj xa b'a achike chi ke re na'oj re': jun b'ix, jun lema', jun pixa', jun pach'un tzij.

Large irregularly shaped writing area with horizontal lines for text.

Ri tijonel xa xe nusöl chi kiwäch ri tijoxela' ri rub'eyal ri jujun na'oj.
Ri tijonel k'o chi k'o jun rusamajib'al pa ruwi' ri rillixik ri a...
Ri tijoxela' nkib'an jun tz'ib'anik.



Ri k'ak'a' na'oj xinwetamaj pa ruwi' ri Cholq'ij



Achike ri', ri maya' Cholq'ij.

Jarupe' q'ij yerokisaj ri maya' Cholq'ij.

Tqatzijoj chi ke qach'alal pa qochoch ri rejqalem ri Cholq'ij.

Tqatz'ib'aj ri nuq'ajuj ri q'ij xojaläx pa Maya' Cholq'ij.

Ri tijoxela' nkiya' kina'oj pa ruwi' ri nk'utux chi ke.

RUB'ELEJ TANAJ

Ri Maya' Ajilab'äl

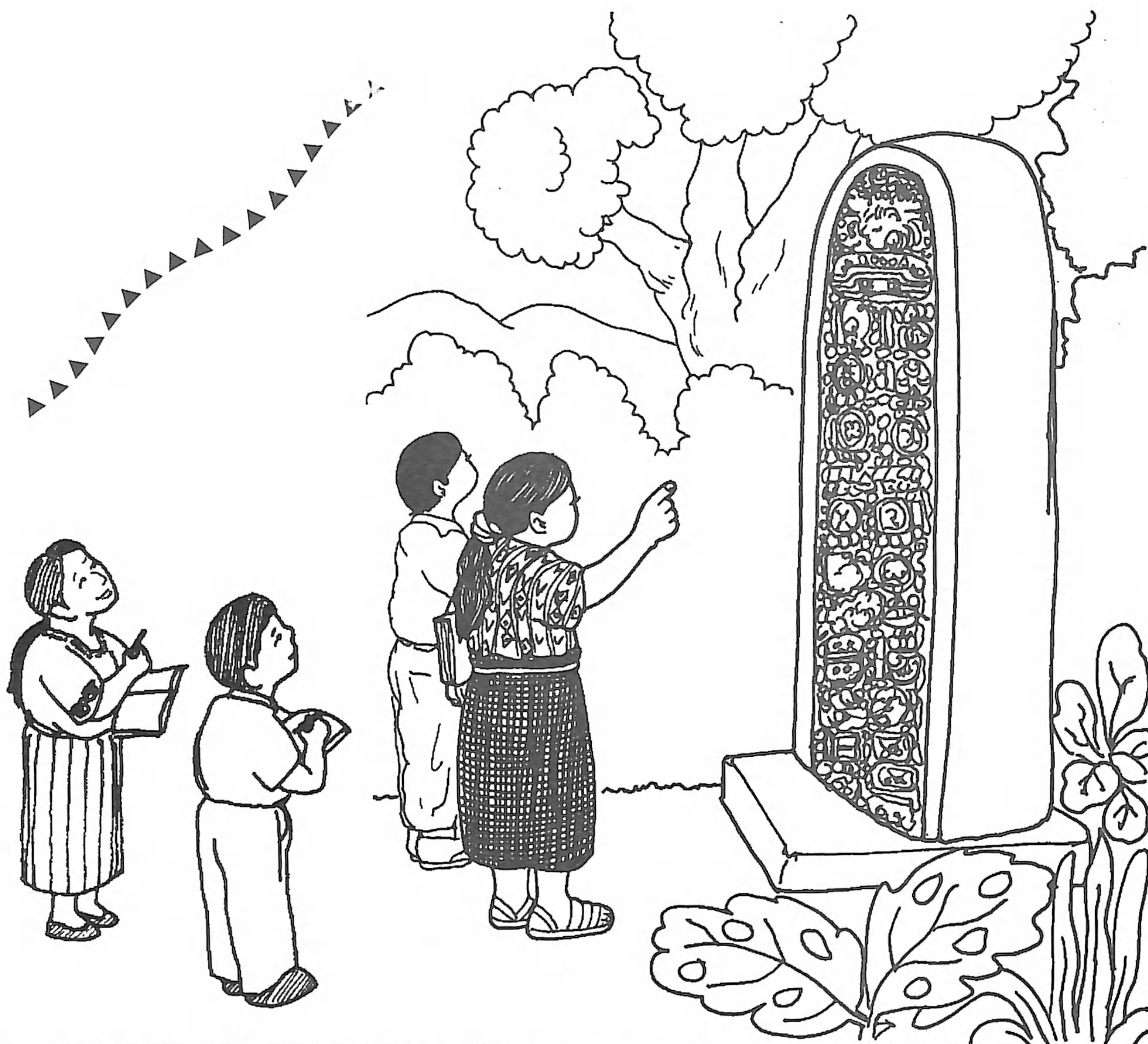

Ri etamanik nuq'i' ri tijoxel:

Nusöl pa rub'eyal ri maya' ajilab'äl
Nutz'ib'aj ri maya' ajilab'äl juk'al k'a b'elejlajk'al b'elejlajuj.
Nrokisaj pa rub'eyal cholajilanik pa maya'.
Nrokisaj pa rub'eyal ri jujun maya' etab'äl.

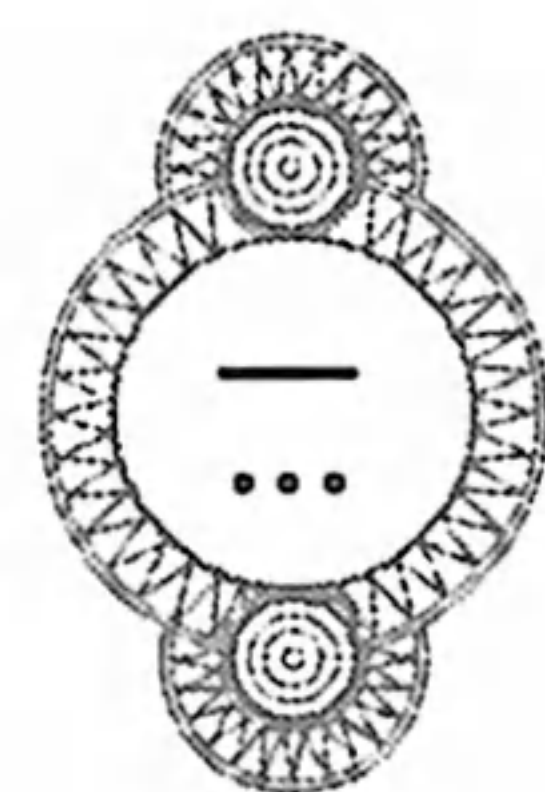

Rejqalem ri Maya' Ajilab'äl

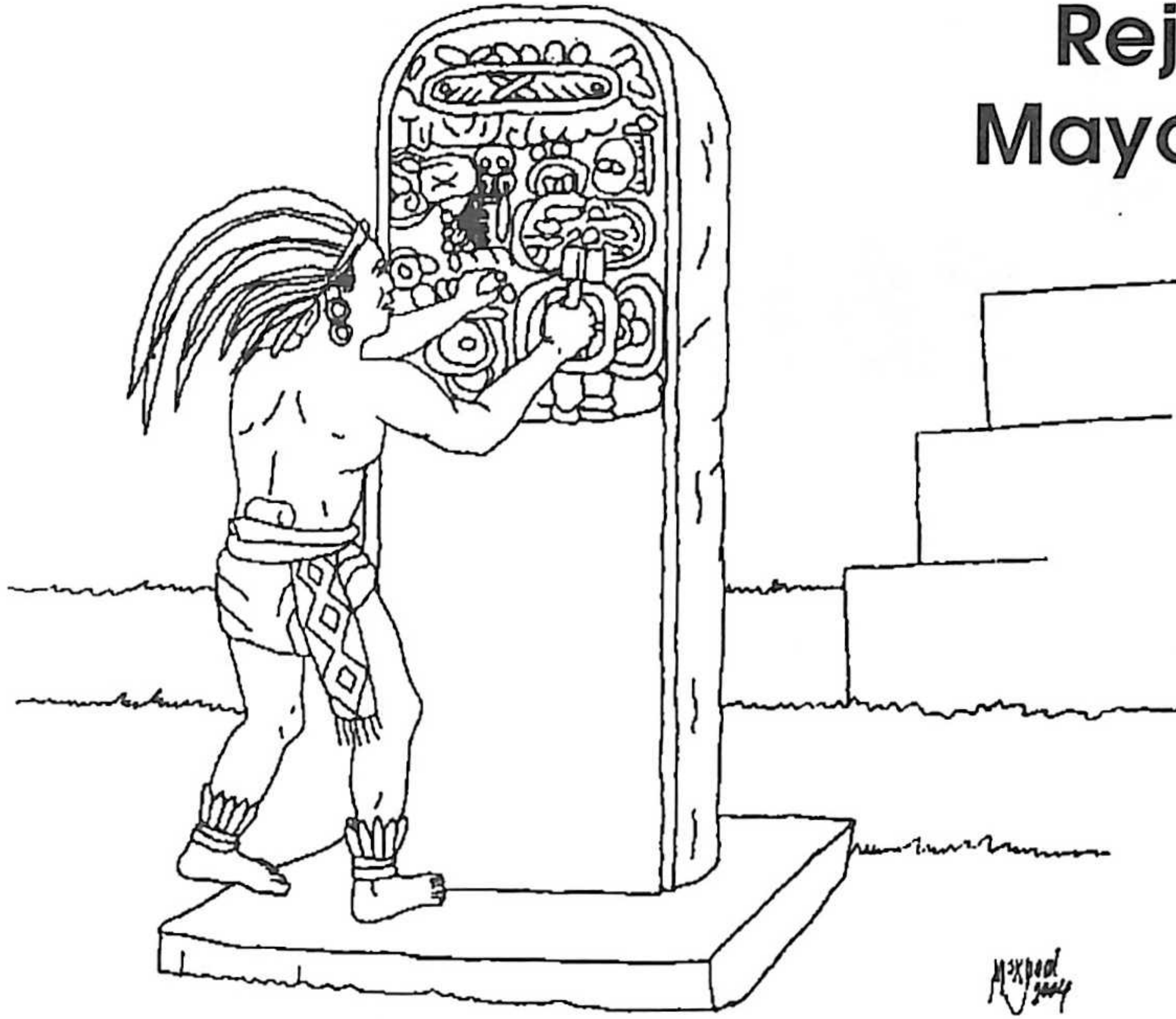

Pa molaj tqatzijoj tqatz'ib'aj ri rub'eyal xkitz'ib'aj ri maya' ajilab'äl ri ojer tati't qamama'.

Tqak'utuj chi ke ri qate' qatata', k'a pa jarupe' ye'ajilan. Nqatz'ib'aj pe achi'el xkib'ij pe chi qe.

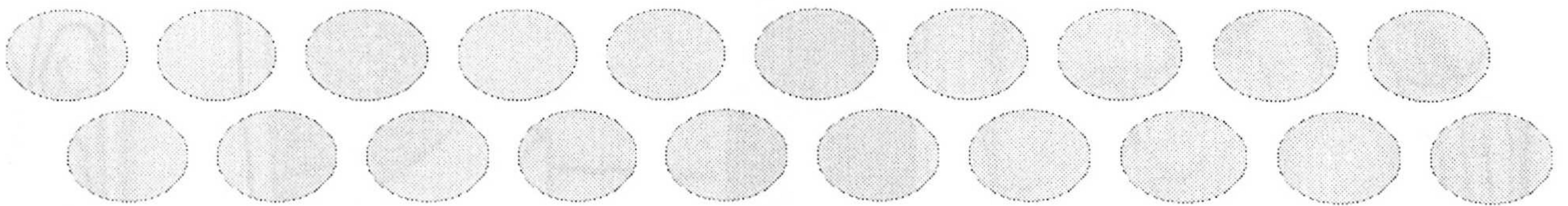

Tqatzijoj chi kiwäch ri qachib'il, achike ketamab'al ri qate' qatata' pa ruwi' ri maya' ajilab'äl.

- . Ri tijoxela' nkib'ixaj re jun b'ix rub'i' «Ajilanik», ruchojmirisan ri FUNKAQ.
- .. Ri tijonel yerunuk' pa molaj ri tijoxela' richin nkib'än ri kisamaj.
- ... Yech'ob'on pa ruwi' ri maya' ajilanik nllitäj chuwäch ri jun tz'aq.
- Ri tijoxela' yekik'ulb'ej ri kite' kitata', pa ruwi' ri maya' ajilab'äl.



Nab'ey taq na'oj pa ruwi' ri maya' ajilab'äl

Ri maya' ajilab'äl, xa xe nrokisaj oxi' taq achib'äl.

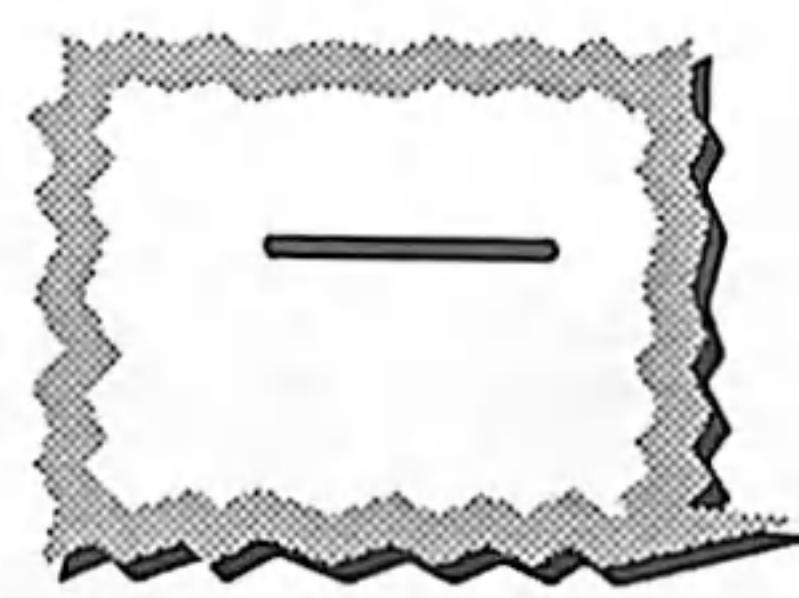
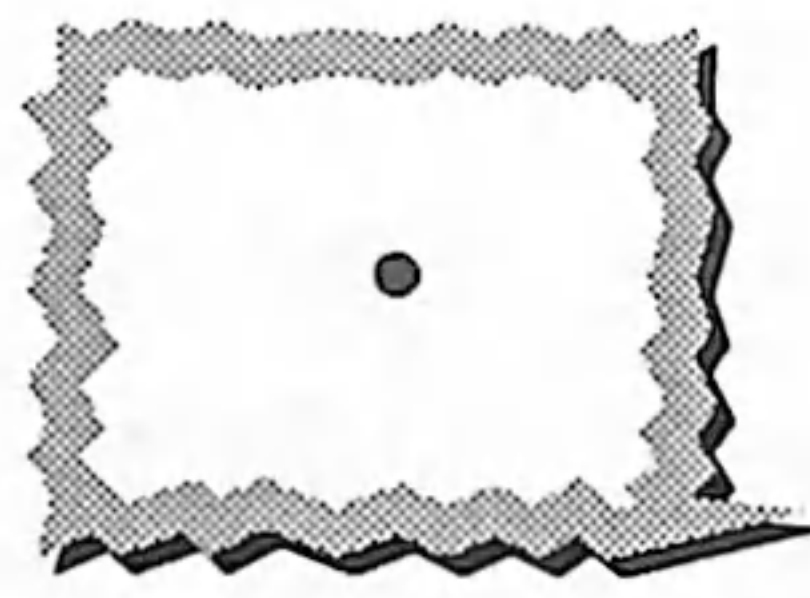
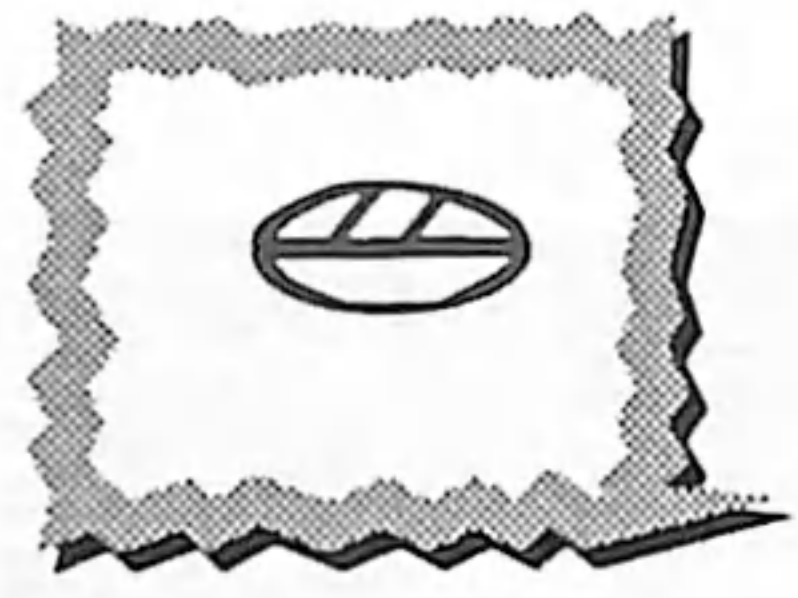

Ri Wa'ix =

Ri Tz'uj

Ri Juch'

Rik'in re oxi' achib'äl re' tikirel nqatz'ib'aj xa b'a achike ajilab'äl.

Ri taq tz'uj xa xe tikirel nqokisaj kaji' mul.

Ri juch' xa xe tikirel nqokisaj oxi' mul ri nkitelela' ki'.

Tqatz'ib'aj jujun tz'eteb'äl pa ruwi' ri maya' ajilab'äl, wa'ix k'a b'elejlajuj, chi re ri nab'ey xak

Maya' tz'ib'axik	Pa qach'ab'äl	Pa kaxlan tz'ib'anik
	Wa'ix	0
	Jun	1
	Wo'o'	5
	Lajuj	10
	Wolajuj	15
	B'elejlajuj	19

Tqatz'ib'aj wo'o' b'ab' akuchi nqokisaj ri maya' ajilab'äl.

• Ri tijonel nusöl chi kiwäch ri tijoxela' achike runuk'ik ri ruxe'el ri maya' ajilab'äl.
 .. Ri tijoxela' nkitz'ib'aj wo'o' taq b'ab' pa ruwi' ri maya' ajilab'äl.

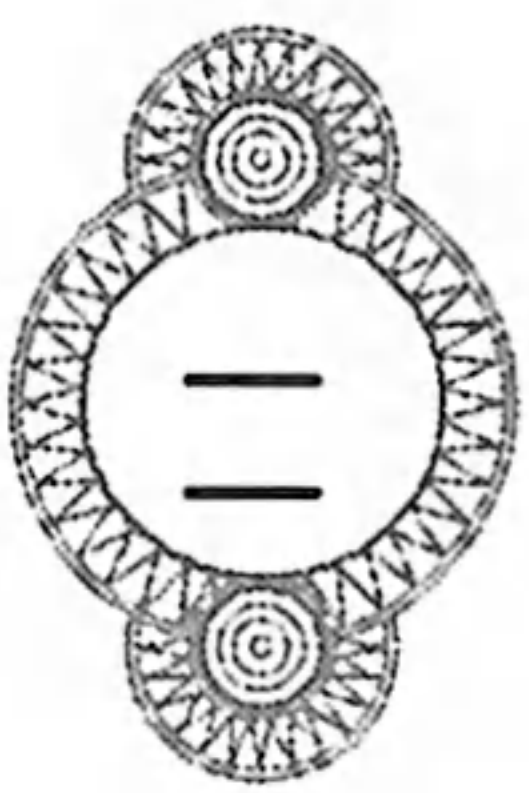

Nab'ey peraj pa ruwi' rokisaxik ri ruka'n xak



Tqatz'ib'aj ri ajilanik pa ruwi' ri jun peraj chi re ri ruka'n xak, nqatikirisaj el juk'al k'a juk'al b'elejlajuj.

Maya' Tz'ib'axik	Pa qach'ab'äl	Pa Kaxlan ch'ab'äl
☉	Juk'al	Juwinäq 20
	Juk'al jun	Jun rukak'al 21
	Juk'al ka'i'	Ka'i' rukak'al 22
	Juk'al oxi'	Oxi' rukak'al 23
	Juk'al kaji'	Kaji' rukak'al 24
	Juk'al wo'o'	Wo'o' rukak'al 25
	Juk'al waqi'	Waqi' rukak'al 26
	Juk'al wuqu'	Wuqu' rukak'al 27
	Juk'al waqxaqi'	Waqxaqi' rukak'al 28
	Juk'al b'eleje'	B'eleje' rukak'al 29
	Juk'al lajuj	Lajuj rukak'al 30
	Juk'al julajuj	Julajuj rukak'al 31
	Juk'al kab'lajuj	Kab'lajuj rukak'al 32
	Juk'al oxlajuj	Oxlajuj rukak'al 33
	Juk'al kajlajuj	Kajlajuj rukak'al 34
	Juk'al wolajuj	Wolajuj rukak'al 35
	Juk'al waqlajuj	Waqlajuj rukak'al 36
	Juk'al wuqlajuj	Wuqlajuj rukak'al 37
	Juk'al waqxaqlajuj	Waqxaqlajuj rukak'al 38
	Juk'al b'elejlajuj	B'elejlajuj rukak'al 39

Ri maya' ajilab'äl yerokisaj ri taq etal chuqa' k'o rub'ixik pa qach'ab'äl. Wakami tikirel nqab'ij chi ka'i' rub'ixik, jun ri ntz'aqatisäx ri jun chik ntzolin pe chi rij.

- Ri tijonel nusöl chi kiwäch ri tijoxela' rokisaxik ri nab'ey peraj ri ajilanik .
- Ri tijoxela' nkich'ob' runuk'ik rub'anon ri kokoj ruxak' ri ajilanik.



K'atzinel jeb'ël nqatzu' ri rokisaxik ri
ajilab'äl kak'al k'a b'elejlajk'al b'elejlajuj

Maya' ajilanik	Rub'ixik pa qach'ab'äl	Pa Kaxlan ch'ab'äl
-------------------	------------------------------	--------------------------

	Kak'al	40
	Oxk'al	60
	Kajk'al	80
	Wok'al	100
	Waqk'al	120
	Wuqk'al	140
	Waqxaqk'al	160
	B'elejk'al	180
	Lajk'al	200
	Julajk'al	220

Maya' ajilanik	Rub'ixik pa qach'ab'äl	Pa Kaxlan ch'ab'äl
-------------------	------------------------------	--------------------------

	Kab'lajk'al	240
	Oxlajk'al	260
	Kajlajk'al	280
	Wolajk'al	300
	Waq'lajk'al	320
	Wuq'lajk'al	340
	Waqxaq'lajk'al	360
	B'elejlajk'al	380
	B'elejlajk'al	
	b'elejlajuj	399

Tqak'utuj chi ke ri tijonela', e jarupe' ak'wala'
tz'ib'an kib'i' pa jujun tijonijay, tqamolo' ruchi', ka
ri' nqatz'ib'aj pa qatz'ib'awuj.

- .. Ri tijonel nusol achike rub'eyal runuk'un ri' ri ajilab'äl.
- .. Ri tijoxela' nkitz'aqatisaj pa kitz'ib'awuj ri maya' ajilab'äl.



Ruxe'el ri maya' ajilab'äl



Ri maya' tinamit, jantape' rokisan pe ajilab'äl richin nutz'ët ronojel ri k'o pa kajulew. Ri rub'eyal ri ajilab'äl rokisan pe, ja ri juk'al ruxe'el. Re na'oj re' nub'ij chi man junam ta rik'in ri kaxlan ajilab'äl ja ri lajuj ruxe'el. Ri ojer kan ri', kokisan pe achib'äl richin ye'ajilan. Tqatz'eta na jun ka'i' oxi'.



Wa'ix



jun



wo'o'



lajuj



wolajuj



b'elejlajuj

Ri ojer qati't qamama' chuqa' xekokisaj rachib'äl ri pur, ri taq tz'uj chuqa' ri taq juch'. Rik'in k'a re etal re', xekinuk', xkitz'et ruramaj ri jujun b'anob'äl xekiq'axala' kan. Xa ja k'a töq xepe ri kaxlani' chi rujalik ri rutz'ib'axik ronojel na'oj; ruma k'a ri' wakami k'o jun rutz'ib'axik ri ajilab'äl pa qach'ab'äl. Achi'el ri: jun ka'i', oxi'...

Chuqa' yalan k'atzinel nqatzu' chi ri maya' ajilab'äl ruch'aron ri pa nima'q taq xak:

- 1 Ri nab'ey ruxak ri ajilab'äl ntz'ukutäj el rik'in ri wa'ix nb'ek'is pa b'elejlajuj.
- 2 Ri ruka'n xak ntikir el rik'in ri juk'al k'a b'elejlajk'al b'elejlajuj, ke ri' eqal njote' ri etamab'äl.

Tqakanoj pa taq sik'iwuj ri rutz'aqat re jujun xak.

- Ri tijonel nusöl achike rub'eyal runuk'un ri' ri ajilab'äl.
- Ri tijoxela' nkitz'aqatisaj pa kitz'lb'awuj rutz'aqat ri jujun xak.



Rokisaxik ri maya' cholajib'äl

Ri rucholajem ri maya' ajilab'äl, janila chuqa' nim rejqalem ruma nk'atzin richin nqanuk' ruk'ojlem qasamaj chuqa' jalajöj qana'oj.

Keqatz'ib'aj re jujun tz'etebäl re':

									Rulaj
								Rub'elej	
							Ruwaqxaq		Rub'elejlaj
						Ruwuq		Ruwaqxaqlaj	
					Ruwaq		Ruwuqlaj		
				Ro'		Ruwaqlaj			
			Rukaj		Rolaj				
		Rox		Rukajlaj					
	Ruka'n		Roxlaj						
Nab'ey		Rukab'laj							
	Rujulaj								

Ri rucholajem ri ajilab'äl tikirel nqokisaj ke re':
 B'enäq pa rox juna ri nuchaq'.
 B'enäq pa rulaj xak ri wana' pa nimatijob'äl.

Tqatz'ib'aj ch'aqa' chik na'oj akuchi nqokisaj ri cholajilab'äl

- . Ri tijonel chuqa' ri tijoxela' nkisik'ij ri na'oj tz'ib'atäl pa ruwi ri cholajilab'äl ri maya' ajilab'äl.
- .. Ri tijonel nutz'aqatisaj ri na'oj pa ruwi' ri na'oj e k'o pa kajtz'uk.
- ... Ri tijoxela' nkltz'ib'aj na'oj pa taq b'ab' akuchi nokisäx wi ri ajilab'äl.

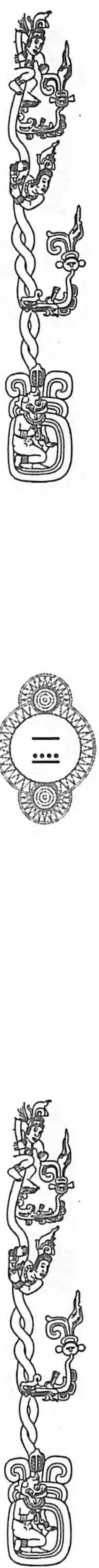

Etab'äl



Ri pa maya' na'oj k'o k'iy rub'eyal richin yatajilan, e k'o jun molaj re' akuchi ye'okisäx ri na'oj pa molaj. Re' nb'e'el chi tzij, chi nab'ij natz'ib'aj jun tzij yerumol e k'iy chikopi', winaqi' chuqa' wachinäq.

Keqatz'eta jun ka'i' oxi' na'oj



Taya' apo jumoq' kixim la äk'.

Nub'ij chi ma junayon ti ixim naya' apo.

Ri tzij jumoq', nuq'alajrisaj chi k'iy ri ixim.

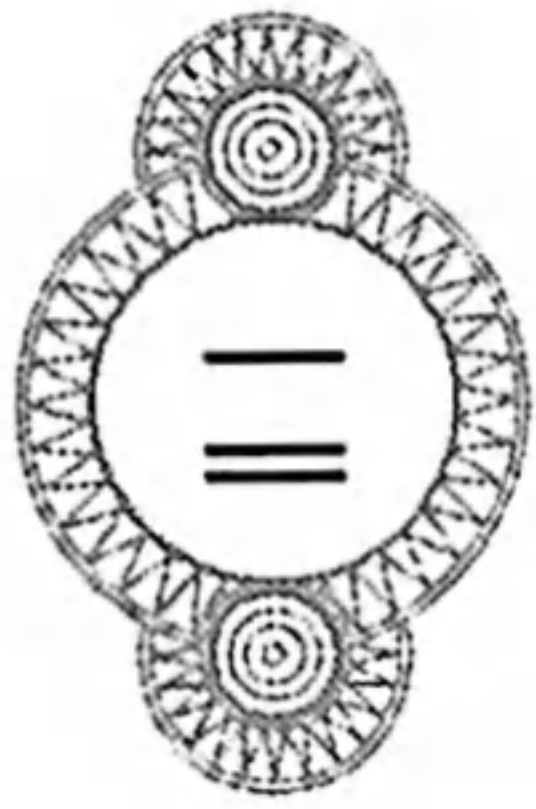

Xinloq' jun b'oraj wichaj. Ri tzij b'oraj, nuq'ajuj chi man xa xe ta jun raqän.

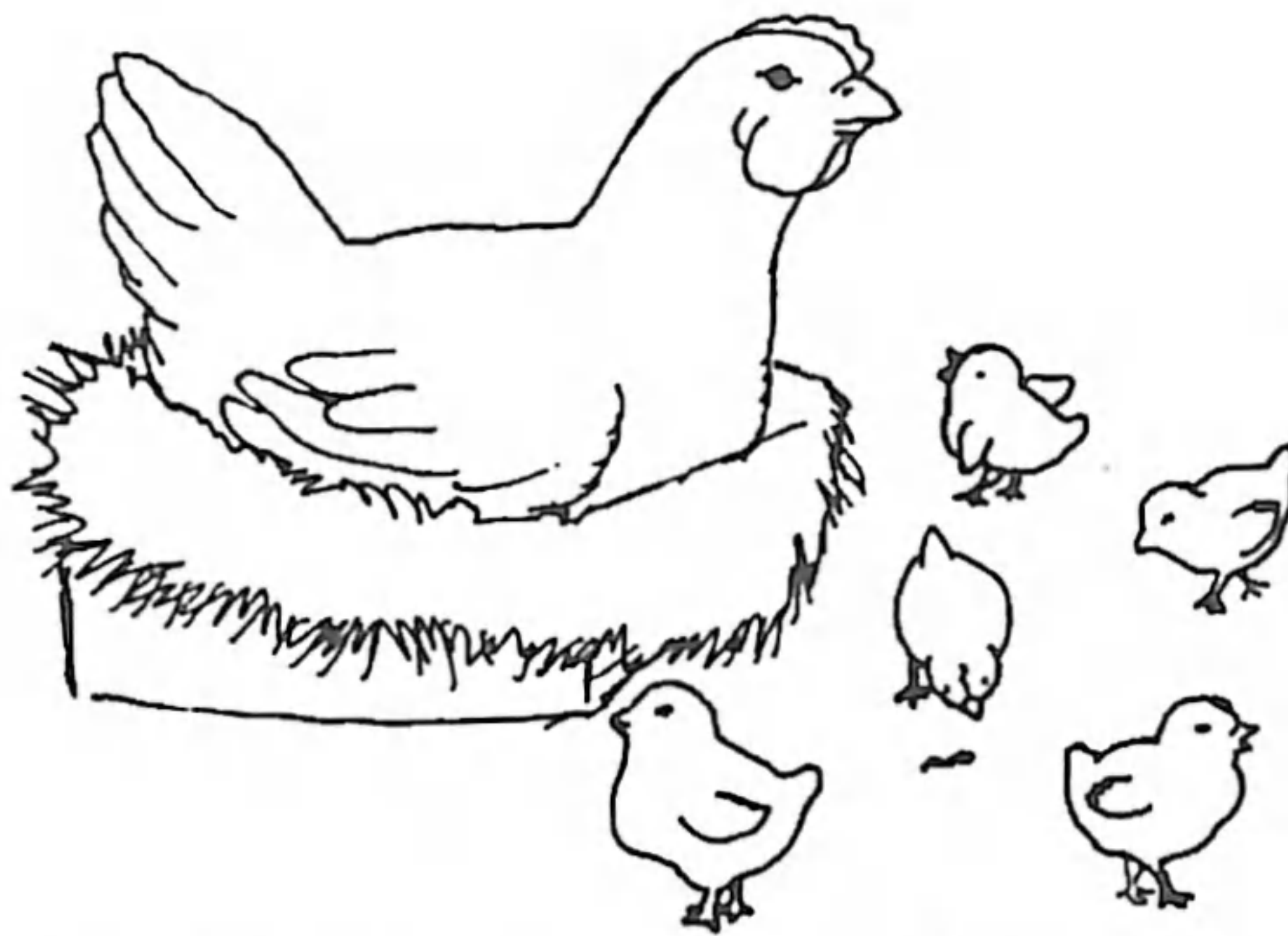

Xe'aläx jupuq äk' chi rochoch ri lxchel.

Ri tzij jupuq, nuq'ajuj jun molaj taq äk'.

Tqakanoj chuqa' tqatzib'aj ch'aqa chik tzij ri nuya' na'oj pa molaj. Ütz yeqak'ulb'ej ri qate' qatata'.

Two sets of horizontal lines for writing practice.

• Ri tijonel chuqa' ri tijoxela' nkisik'ij ri na'oj tz'lb'atäl pa ruwi' ri rucholajem ri maya' ajilab'äl.
•• Ri tijonel nutz'aqatisaj na'oj pa ruwi' ri e k'o pa kajtz'uk.
••• Ri tijoxela' nkitz'ib'aj na'oj pa taq b'ab' akuchi nokisäx wi ri ajilab'äl.



Rutz'aqat na'oj pa ruwi' ri maya' ajilab'äl

Pa maya' na'oj yalan nïm rejqalem ri ajilab'äl, ruma pa qak'aslem ronojel ri nqab'än k'o chi pa rub'eyal nel, k'o chi tz'aqät nel. We nqapab'a jun jay, we nqab'än achib'äl, we nqanuk' jun na'oj; xa b'a achike samaj nqana'ojij nqatz'uk el, k'atzinel k'o ruchojmilal ja ri rusamaj nub'än ri ajilab'äl.

K'atzinel nqanataj chi e ja ri ojer qati't qamama' ri e maya' kib'i', e ja ri' xena'ojin xetz'uku ri nb'ix wa'ix chi re. Re na'oj re', yalan ta nuyäk qak'u'x ruma nïm ri ketamab'al ri ojer qati't qamama'.

Tqasolo', tqatz'ib'aj pa molaj, achike k'o chi nqab'än röj richin jantape' nqak'asb'a ri maya' ajilab'äl.

Achike k'o chi nub'än ri tijob'äl richin ruya' ruchuq'a' ri na'oj pa ruwi' ri maya' ajilab'äl.

- Ri tijoxela' nkisik'ij ri na'oj tz'ib'atäl chuwäch re sik'iwuj.
- Ri tijonet nutz aqatisaj ri na'oj pa ruwi' ri na'oj pa ruwi' ri ajilanik.
- Ri tijoxela' nkitz'ib'aj na'oj richin runimirisaxik ri maya' ajilab'äl.

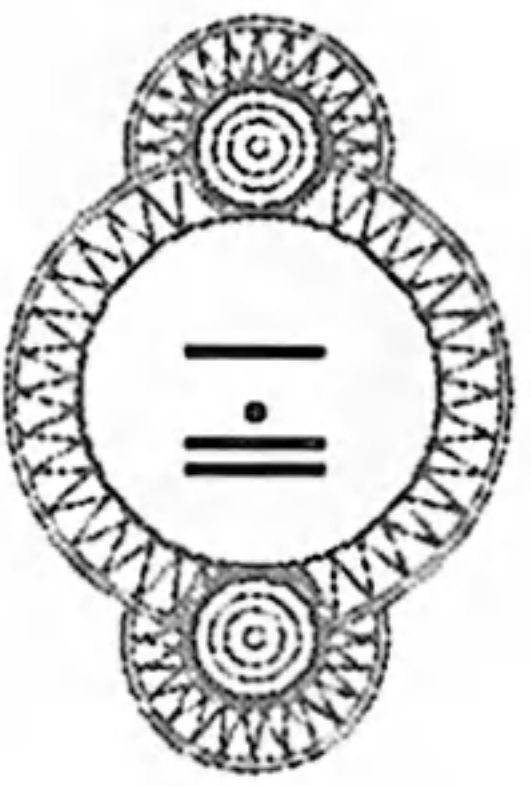



Rujikib'axik ri maya' ajilab'äl

Tqatz'ib'aj jun ka'i' qana'oj pa ruwi' ri rejqalem ri maya' ajilab'äl.



A large rectangular box with horizontal lines for writing, and a small illustration of a pen nib in the bottom right corner.

Tqab'ana' rachib'äl ri etal yerokisaj ri maya' ajilab'äl

Three empty rounded rectangular boxes arranged horizontally, intended for drawing or writing.

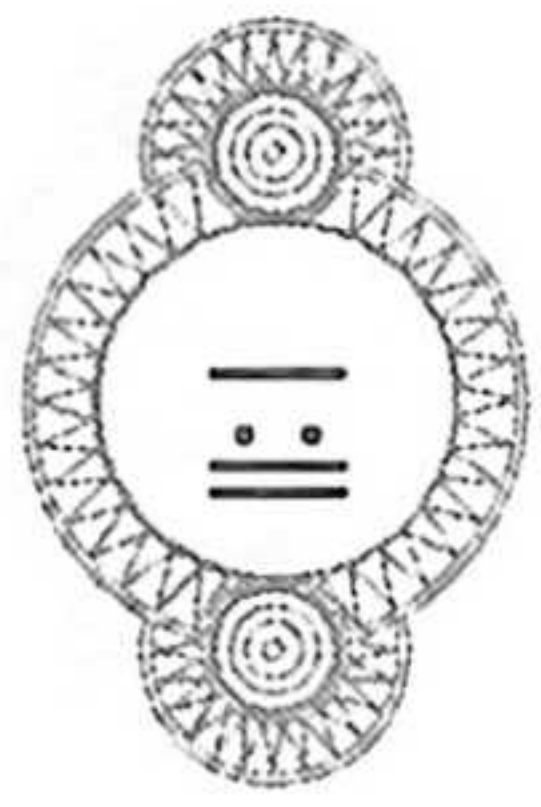

Tqatz'ib'aj ri maya' ajilab'äl pa taq k'al; kak'al k'a pa julajk'al.

A large grid with 5 columns and 5 rows. The middle row is shaded gray, and the middle column is also shaded gray, creating a cross-like pattern.

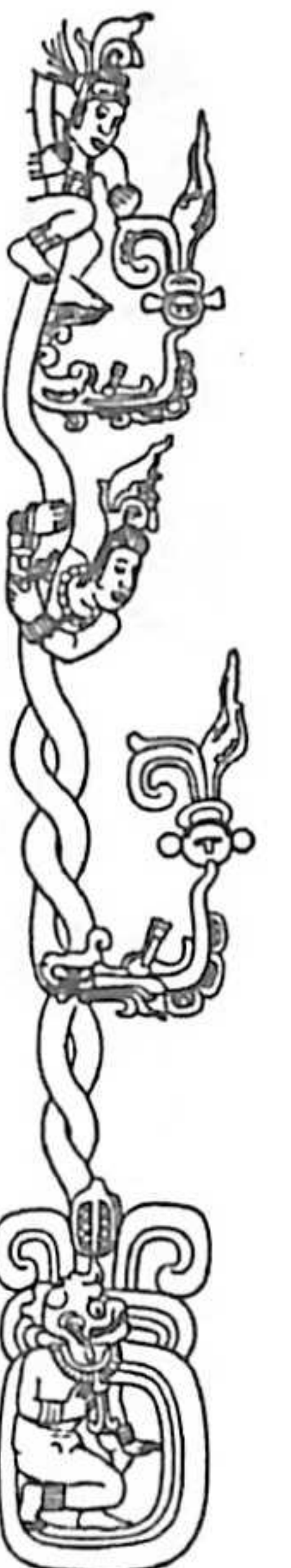

- Ri tijoxela' nkitz'ib'aj jun na'oj, tikirel b'ab', we mani üt'z kokoj taq na'oj.
- Ri tijoxela' nkib'än rachib'äl ri taq retal ajilab'äl.
- Ri tijoxela' nkitz'ib'aj maya' ajilab'äl chuqa' ri rub'ixik. Tkokisaj ri nab'ey rub'eyal.



Nqak'ut chiwäch ri na'oj Xqetamaj.

¿Achike taq retal yerokisaj ri maya' ajilab'äl?
Tqatz'ib'aj pa taq kajtz'uk.

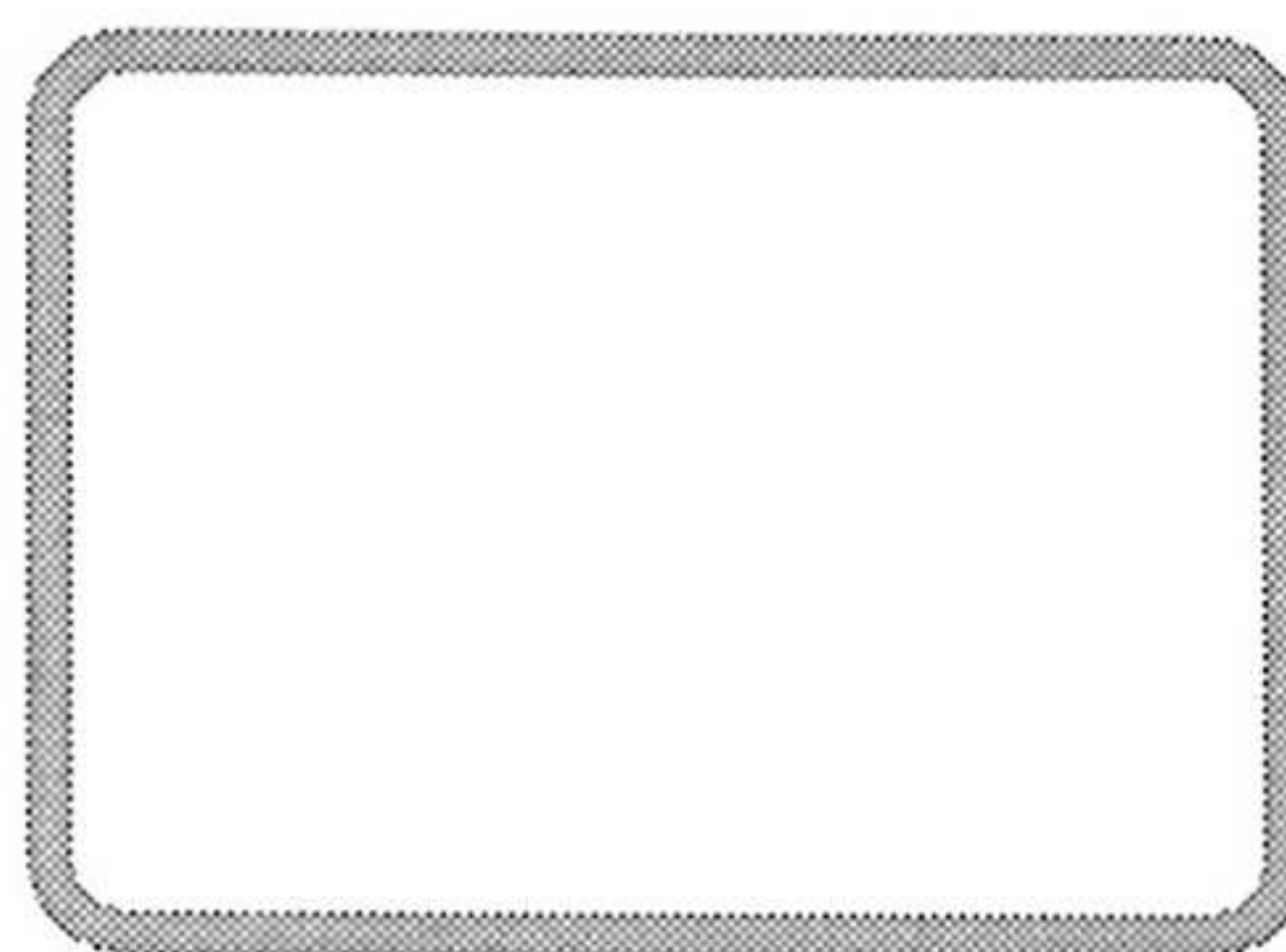
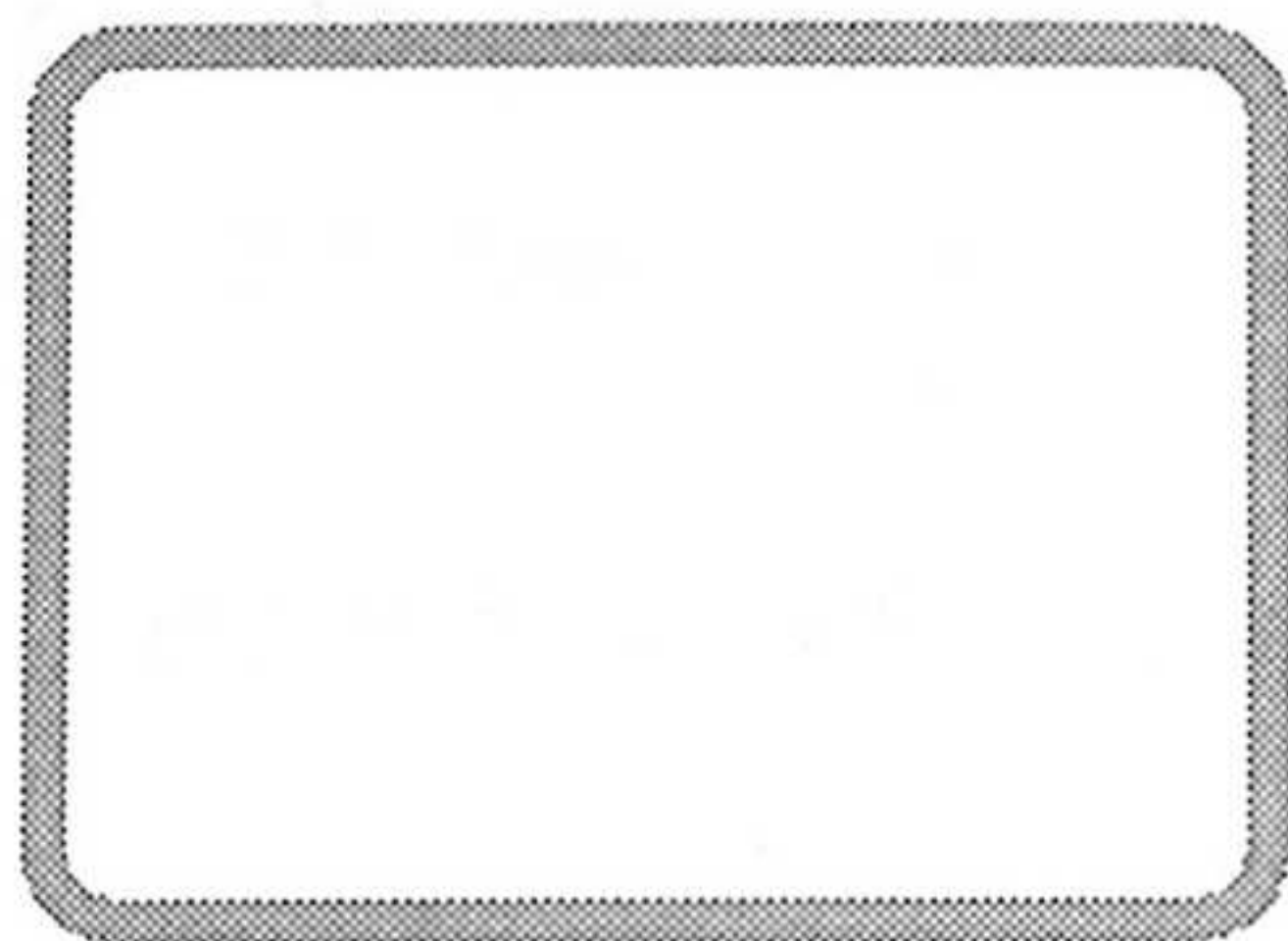
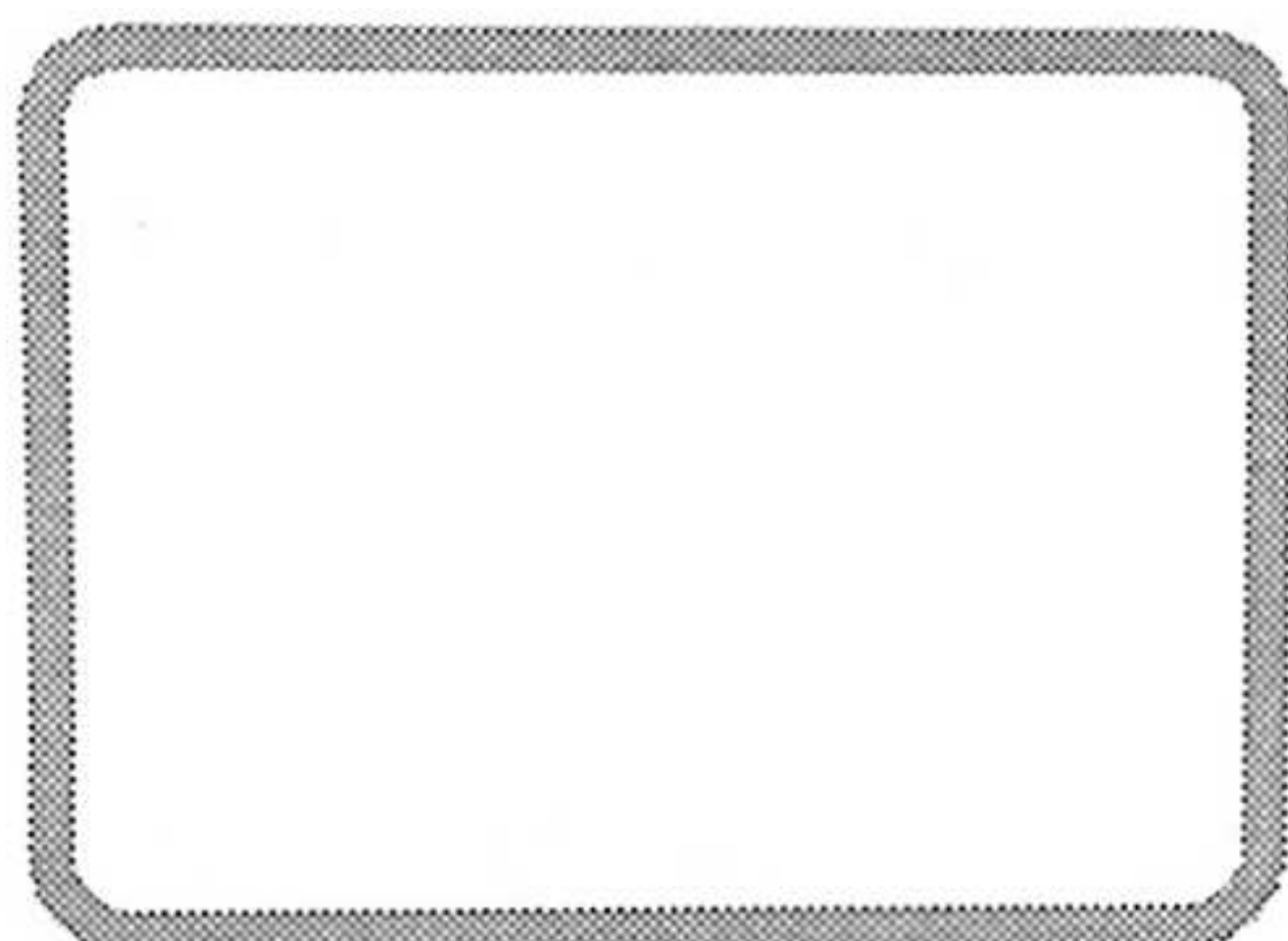

Tqatz'ib'aj kib'i' ri molaj winaqi' xena'ojin xetz'uku ri wa'ix.

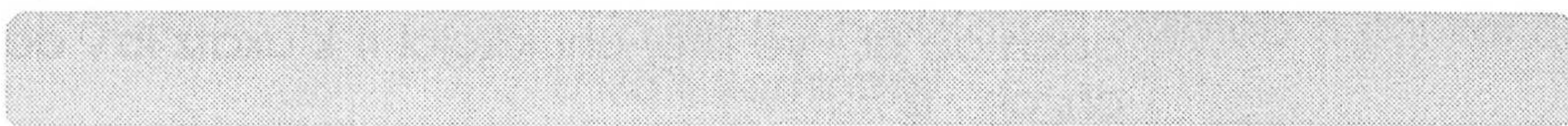

Tqatzi'b'aj re ajilab'äl re':

20

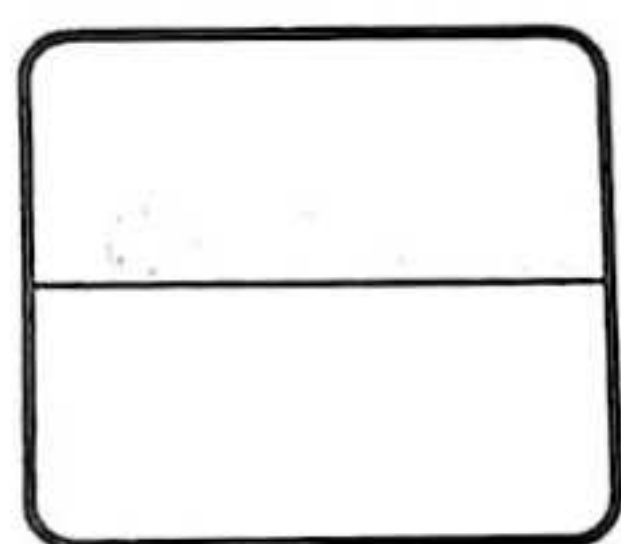

120

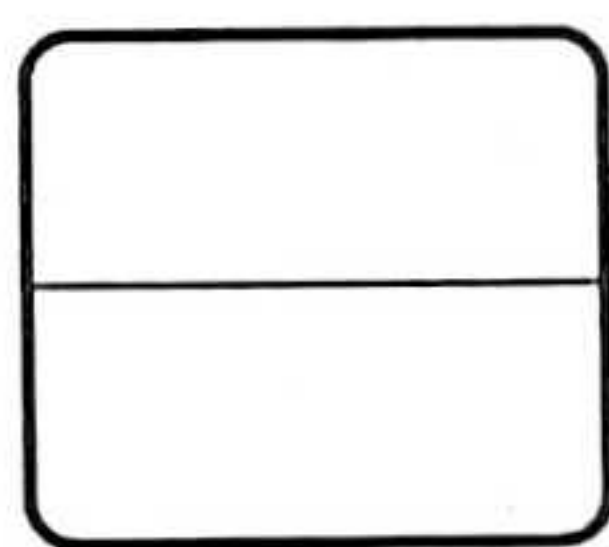

80

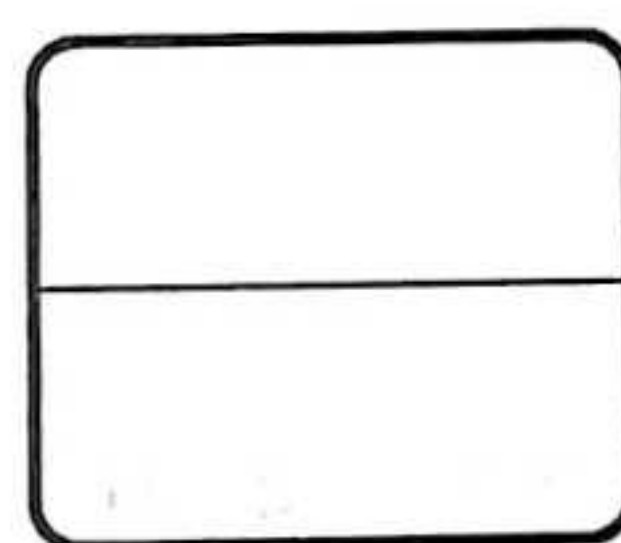

180

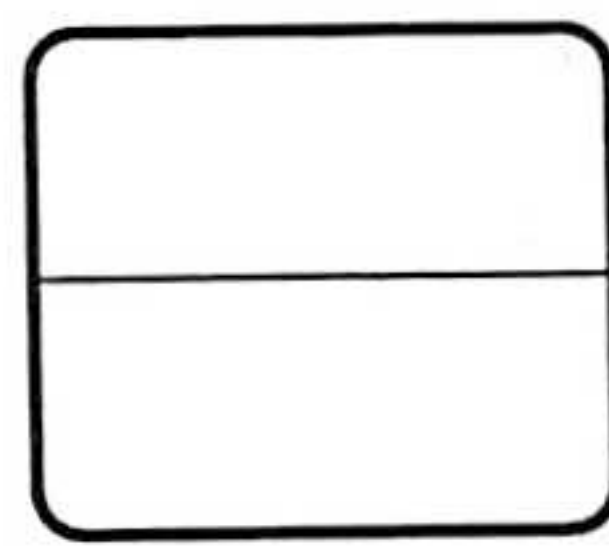

Tqatz'ib'aj pa taq b'ab', oxi' rub'eyal richin rokisaxik ri ajilanik
pa molaj.

Ri tijonel nuya' rutzijol achike rub'eyal nkib'än ri jujun k'utunik. ri nab'ey rub'eyal.

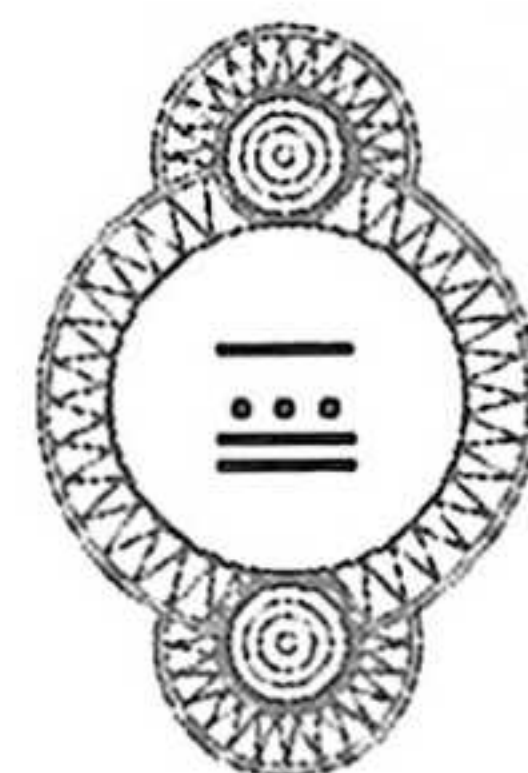

Ch'uti Choltzij



Ach'alalri'il	Ja ri' ri jun molaj winaqi' kach'alal ki' e k'o wi ri ati't mama', te'ej tataj chuqa' ri alk'walaxela'.
Ajb'aaq	Jun winäq ri nuya' pa rub'eyal ri rub'aaqil ri winäq töq k'o kajtajik.
Ajilab'äl	Rubeyal richin yatajilan.
Al	Ja re' kib'i' ri taq ajxik' chikopi' ri yeya'o rutzijol ri rupeteb'al ri jäb'.
B'alam Ya'	Ke ri' rub'i' pa qach'ab'äl ri tinamit Santa Cruz Balanyá.
Ch'akultz'ib'	E ja re' ri tz'ib' ri nkiya' ruch'akulal rutz'ib'axaik ri qach'ab'äl, ye'ilitäj chi kikojol ri k'uxatz'ib', achi'el ri ch, ch', tz', ...
Chi Xot	Ke ri' rub'i' pa qach'ab'äl ri San Juan Comalapa.
Chinamital	Ojer kan ja ri' rub'i' jun winäq ri nuk'waj kib'ey jun molaj winaqi'.
Cholq'ij	Rucholajil ri q'ij. Ja re' xkokisaj ri ojer maya' winaqi', richin xkitz'ët ri rub'eyal ruximon ri' ri kajulew.
Etab'äl	Rub'eyal richin nawetaj ri ramaj, ri q'ij, ri wachinäq (chuxtäq)
Ichinanel b'i'aj	Ja re' ri taq rutz'aaqat tzij, yekokisaj ri b'i'aj. (nu-tz'i', w-awän)
Jalb'i'aj	Ja re' ri njalwachin richin ri b'i'aj.
Jux	Ja re' choj pa ruwi' nya'ox ri tz'ib'anik.
Kaji' Imox	Rub'i' jun chi ke ri ruk'isib'äl kamöl taq b'ey pa kaqchikel tinamit.
Kajtz'uk	Jun achib'äl ri k'o kaji' ruchi'.
Kajulew	Rub'i' ronojel ri k'o chi kaj chuqa' pa ruwach'ulew.
Kamelanik	Rub'eyal naya' kiq'ij kejqalem ri winaqi' nima'q chik kijuna'.
Kaqulew	Kilewal ri kaqchikela' winaqi'.
Kematz'ib'	K'ak'a samajib'äl nkokisaj ri tz'ib'anela' pa taq samajay, chuqa' pa taq jay.
Kiq'ij Kejqalem winaqi'	Ke re' nqab'ij chi re pa qach'ab'äl ri tzij nan, tat, ya, ma...
K'ulunel	Jun winäq ri nuk'ul apo rutzij jun k'utunel pa jun k'utunik.

K'utunel	Jun winäq ri npeyox el richin nb'eruk'utuj jun q'opoj.
Nuq'ajuj	Jun ch'ik rub'ixikil ri na'oj, nb'e'el chi tzij. Ri nb'ek'un wi jun na'oj.
Pach'un tzij	Jun rub'eyal tzijonem akuchi nkotz'ijäx rutz'ib'axik.
Q'aptzij	Rutz'ib'axik jun ko'ol na'oj.
Samaj pa q'uch	Rub'eyal samaj akuchi nkimol ki' ri winaqi' chi rub'anik.
Solojsamaj	Rub'eyal richin nab'an jalajöj samaj, richin rujikib'axik jun na'oj.
Tinamital	Kulewal jun molaj tinamit.
Tok'är	Ja re' ri jun etz'ab'al nkijotob'a chi kaj ri ak'wala' pa kiq'ij kaminaqi'.
Latz' K'uxatz'ib'	E ja re' ri k'uxatz'ib' kik'wan ka'i' taq tz'uj pa kiwi'.
Tz'aläm Tz'ib'ab'al	Jun samajib'al ri nrokisaj ri tijonel richin ntz'ib'an chwäch.
Tz'ib'	Ja re' rachib'al ri jujun k'oxomal nrokisaj ri jujun tzij.
Ch'ach'el k'uxatz'ib'	E ja re' ri k'uxatz'ib' man kik'wan ta ka'i' taq tz'uj.
Wachinäq (chuxtäq)	Ronojel ri tikirel yechap, ye'okisäx.
Wa'ix	Jun ajilab'al, ri nuq'ajuj ronojel chuqa' nuq'ajuj rutikirib'al jun na'oj, jun samaj.
Xupüy	Jun achib'al ri nketz'ab'ej ri ak'wala', chuqa' nokisäx richin wiqoj.

Retal wuj xenik'öx, xek'ulb'ëx



Rodríguez G., José Obispo.

Rutz'ib'axik ri Kaqchikel. Manual de Redacción Kaqchikel. Cholsamaj. Guatemala. 1994.

Salazar T., Manuel de J.

Ruk'ux Maya' Na'oj. Valores de la Filosofía Maya. Guatemala. 1998.

García Matzar, Pedro (Lolmay).

Rukemik ri Kaqchikel Chi'. Gramática Kaqchikel. Cholsamaj. Guatemala. 1997

Chacach Cutzal, Martin.

Rujotay Kaqchikel Ch'ab'äl. Escribamos el Kaqchikel. Guatemala. 1999.

Programa Nacional de Educación Bilingüe-PRONEBI.

Matemática Tercer Grado. Maya Kaqchikel. Guatemala. 1991.

Proyecto de Desarrollo SANTIAGO PROMEM/UNESCO.

Programa de Formación y Capacitación de Educador@s comunitari@s Mayas. Guatemala, junio de 1998.

Fundación Kaqchikel. Andrea Sacbajá

Ruka'n Kaqchikel Sik'itz'ib'anem. Lectoescritura Kaqchikel No. 2. Guatemala. 2001.

Comunidad Lingüística Kaqchikel.

K'ak'a' Taq Tzij richin Retamab'alil ch'ab'äl. Neologismos Artes del Idioma. Guatemala. 1997.

Academia de Lenguas Mayas de Guatemala.

Usemos Nuestro Calendario Maya. Paxil 2001.

Comunidad Lingüística Kaqchikel-ALMG

Maya' Nimab'äl K'u'x pa Kaqchikel Tinamit. Talleres gráficos de Ediciones especializadas. Guatemala. 2002.

Cruz Corzo, Héctor Felipe.

SEMENTERA. Libro Tercero de Lectura. Guatemala. Revisado 1989.

Mucía Batz, José.

JUN RAQÄN. La Cosmovisión y los Números. Guatemala. 1997.



*Programa de Educación Bilingüe Intercultural:
Incidencia en la Reforma Educativa desde el aula
Contrato de subvención N° ONG-PVD/2002/020-679*

Con el apoyo de:

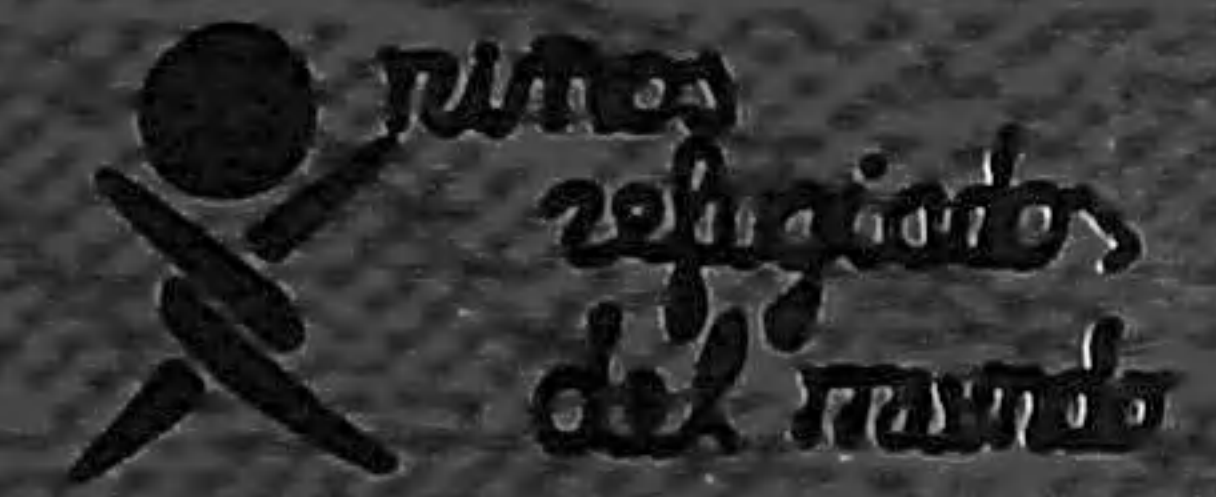

Biblioteca Central
USAC



4701257828